

# Operator's Manual

# ASCO® Series 300 Automatic Transfer Switches H-design 600 through 1200 amps

## **⚠ DANGER**

**DANGER** is used in this manual to warn of high voltages capable of causing shock, burns, or death.

## **⚠ WARNING**

**WARNING** is used in this manual to warn of possible personal injury.

## **⚠ CAUTION**

**CAUTION** is used in this manual to warn of possible equipment damage.

An experienced licensed electrician must install the ATS.

Refer to the outline and wiring drawings provided with ASCO Series 300 ATS for installation details.

## TABLE OF CONTENTS

	section
INSTALLATION .....	1
SEQUENCE OF OPERATION .....	2
TESTING & SERVICE .....	3
ADJUSTMENTS .....	4
CONTROL FEATURES .....	5
INDEX .....	back cover



600, 800, 1000 amp. sizes



1200 amp. size

**ASCO** Power Technologies®

50 Hanover Road, Florham Park, New Jersey 07932-1591 USA  
For sales or service call 1 800 800-2726 (ASCO) www.ascopower.com

**381333-201 F**

ASCO POWER TECHNOLOGIES CANADA PO Box 1238, 17 Airport Road, Brantford, Ontario, Canada N3T 5T3  
telephone 519 758-8450, fax 519 758-0876, for service call 1 888 234-2726 (ASCO) www.asco.ca

**EMERSON**  
Network Power

## Nameplate

The Transfer Switch nameplate includes data for each specific ASCO Series 300 ATS. Use the ATS only within the limits shown on this nameplate.

## Catalog Number Identification

A typical Catalog Number is shown below with its elements explained. The example is for a Series 300 ATS with switched neutral, 3 pole, 600 amp, 480 V, in a Type 1 enclosure:

H 300		B	3	600	N	1	C
Neutral		Phase Poles	Amperes	Voltage		Controller	Enclosure
B – switched		2 – single Ø	600	C 208	L 440	1 – standard	C – type 1
C – overlapping		3 – three Ø	800	D 220	M 460	1X – if	F – type 3R
blank – solid			1000	E 230	N 480	accessories	G – type 4 *
			1200	F 240	P 550	ordered	L – type 12 *
				H 380	Q 575		blank – open type
				J 400	R 600		
				K 415			

\* available 600 – 1000 amp. sizes only

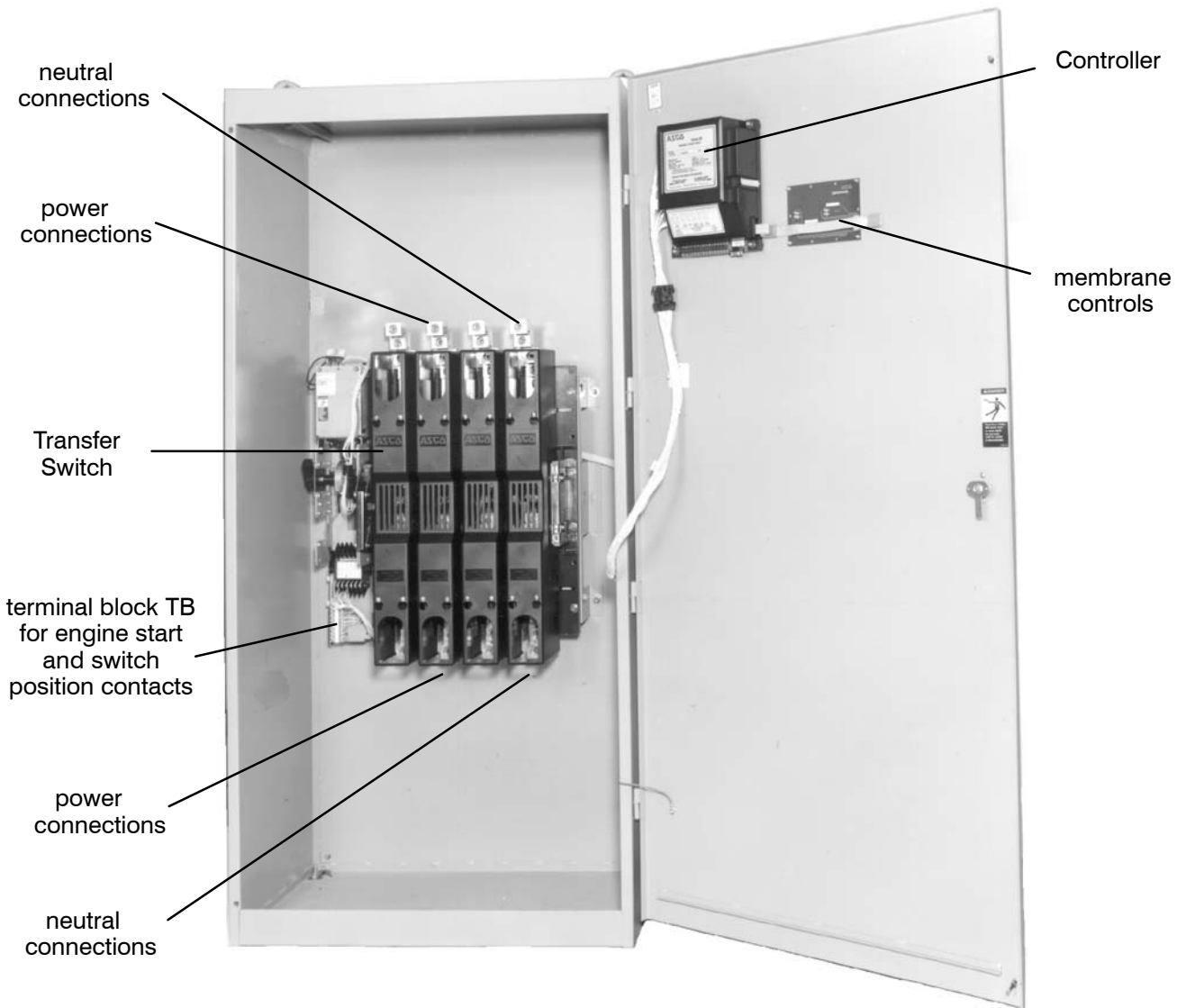

600 amp. size in typical enclosure with location of customer connections

ASCO Series 300 Automatic Transfer Switches (ATs) are Listed under Underwriters Laboratories UL 1008 Standard for Safety for Automatic Transfer Switches. All control features are UL Component Recognized, which assures that ASCO automatic transfer switches meet OSHA Safety Requirements and will be acceptable to electrical inspectors.

ASCO Series 300 Automatic Transfer Switches are suitable for emergency and standby system applications. They meet emergency system rating requirements as defined in National Electrical Code (NEC) Article 700 and UL 1008. Also, they are suitable for the requirements of NEC Article 517 – Health Care Facilities, NEC Article 701 – Legally Required Standby Systems, NEC Article 702 – Optional

Standby Systems, NFPA 99 Health Care Facilities, and NFPA 110 Emergency and Standby Power Systems.

### Rating Label

Each automatic transfer switch contains a rating label to define the loads and fault circuit withstand / closing ratings. Refer to the label on the transfer switch for specific values.

**⚠ WARNING**

**Do not exceed the values on the rating label. Exceeding the rating can cause personal injury or serious equipment damage.**

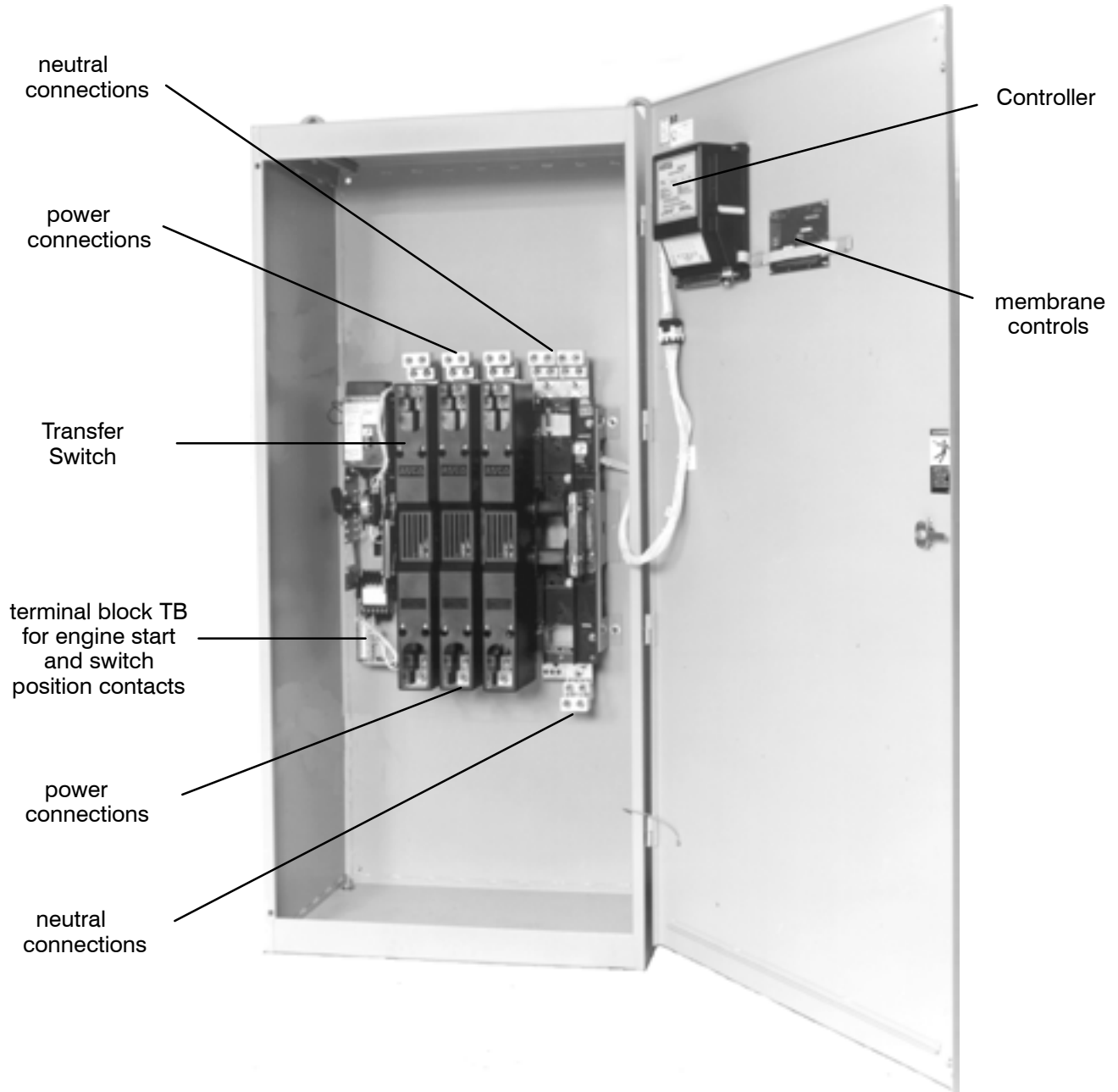

800 and 1000 amp. size in typical enclosure with location of customer connections

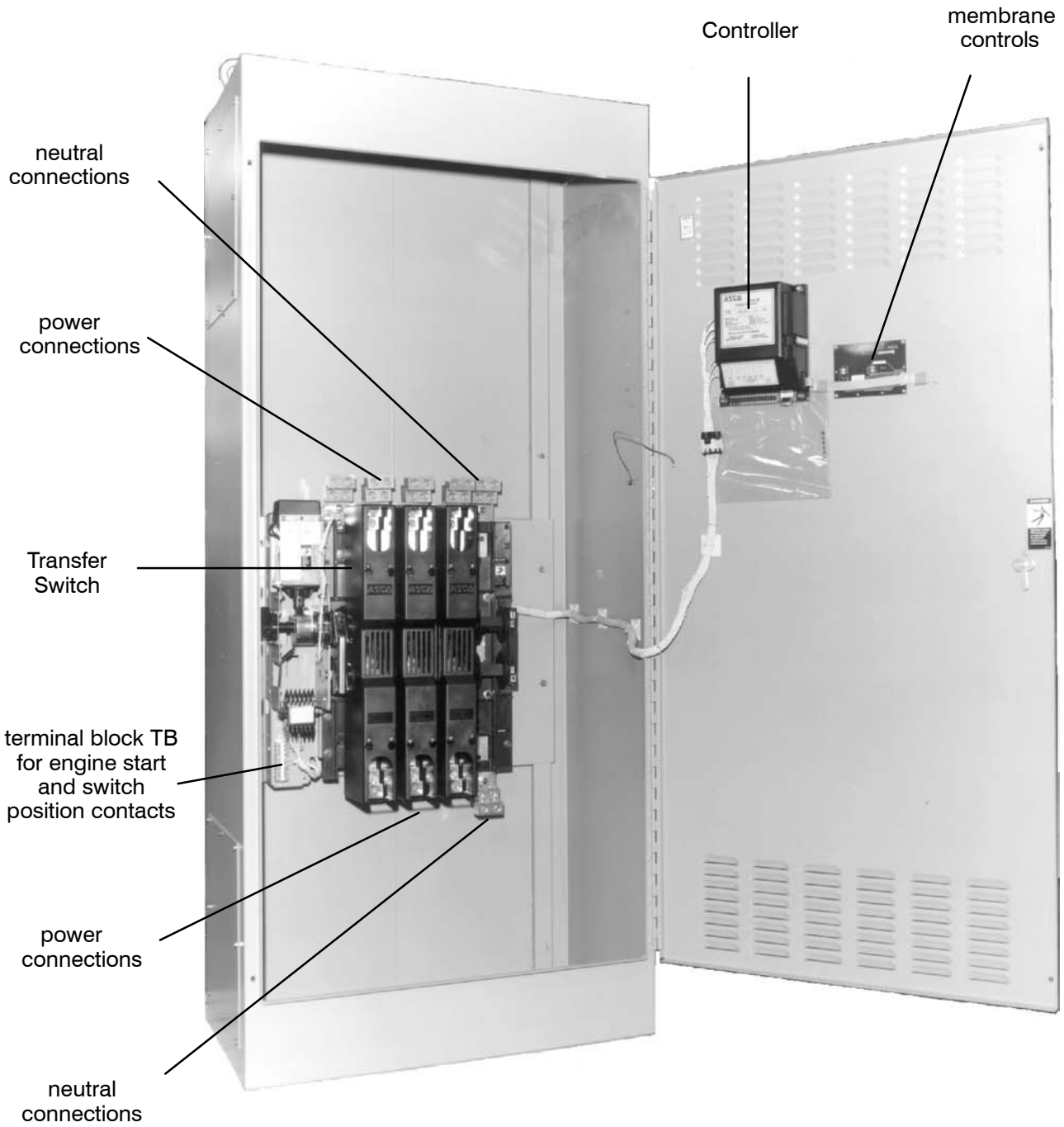

1200 amp. size in typical enclosure with location of customer connections

## SECTION 1 INSTALLATION

Series 300 Automatic Transfer Switches are factory wired and tested. Installation requires skid removal then securing the enclosure to the supporting foundation.

### Remove the Shipping Skid

Open the front door and remove the four lag screws (2 in front, 2 in rear) securing enclosure to the wood skid.

### Supporting Foundation

The supporting foundation for the enclosure must be level and straight. Refer to the applicable enclosure outline drawing included with the Series 300 for all mounting details including door opening space.

If bottom cable entry is used, the foundation must be prepared so that the conduit stubs are located correctly. Refer to the enclosure outline drawing for specified area and location. Provide cable bending space and clearance to live metal parts. When a concrete floor is poured, use interlocking conduit spacer caps or a wood or metal template to maintain proper conduit alignment.

### Mounting

Refer to the applicable enclosure outline drawing furnished with this switch and mount the Series 300 according to details and instructions shown on diagram.

### Line Connections

Refer to the Wiring Diagram provided with your Series 300 ATS. All wiring must be made in accordance with the National Electrical Code and local codes.

It is unnecessary to remove pole covers from the transfer switch. If you do remove them, reinstall them carefully.

### DANGER

**De-energize the conductors before making any line or auxiliary circuitry connections. Be sure that Normal and Emergency line connections are in proper phase rotation. Place engine generator starting control in the OFF position. Make sure engine generator is not in operation.**

### Testing Power Conductors

Do not connect the power conductors to the ASCO Series 300 transfer switch until they are tested. Installing power cables in conduit, cable troughs and ceiling-suspended hangers often requires considerable force. The pulling of cables can damage insulation and stretch or break the conductor's strands. For this reason, after the cables are pulled into position, and before they are connected, they should be tested to verify that they are not defective or have been damaged during installation.

### CAUTION

**Protect the automatic transfer switch from construction grit and metal chips to prevent malfunction or shortened life of the ATS.**

### Connecting Power Conductors

After the power cables have been tested, connect them to the appropriate terminal lugs on the transfer switch as shown on the wiring diagram provided with this Series 300. Make sure the lugs provided are suitable for use with the cables being installed. Standard terminal lugs are solderless screw type and will accept the wire sizes listed on the drawings provided with the Series 300. Be careful when stripping insulation from the cables; avoid nicking or ringing the conductor. Remove surface oxides from cables by cleaning with a wire brush. When aluminum cable is used, apply joint compound to conductors. Tighten cable lugs to the torque specified on rating label.

### Controller Ground

A grounding wire must be connected to the controller's lower left mounting stud. Because the controller is mounted on the enclosure door, a conductive strap must be used between the enclosure and the door. This connection provides proper grounding which does not rely upon the door hinges.

### Harnesses

The transfer switch is connected to the left side of the controller by a plug-in harness (two plugs).

# INSTALLATION *(continued)*

## Engine Starting Contacts

Customer connections for engine control contact and TS auxiliary contacts connections are located on terminal block TB which is mounted on the front lower left of the transfer switch. Refer to wiring diagram provided with the Series 300 ATS and connect the engine start wires to the appropriate terminals. See Figure 1-1 and Table A.

Table A. Engine start connections.

When normal source fails	Terminals on transfer switch
contact closes	TB1 and TB2
contact opens	TB1 and TB3

### Auxiliary Circuits

Connect auxiliary circuit wires to appropriate terminals on transfer switch terminal block TB as shown on the wiring diagram provided with this Series 300 Automatic Transfer Switch. Make the necessary auxiliary connections by referring to Section 5, Control Features.

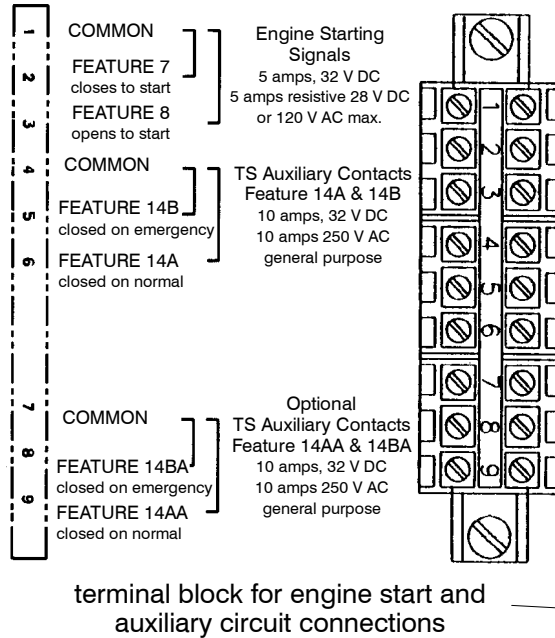

left side of transfer switch

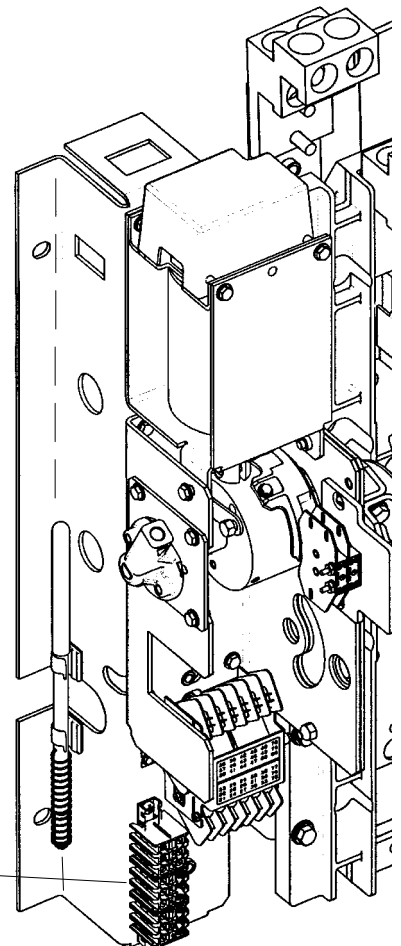

terminal block for engine start and auxiliary circuit connections

### Connections to Controller for other Control Features

(located on bottom of Controller)

Figure 1-1. Engine start and auxiliary circuit terminal block TB located on the transfer switch.

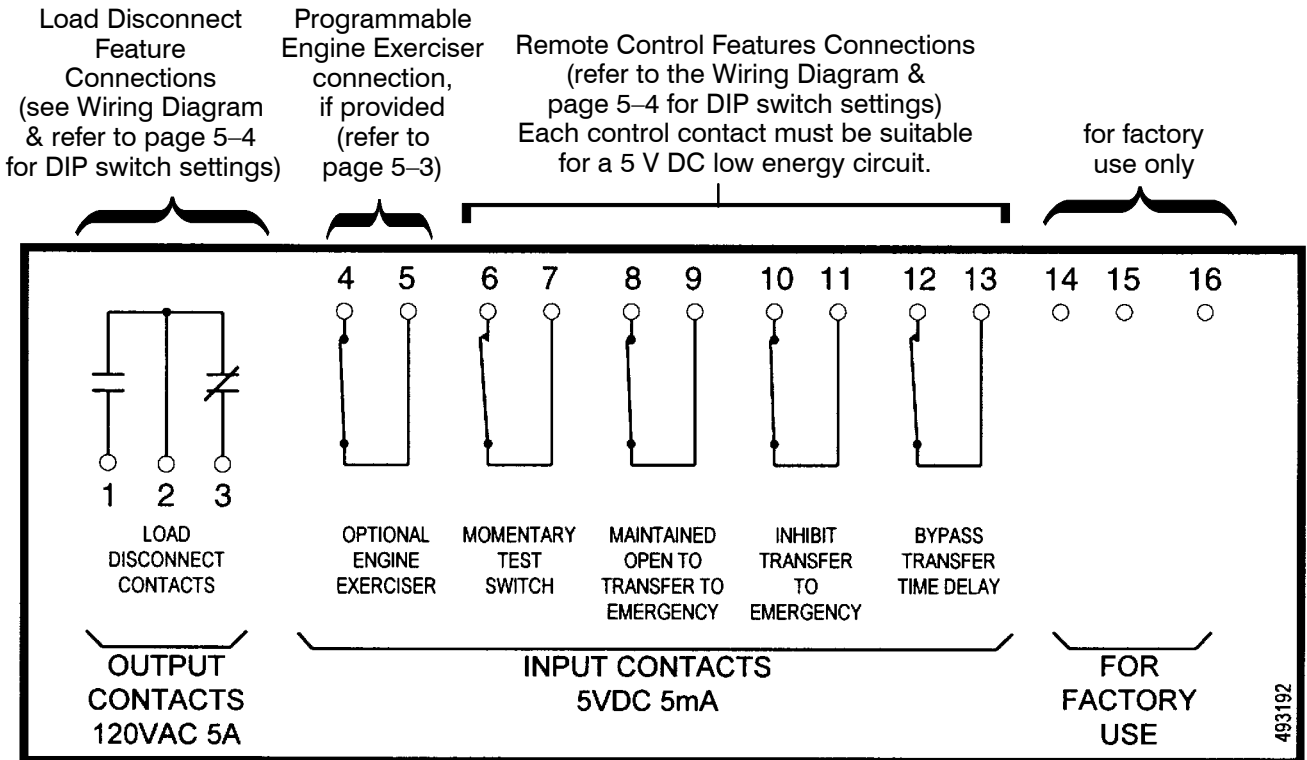

Figure 1-2. Input / output label on the Controller showing possible connections to the lower terminal block.

# INSTALLATION *(continued)*

## Functional Test

The Functional Test consists of three checks: manual operation, voltage checks, and electrical operation.

**⚠ CAUTION**

**Do these checks in the order presented to avoid damaging the automatic transfer switch.**

Read all instructions on the Wiring Diagram and labels affixed to the automatic transfer switch. Note the control features that are provided and review their operation before proceeding.

### 1 – Manual Operation Test

A detachable maintenance handle is provided on the frame of the Transfer Switch for maintenance purposes only. Manual operation of the transfer switch should be checked before it is energized (operated electrically).

**⚠ WARNING**

**Do not manually operate the transfer switch until both power sources are disconnected: open both circuit breakers.**

1. After deenergizing both power sources, open the enclosure door. Locate and remove the maintenance handle from the clips on the left side of the transfer switch frame. Insert the handle into the hole in the molded hub on the left side of the operator. See Figures 1-3 and 1-4 and Table B.
2. Move the maintenance handle up or down as shown to manually operate the transfer switch. It should operate smoothly without any binding. If it does not, check for shipping damage or construction debris.

Table B. Maintenance handle positions.

ATS Position	Handle	Indicators
Normal	 up	 E = O upper contacts open N = C lower contacts closed
Emergency	 down	 E = C upper contacts closed N = O lower contacts open

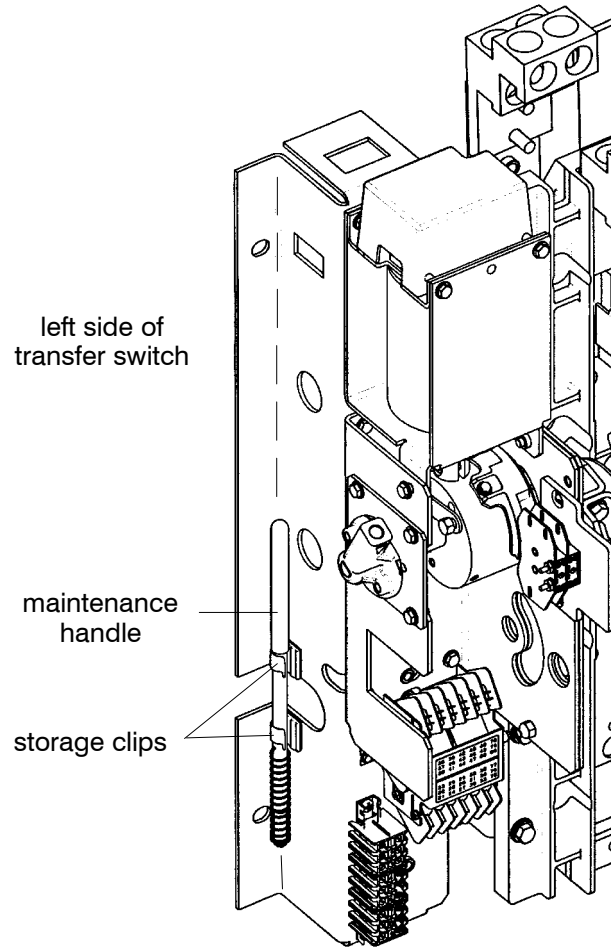
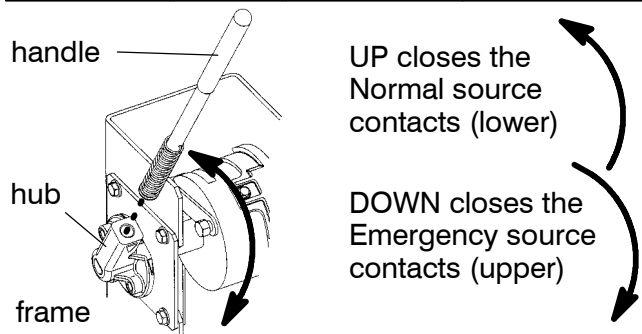

Figure 1-3. Maintenance handle & storage location.

3. Return the transfer switch to the Normal position. Observe that the window indicators (right side) show the top shaft O (open) and the bottom shaft C (closed).  
 Note: If Normal and Emergency connections are reversed this operation is also reversed.
4. Remove the maintenance handle and store it on the frame (left side) in the clips provided.

**⚠ WARNING**

**Verify that the maintenance handle has been removed before proceeding!**

Now continue to 2 – Voltage Checks on next page.

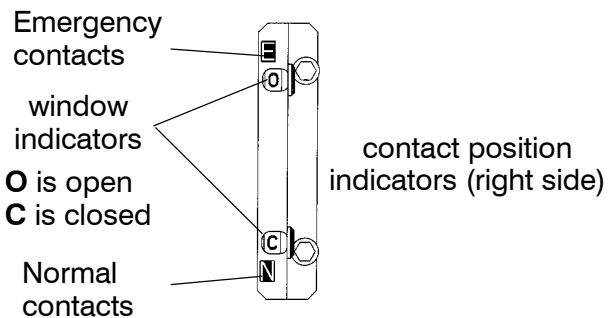

Figure 1-4. Maintenance handle operation and contact position indicators.

# INSTALLATION (continued)

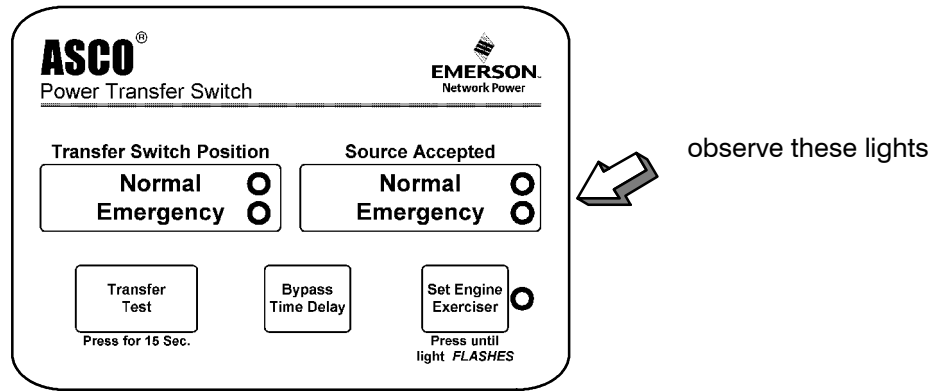

Figure 1-5. Standard controls and indicators.

## 2 – Voltage Checks

First check nameplate on transfer switch; rated voltage must be the same as normal and emergency line voltages.

**⚠ CAUTION**

Verify that the feeders have been connected to the proper lugs.

**⚠ DANGER**

Use extreme caution when using a meter to measure voltages in the following steps. Do not touch power terminals; shock, burns, or death could result !

Perform steps 1 through 6 at the right. Observe the status lights. See Figure 1-5.

- Black circle means light is on.
- White circle means light is off.

\* If necessary, adjust voltage regulator on the generator according to the manufacturer's recommendations. The Automatic Transfer Switch will respond only to the rated voltage specified on the Transfer Switch nameplate.

Also see page 4-1 for the HI-LOW voltage adjust setting in the controller. The LOW setting shifts all voltage settings down 4.2%; for example, 240 V to 230V.

1	Close the normal source circuit breaker. The <i>Normal Transfer Switch Position</i> and the <i>Normal Source Accepted</i> lights should come on.	Source Accepted Normal ● Emergency ○
2	Use an accurate voltmeter to check phase to phase and phase to neutral voltages present at the transfer switch normal source terminals.	
3	Close the emergency source circuit breaker. (Start generator, if necessary.) The <i>Emergency Source Accepted</i> light should come on.	Source Accepted Normal ● Emergency ●
4	Use an accurate voltmeter to check phase to phase and phase to neutral voltages present at the transfer switch emergency source terminals.*	
5	Use a phase rotation meter to check phase rotation of emergency source; it must be the <u>same</u> as the normal source.	A B C 
6	Shut down the engine-generator, if applicable. The <i>Emergency Source Accepted</i> light should go off. Then put the starting control selector switch (on the generator set) in the <i>automatic</i> position. Close enclosure door.	Source Accepted Normal ● Emergency ○

Now continue to **3 – Electrical Operation** on next page.

## INSTALLATION *(continued)*

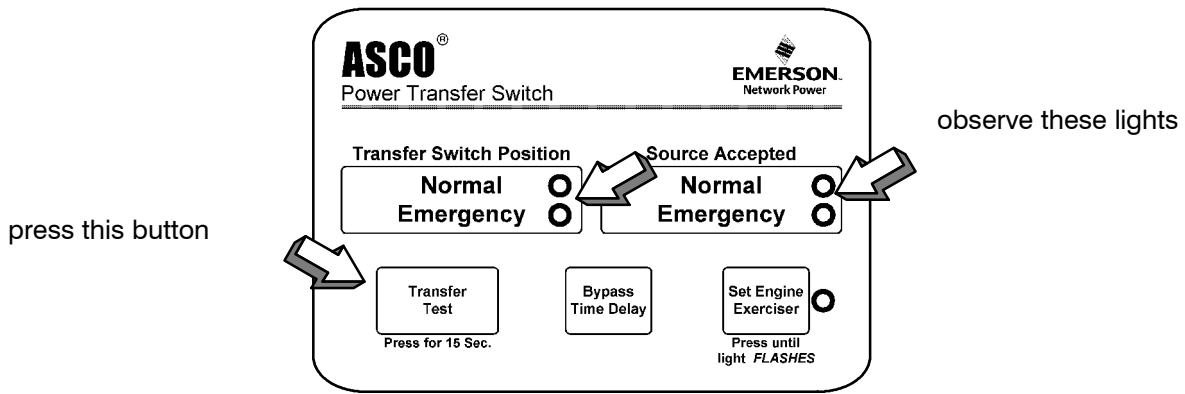

Figure 1-6. Standard controls and indicators.

### 3 – Electrical Operation

This procedure will check the electrical operation of the Automatic Transfer Switch. See Figure 1-6.

**⚠ WARNING**

**Close the enclosure door first !**

#### *Transfer Test*

Both normal and emergency sources must be available and the emergency source generator (if used) must be capable of being started in this procedure.

Perform steps 1 through 8 at the right. Observe the status lights.

- Black circle means light is on.
- White circle means light is off.

**NOTE:** If Motor Load Transfer feature is activated, then transfer may not occur immediately after the respective time delays. Transfer will only occur when the phase relationship between sources is correct.

This completes the Functional Test of the ASCO Series 300 Automatic Transfer Switch. Leave the engine-generator starting control in the *automatic* position.

1	The normal source must be available and the generator must be ready to start. Check that the <i>Normal Source Accepted</i> light is on.	Source Accepted  Normal ● Emergency ○
2	Press and <u>hold</u> the <i>Transfer Test</i> button until the engine starts and runs. This should happen within 15 sec.	Transfer Test
3	The <i>Emergency Source Accepted</i> light should come on.	Source Accepted  Normal ● Emergency ●
4	The transfer switch should transfer to the Emergency position. The <i>Emergency Transfer Switch Position</i> light should come on and the <i>Normal</i> light should go off.	Transfer Switch Position  Normal ○ Emergency ●
5	If the <i>transfer to emergency delay</i> is used the transfer should occur after a time delay (up to 5 minutes). For immediate transfer press the <i>Bypass Time Delay</i> button.	Bypass Time Delay
6	The transfer switch should transfer back to the Normal position. The <i>Normal Transfer Switch Position</i> light should come on and the <i>Emergency</i> light should go off.	Transfer Switch Position  Normal ● Emergency ○
7	If the <i>retransfer to normal delay</i> is used the retransfer should occur after a time delay (up to 30 minutes). For immediate retransfer press the <i>Bypass Time Delay</i> button.	Bypass Time Delay
8	The <i>unloaded running delay</i> keeps the generator running for 5 minutes (cool-down period). Then the generator should stop and the <i>Emergency Source Accepted</i> light should go off.	Source Accepted  Normal ● Emergency ○

## SECTION 2 SEQUENCE OF OPERATION

### Transfer To Emergency

The sequence for load transfer to emergency source begins automatically when normal source voltage falls below the preset dropout point or when *Transfer Test* button is pressed. An under voltage condition on any phase of the normal source is detected by the sensor.

When the normal source voltage fails or the *Transfer Test* button is pressed, the SE relay de-energizes and relay NR begins its timing cycle (1 or 3 seconds, *momentary normal source outage delay*).

The NR relay is provided with a time delay on dropout to override momentary outages and prevent nuisance starting of the engine-driven generator. If the normal source voltage returns above the sensor dropout setting before the time delay expires, the NR relay timing cycle is reset to zero and relay SE energizes.

If the normal source voltage does not return above the sensor dropout setting before the time delay expires, the NR relay de-energizes and signals the engine-driven generator to start. At the same time, a voltage and frequency sensor begins monitoring the emergency source. The sensor will accept the emergency source only when both voltage and frequency reach preset pickup points. Usually about ten seconds elapse from dropout of the NR relay to acceptance by the sensor. This time span occurs because the engine-driven generator must crank, start, and run up to nominal pickup points. For this reason, if the *Transfer Test* button is pressed it must be held for 15 seconds. If the emergency source is available immediately, the sensor may accept it as soon as NR relay drops out.

When the emergency source is accepted by the sensor, relay ER begins its timing cycle (*transfer to emergency delay*). ER relay is provided with an adjustable (0 to 5 minutes) time delay on pickup to delay transfer of the load to the emergency source. For immediate transfer press *Bypass Time Delay* button.

ER relay energizes, the TS coil is energized, the transfer switch operates, and all switch contacts (mains, controls, auxiliaries) reverse position. The transfer switch is now supplying the load from the emergency source.

The transfer switch will remain in the Emergency position until the normal source is restored. If the *Transfer Test* button is used, the transfer switch will remain on emergency until the *retransfer to normal delay* times out.

Lights show position of transfer switch.

Lights show the sources accepted.

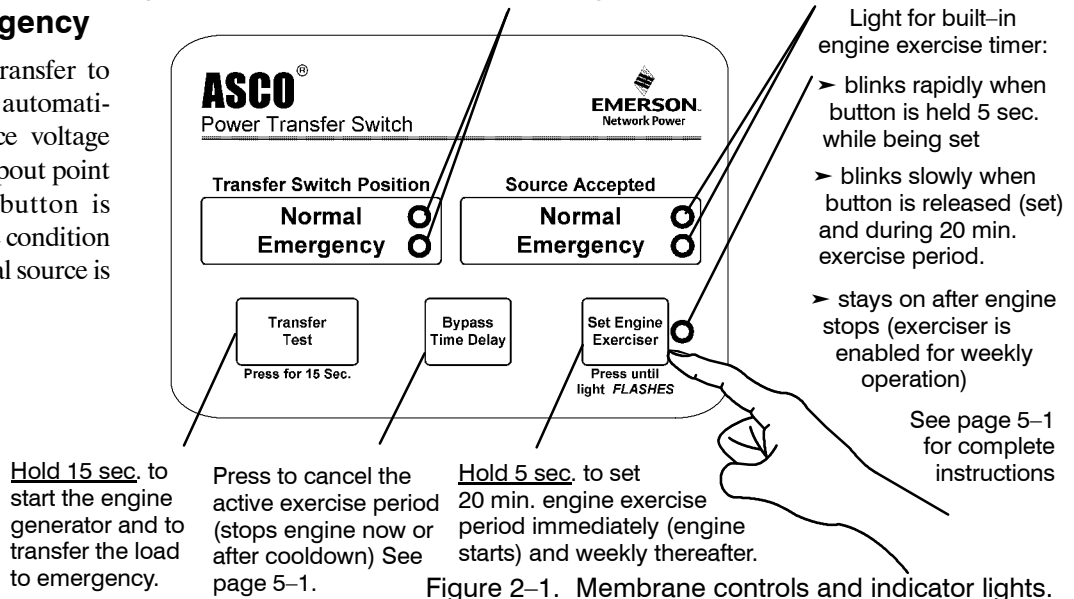

Figure 2-1. Membrane controls and indicator lights.

### Retransfer to Normal

The sequence for load retransfer to the normal source automatically begins when the voltage sensor detects restoration of the normal source. The voltage level must rise above the preset pickup point on all phases before the sensor will accept the normal source.

When the normal source is accepted by the sensor, relay SE begins its timing cycle (adjustable 1 sec. to 30 min., *retransfer to normal delay*). For immediate retransfer press *Bypass Time Delay* button. SE relay is provided with a time delay on pickup to prevent immediate load retransfer to the normal source. The delay insures that the normal source has stabilized before reconnection of vital loads. If the normal source voltage falls below the present dropout point before the time delay expires, the timing cycle is reset to zero. If the emergency source fails for more than 4 seconds during the timing cycle, ER relay drops out and the load is immediately retransferred to the normal source, if that source is acceptable.

SE relay energizes and ER relay is dropped out. The TS coil is energized, the transfer switch operates, and all switch contacts (mains, controls, auxiliaries) reverse position. The transfer switch is now supplying the load from the normal source again.

Upon retransfer to the normal source, NR relay begins its timing cycle (*unloaded running delay [engine cooldown]*). NR relay is provided with a 5 minute time delay on pickup to keep the engine running for a cool-down period.

NR relay energizes after the time delay and signals the engine-driven generator to shut down. All circuits are reset for any future normal source failure.

Activation of standard control features shown in Section 5 will alter the sequence of operation and introduce additional time delays during transfer operations.

## SECTION 3 TESTING & SERVICE

### PREVENTIVE MAINTENANCE

Reasonable care in preventive maintenance will insure high reliability and long life for the automatic transfer switch.

**Operate the switch at least once a month.** Perform this four step Electrical Operation Test. This is a test with load transfer.

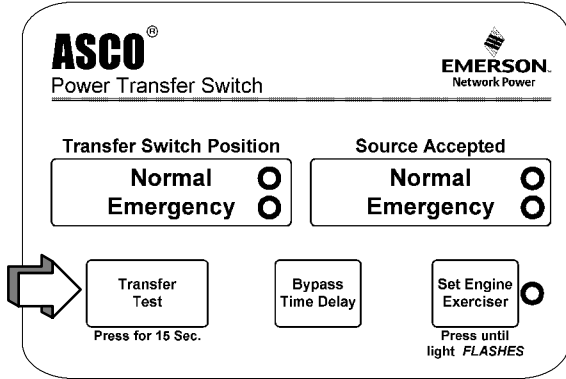

#### Transfer Switch Test

1.	Press and hold the door-mounted <b>Transfer Test</b> button until the engine starts and runs. This should happen within 15 seconds.
2.	The transfer switch will operate to the Emergency position. If the <i>Transfer To Emergency Delay</i> is used, the transfer will occur after a time delay (up to 5 minutes). For immediate transfer press <b>Bypass Time Delay</b> button.
3.	The Transfer Switch will operate back to the Normal position after the <i>Retransfer To Normal Delay</i> (up to 30 minutes). For immediate retransfer press <b>Bypass Time Delay</b> button.
4.	<i>Unloaded Running (Engine Cooldown) Delay</i> allows engine to run unloaded for 5 minutes.

**Clean and inspect the switch once a year.** De-energize all sources, then brush and vacuum away any excessive dust accumulation. Remove the transfer switch barriers and check contact condition. Replace contacts when pitted or worn excessively. Reinstall the barriers carefully.

**Maintain transfer switch lubrication.** The transfer switch has been properly lubricated, and under normal operating conditions no further lubricating is required. Renew factory lubrication if the switch is subjected to severe dust or abnormal operating conditions. Relubricate the operator if TS coil is replaced. Order *lubrication kit 75-100*.

**Replacement parts.** Replacement parts are available in kit form. When ordering parts provide the Serial No. and Catalog No. from the transfer switch nameplate. Contact your local ASCO Power Technologies sales office, representative, or ASI. In the United States call 1-800-800-ASCO (2726), or in Canada call 1-888-234-ASCO (2726).

### DISCONNECTING THE CONTROLLER

The harness disconnect plugs are furnished for repair purposes only and should not have to be unplugged. If the controller must be isolated, follow these steps carefully.

#### Disconnecting the Plugs

**⚠ WARNING**

**Do not unplug the controller until step 1a. or 1b. below is completed.**

1. Observe the position of the transfer switch.
  - a. If the transfer switch is in the *Normal* position, place standby engine starting control in the *off* position. Then open the emergency source circuit breaker.
  - b. If the transfer switch is in the *Emergency* position, open the normal source circuit breaker. Place the engine starting control in the *test* or *run* position.
2. Separate the quick disconnect plugs by squeezing the latches. Do not pull on the harness wires.
3. Label, remove, and tape the signal wires connected to the engine start terminals on the transfer switch: TB1 and TB3, or TB1 and TB2.

#### Reconnecting the Plugs

**⚠ WARNING**

**Do not reconnect the controller until step 1a. or 1b. and 2 below are completed.**

1. Observe the position of the transfer switch.
  - a. If the transfer switch is in the *Normal* position, be sure that the standby engine starting control is still in the *off* position. The emergency source circuit breaker still should be open.
  - b. If the transfer switch is in the *Emergency* position, normal source circuit breaker still should be open.
2. Reconnect the signal wires connected to the appropriate engine start terminals on the transfer switch. See **Section 1, Engine Starting Contacts**.
3. The harness plugs and sockets are keyed. Carefully align the plugs with the sockets and press straight in until both latches click.
4. Restore the opposite source as follows:
  - a. If the transfer switch is in the *Normal* position, place the standby engine starting control in the *automatic* position. Then close the emergency source circuit breaker.
  - b. If the transfer switch is in the *Emergency* position, close the normal source circuit breaker. The load will be automatically retransferred to the normal source after the *Retransfer to Normal Delay*. For immediate retransfer, press **Bypass Time Delay** button. Place the engine starting control in the *automatic* position.

## TESTING & SERVICE *(continued)*

### MANUAL LOAD TRANSFER

This procedure will manually transfer the load if the controller is disconnected.

#### **WARNING**

**Do not manually operate the transfer switch until both power sources are disconnected: open both circuit breakers.**

1. Open normal and emergency source circuit breakers.
2. Use the maintenance handle to manually operate transfer switch to the opposite source. See page 1–3, *Manual Operation Test*.
3. If the transfer switch is in the Emergency position manually start the engine generator and then close the emergency source circuit breaker.

### TROUBLE-SHOOTING

Note the control features that are activated or furnished on the switch and review their operation. Refer to **Section 5, Control Features**.

#### **WARNING**

**Proceed with care!  
The automatic transfer switch is energized.**

Table 3-1. Trouble-Shooting Checks.

PROBLEM	CHECK IN NUMERICAL SEQUENCE		
	1 OPERATION	2 GEN-SET	3 VOLTAGE
Gen-Set does not start when the <b>Transfer Test</b> button is pressed and held for 15 seconds or when the normal source fails.	Hold the <b>Transfer Test</b> button 15 sec. or the outage must be long enough to allow for the 1 or 3 sec. <i>Momentary Normal Source Outage Delay</i> plus engine cranking and starting time.	Starting control must be in automatic position. Batteries must be charged and connected. Check wiring to engine starting contacts.	—
Transfer switch does not transfer the load to emergency source after the gen-set starts.	Wait for <i>Transfer to Emergency Delay</i> (0 to 5 min.) to time out. For immediate transfer, press the <b>Bypass Time Delay</b> button. If Motor Load Transfer is active, wait for inphase condition (see below).	Generator output circuit breaker must be closed. Generator frequency must be at least 57 Hz.	Voltmeter should read at least 90% of nominal phase to phase voltage between transfer switch terminals EA and EC (or EL1 and EL2 for 2 pole switches). * * These are factory settings.
Transfer switch does not transfer the load to normal source when normal returns or when <b>Transfer Test</b> button is released.	Wait for <i>Retransfer to Normal Delay</i> (1 sec. to 30 min.) to time out. For immediate retransfer, press <b>Bypass Time Delay</b> button. If Motor Load Transfer is active, wait for in-phase condition (see below).	—	Voltmeter should read at least 90% of nominal phase to phase voltage between transfer switch terminals NB and NC, NC and NA, and NA and NB (or NL1 and NL2 for 2 pole switches).
Gen-Set does not stop after load retransfer to the normal source.	Wait for the 5 minute <i>Unloaded Running Delay</i> to time out.	Starting control must be in automatic position.	—

#### Trouble-Shooting the Motor Load Transfer Feature (refer to page 5–4)

#### **DANGER**

**Use extreme caution when using a meter to measure voltages in the following steps. Do not touch power terminals; shock, burns, or death could result !**

1. Connect a voltmeter (set for twice system phase-to-phase voltage) between Transfer Switch terminals NA and EA.
2. Manually start generator. Voltmeter needle should sweep back and forth at a regular rate between 0 and about twice system voltage.

3. Press and hold **Transfer Test** button. The load should transfer to emergency source when meter needle is near 0 volts. If transfer does not occur, Motor Load Transfer feature is not operating.
4. Release the **Transfer Test** button. The load should retransfer back to the normal source after the *Retransfer to Normal Delay*, if used. The retransfer should occur when the needle is near 0 volts. If retransfer does not occur after the time delay, the Motor Load Transfer feature is not operating.
5. For immediate retransfer, press the **Bypass Time Delay** button. Then disconnect the voltmeter.

If the problem is isolated to circuits on the controller or the transfer switch, call your local ASCO Power Technologies sales office, representative, or ASI. In United States, call 1–800–800–2726 or email [customer@asco.com](mailto:customer@asco.com). In Canada, call 1–888–234–2726. Furnish the Serial No., Bill of Material (BOM) No., & Catalog No. from transfer switch nameplate.

## SECTION 4 ADJUSTMENTS

### Time Delay Adjustment

Standard time delays are set to customer specifications (if none specified, standard factory settings are used).

To change a setting, follow procedure on page 4-2. Use Table 4-1 as a guide to time delay values and their corresponding adjustment DIP switch or potentiometer.

Table 4-1. Time Delay Settings

DESCRIPTION	LABELS	FACTORY SETTING	ADJUSTMENT RANGE	S3 DIP SWITCH		ADJUSTMENT POTENTIOMETER
Override Momentary Normal Source Outages	TD ES	3 seconds	1 second	Actuator 1 on		—
			3 seconds	Actuator 1 off		
Transfer to Emergency	TIMER N/E	0 minutes (full ccw)	0 to 5 minutes	—	—	P2
Override Momentary Emergency S. Outages	—	4 seconds	non-adjustable	—	—	—
Retransfer to Normal	TIMER E/N	30 minutes (full cw)	1 second to 30 minutes	—	—	P1
Unloaded Running (Engine Cooldown)	—	5 minutes	non-adjustable	—	—	—

### Sensor Adjustments

Voltage and frequency sensor pickup and dropout points are set to customer specifications (if none specified, standard factory settings are used). To change a setting, follow procedure on page 4–2. Use Tables 4-2 and 4–3 for settings and corresponding DIP switch actuators.

**⚠ WARNING**

**Any change in these settings may affect the normal operation of the automatic transfer switch. This change could allow the load circuits to remain connected to a low voltage source.**

Table 4-2. Voltage and Frequency Settings. ( Shaded DIP switches are standard factory settings).

DESCRIPTION	LABELS	SETTING	% of nominal		S1 DIP SWITCH	
			FACT. SET	ADJ RANGE		
Normal Source Voltage	PU / N	Pickup	90 %	95 % *	Actuator 3 off	
				90 %	Actuator 3 on	
	DO / N	Dropout	85 %	90 % *	Actuator 1 off Actuator 2 off	
				85 %	Actuator 1 on Actuator 2 off	
				80 %	Actuator 1 off Actuator 2 on	
				70 %	Actuator 1 on Actuator 2 on	
Emergency Source Voltage	--	Pickup	90 %	non-adjustable	--	
	--	Dropout	75 %	non-adjustable	--	
Emergency Source Frequency	60 / 50 Hz	60 / 50 Hz	60 Hz	60 Hz	Actuator 4 off	
				50 Hz	Actuator 4 on	
Voltage Phases	3, 1	3 / 1	3	3 phase	Actuator 6 off	
				1 phase	Actuator 6 on	

\* If dropout voltage is set to 90%, the pickup voltage must be set to 95%.

Table 4-3. Transformer Voltage Adjust.

(Low setting shifts all voltage settings down 4.2%; for example, 240 V to 230 V, or 480 V to 460 V)

DESCRIPTION	LABELS	FACTORY SETTING	ADJUSTMENT	S3 DIP SWITCH	
Voltage Adjust (4.2%)	LOW / HI	HI	LOW	Actuator 2 off	
			HI	Actuator 2 on	

## ADJUSTMENTS (continued)

### **WARNING**

**Do not make any setting changes while the controller is energized.**

### How to Change a Setting

1. Prevent the transfer switch from operating by disconnecting one source first, then the other, as follows:
  - a. If the transfer switch is in the Normal position, open the emergency source circuit breaker. Turn the engine starting control to *off*. Then open the normal source circuit breaker.
  - b. If the transfer switch is in the Emergency position, open the normal source circuit breaker. Turn engine starting control to *test* or *run*. Then open the emergency source circuit breaker.
2. Disconnect both harness plugs from controller by squeezing the latches. Do not pull on the wires.
3. Remove cover from the controller by releasing latch on right side with your thumb. See Figure 4-1.
4. Locate the appropriate adjustment potentiometer or DIP switch for the setting that you want to change. Refer to Table 4-1 and Table 4-2 on page 4-1 and Figure 4-2, Figure 4-3, Figure 4-4 on page 4-2.
5. Use a small screwdriver to turn the potentiometer clockwise to increase the time delay or counterclockwise to decrease it. See Figure 4-3.
6. Use a ball-point pen (or similar pointed tool) to slide the switch actuators left or right so they match the illustration next to the setting (left = off, right = on). Recheck the setting. See Figure 4-4.
7. Install the cover on the controller by hooking it on the left side and latching the right side.
8. Reconnect both harness plugs to the controller by aligning and pressing straight in until latches click.

### **WARNING**

**Close the enclosure door.**

9. Close the enclosure door, then restore both sources:
  - a. If the transfer switch is in the Normal position first close the normal source circuit breaker, then close the emergency source circuit breaker.
  - b. If the transfer switch is in the Emergency position, close the normal source circuit breaker. The load will be automatically retransferred to the normal source. Then close the emergency source circuit breaker.
10. Turn the engine starting control to *automatic*.

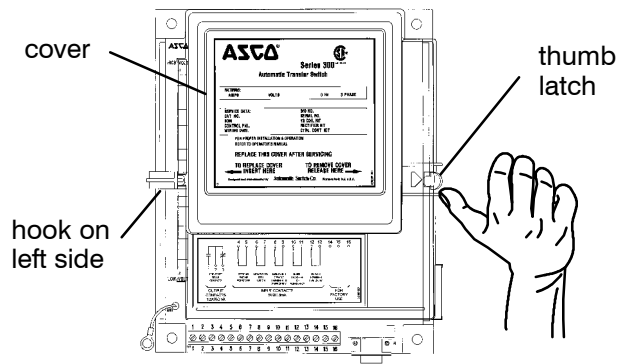

Figure 4-1. Controller cover latch.

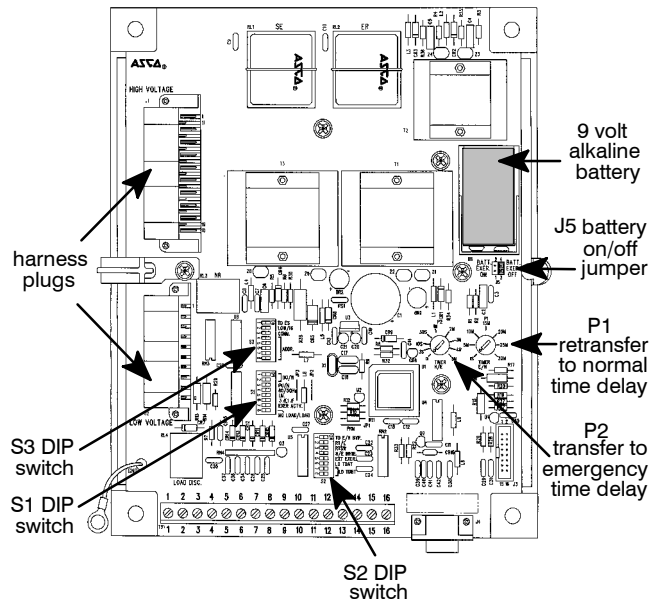

Figure 4-2. Location of potentiometers.

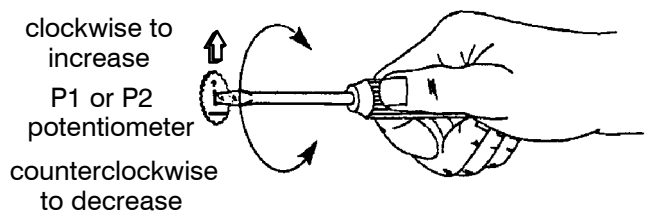

Figure 4-3. Changing time delay potentiometers.

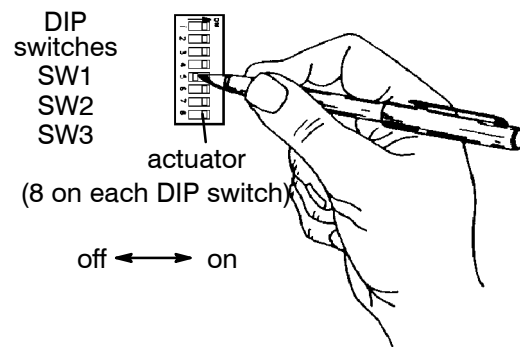

Figure 4-4. Setting DIP switch actuators.

## SECTION 5 CONTROL FEATURES – ENGINE EXERCISERS

These timers periodically exercise the emergency engine-generator plant. They can be set to exercise with or without load transfer, or they can be completely disabled. The engine-generator should be exercised under load once a week for a minimum time period of 20 minutes, or follow the recommendations of the engine-generator set manufacturer. Refer to page 4-2 for location of DIP switches, battery (provided), and jumper block in the controller.

### BUILT-IN ENGINE EXERCISER

The engine exerciser included in ASCO Series 300 Automatic Transfer Switches provides a once a week 20-minute exercise period. It occurs immediately when the **Set Engine Exerciser** push button is pressed (and held for at least 5 seconds), and then at the same time weekly thereafter. A 9 volt alkaline battery (*Duracell* MN1604, *Everready* 522, or *Panasonic* 6AM6) is furnished and installed in the controller to maintain the setting. The battery jumper block must be shifted to the ON position. See Figure 4-2 on page 4-2.

Fill in day and time set. Week Day \_\_\_\_\_ Time \_\_\_\_\_.

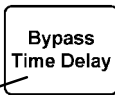





Press to cancel an active exercise period (stops generator). 

If *Exercise with Load* is set, retransfers load to Normal, then stops generator after min. cooldown.

 status light  
Press and hold for 5 sec. or until status light blinks rapidly to set exercise period immediately and every week hereafter (generator starts).

If *Exerciser with Load* is set, transfers load to Emergency.

### DIP Switch Settings

FUNCTION	S1 DIP SWITCH	S2 DIP SWITCH
Std. Timer Enabled	Actuator 7 on 	Actuator 5 on 
Std. Timer Disabled	Actuator 7 off 	Actuator 5 on 
Exercise without Load	Actuator 8 off 	
Exercise with Load	Actuator 8 on 	





 Shaded DIP switches are standard factory settings.





Figure 5-1. Operator panel pushbuttons and light.

Select below either *Exercise without Load* or *Exercise with Load* according to the setting of DIP switch S1, actuator 8. The load transfers from the Normal source to Emergency source (generator) and back again if *Exercise with Load* is selected.

#### Exercise without Load, DIP Switch S1, Actuator 8 off How to Set Built-In Timer

Step	Push Button	Status Light	Function	Explanation
1	 <b>Set Engine Exerciser</b> <u>hold</u> 5 sec.	blinks rapidly 	set exercise period	Exercise the generator <u>now</u> and every week at this time hereafter.
2	release	blinks slowly 	exercise period now active	Generator starts and runs.
3	press <b>Bypass Time Delay</b>	● stays on	cancel active exercise period	Generator stops.
4	—	● stays on	generator off	Exerciser enabled; repeats every 7 days.

#### Exercise with Load, DIP Switch S1, Actuator 8 on How to Set Built-In Timer

Step	Push Button	Status Light	Function	Explanation
1	 <b>Set Engine Exerciser</b> <u>hold</u> 5 sec.	blinks rapidly 	set exercise period	Exercise the generator <u>now</u> and every week at this time hereafter.
2	release	blinks slowly 	exercise period now active	Generator starts and runs; the load transfers to Emergency.
3	press <b>Bypass Time Delay</b>	blinks slowly 	cancel active exercise period	The load retransfers to Normal; then generator runs for 5 minute cooldown ( light blinks slowly during cooldown ).
4	—	● stays on	generator off	Exerciser enabled; repeats every 7 days.

**NOTE:** Every time *SET ENGINE EXERCISER* push button is pressed (held 5 seconds) the exercise period is changed.

## CONTROL FEATURES *(continued)*

### Optional Accessory 11BG – SOURCE AVAILABILITY SIGNAL & PROGRAMMABLE ENGINE EXERCISER MODULE

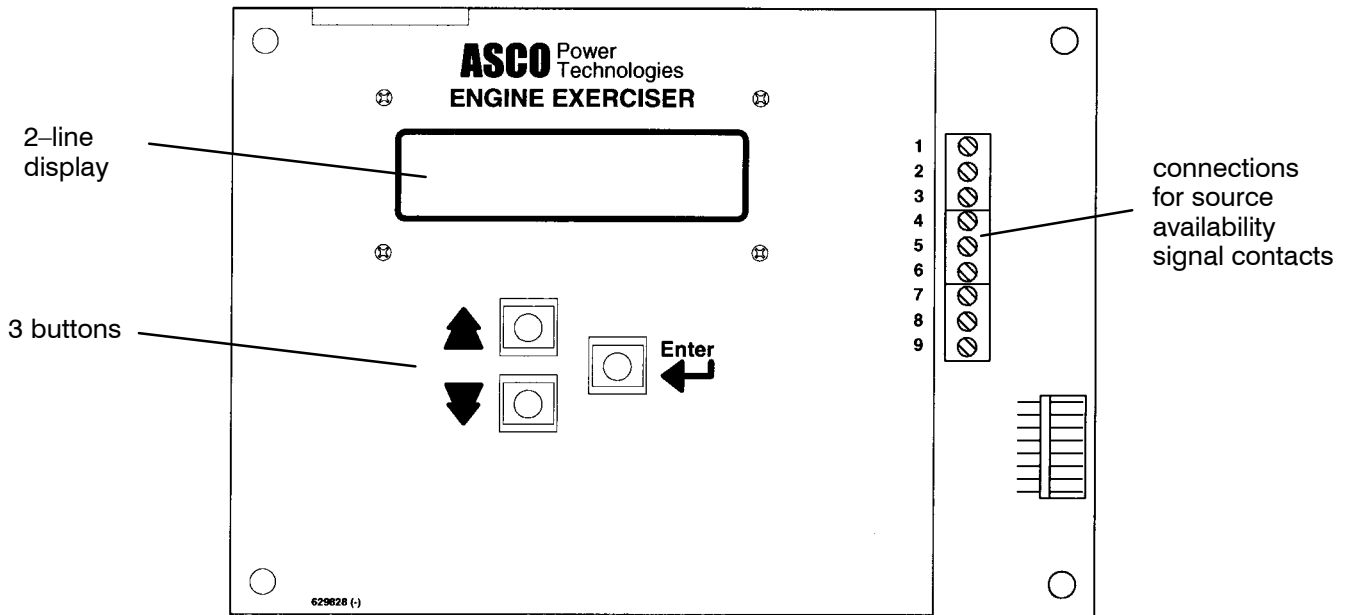

Figure 5-2. Accessory 11BG module (mounted behind operator interface and connected to the controller) includes source availability signal contacts and a programmable engine exerciser.

#### Source Availability Signal Contacts

The module provides one Form C contact each for the normal and emergency sources signal the acceptability of the source as sensed by the controller. The signal contacts operate in conjunction with the *Source Accepted* lights on the operator interface. Field wiring terminals are provided as shown in Figure 5-3 and the wiring diagram.

Contact ratings:

2 amps @ 30 Vdc, 0.5 amp. @ 125 Vac resistive

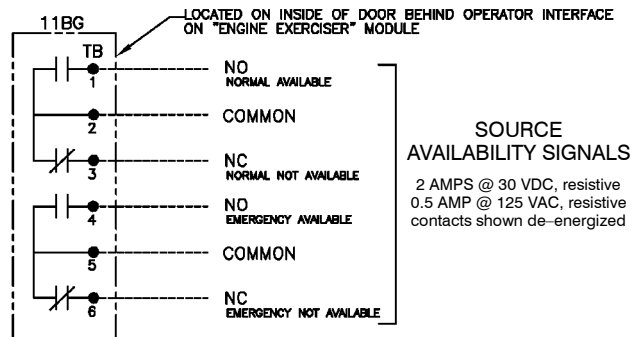

Figure 5-3. Source availability signal contacts.

#### Programmable Engine Exerciser

The module includes a programmable engine exerciser that provides for weekly or biweekly operation. This optional exercise timer may have to be turned on (enabled) by setting the S1 DIP switch actuator 7 to off, and S2 DIP switch actuator 5 to off. A backup battery in the controller (see page 4-2 and page 5-3) must be turned on to maintain the settings and to allow programming with the normal and emergency power turned off (page 5-1).

The programmable engine exerciser incorporates a 7 day or 14 day time base. Proper controller settings must be made to determine whether or not the test will be done with or without load transfer (S1 DIP switch actuator 8).

See next page for instructions on setting the timer.

#### DIP Switch Settings in the Controller

(see page 4-2)

FUNCTION	S1 DIP SWITCH	S2 DIP SWITCH
Opt. Timer Enabled	Actuator 7 off 	Actuator 5 off 
Opt. Timer Disabled	Actuator 7 off 	Actuator 5 on 
Exercise without Load	Actuator 8 off 	
Exercise with Load	Actuator 8 on 	

Shaded DIP switches are standard factory settings.

## CONTROL FEATURES *(continued)*

### How to Set Optional Programmable Engine Exerciser (part of Acc. 11BG module)

#### ⚠ DANGER

**Hazardous voltage capable of causing shock, burns, or death is used in this transfer switch. Deenergize both Normal & Emergency power sources before programming the exerciser.**

#### Navigating the Menu

Use the UP and DOWN arrow keys to move through the displays.

#### Changing the Parameters

Use the UP and DOWN arrow keys to move through the displays to the parameter to be changed. Push the ENTER key to start the editing process. The first parameter will flash. Use the UP and DOWN arrow keys to adjust the parameter to the desired value and press the ENTER key to save the value. The next parameter will now flash. Repeat the process until each parameter is properly configured.

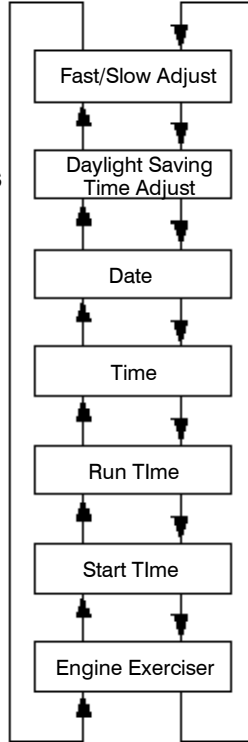

#### Engine Exerciser Display

The Engine Exerciser Display shows the status of the engine exerciser. When the unit is shipped from the factory the programmable engine exerciser is “Disabled” and must be set to “Enabled” by the customer. When the engine exerciser is running, this display will count down the remaining time until the end of the exercise period.

#### Start Time Display

The Start Time Display shows the engine exerciser start time. There are four parameters that determine the start time:

- weekly (“Every”) or bi-weekly (“Alt”) operation
- day of week (“Sun” through “Sat”)
- start hour (0 through 23)
- start minutes (0 through 59)

For example, if the user wants the exerciser to run every other Saturday at 3 PM, the proper configuration would be: “Alt Sat @ 15:00”

#### Fill in your settings for future reference

Weekly or Bi-weekly	Day of Week	Start Time	Run Time
<i>Every</i> = weekly <i>Alt</i> = bi-weekly	<i>Sun</i> through <i>Sat</i>	0 – 23 hour 0 – 59 minute	0 – 23 hour 0 – 59 minute 30 min. is default setting

Date exerciser was set \_\_\_\_\_

NOTE: When choosing bi-weekly operation, the exerciser will always run on the week designated “(1)” on the date display.

#### Run Time Display

The Run Time Display shows the run time for the engine exerciser. The default setting from the factory is 30 min.

#### Time Display

The Time Display shows the present system time. The format is “hours:minutes:seconds”.

NOTE: During total power outages, power to the accessory is maintained by a battery in the Controller (see page 4–2). Be sure that the 9-volt alkaline battery is fresh and enabled (jumper in ON position) so that the time and date settings are not lost.

#### Date Display

The Date Display shows the present system date. The format is “day of week (week) month/day of month/year”.

NOTE: Week is either week 1 or week 2. This is used in conjunction with the bi-weekly timer.

#### Daylight Savings Time Adjust Display

This display shows whether the automatic daylight saving time adjustment is active. The factory default is “NO”. If enabled, the unit will automatically adjust for daylight saving time at 2 AM on Sunday as follows:

Part No.	629857–001*	629857–002*
Start	first Sunday in April	2nd Sunday in March
Stop	last Sunday in Oct	first Sunday in Nov

\* Part no. on back of circuit board. New DST starts in 2007.

#### Fast / Slow Adjust Display

This display shows the automatic fast/slow adjustment value. The factory default is 0. This feature can be used to trim a clock that runs fast or slow. For example, if your clock runs 10 seconds slow per week, change the fast/slow adjust value to “+10” and the unit will automatically add 10 seconds to the clock every week.



NOTE: Adjustments are made Sunday morning at 2 AM. If you want your exerciser period to start at 2 AM on Sunday, you cannot use this feature and the adjustment must be set to 0.

## CONTROL FEATURES *(continued)*

### INPHASE MONITOR FOR MOTOR LOAD TRANSFER

Inphase monitoring logic controls transfer and retransfer of motor loads, so that inrush currents do not exceed normal starting currents. It avoids nuisance tripping of circuit breakers and mechanical damage to motor couplings.

The Motor Load Transfer feature is built into the controller. DIP switch S1 (actuator 5) activates this feature: right = ON, left = OFF.

FUNCTION	S1 DIP SWITCH	
enable	Actuator 5 on	
disable	Actuator 5 off	

 Shaded DIP switches are standard factory settings.

#### Note

If the Motor Load Transfer feature is enabled, it will be activated following the Load Disconnect Feature Delay Before Transfer delay.



### LOAD DISCONNECT FEATURE

Connect external circuits to the terminals indicated on the Wiring Diagram provided with the ATS.

The double throw (Form C) contact is rated for 28 VDC or 120 VAC (5 amps resistive). The contact operates prior to a selectable 0, 3, 10, or 20 second delay before transfer of the Automatic Transfer Switch. The contact resets either immediately following transfer or after the same delay as set for pre-signal before transfer.

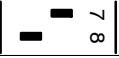

Time delay between the load disconnect control signal and initiation of transfer is set on the controller with DIP switch S2 (actuators 6, 7, 8) as shown below:

#### Delay Before Transfer

LD TDBT	S2 DIP SWITCH	
0 (disable)	Actuator 7 on Actuator 8 on	
3 seconds	Actuator 7 on Actuator 8 off	
10 seconds	Actuator 7 off Actuator 8 on	
20 seconds	Actuator 7 off Actuator 8 off	

 Shaded DIP switches are standard factory settings.

#### Delay After Transfer\*



LD DAT	S2 DIP SWITCH	
enable	Actuator 6 on	
disable	Actuator 6 off	

\*Enabling the Delay After Transfer will cause the control signal to reset after the same delay as set for the Delay Before Transfer.

## REMOTE CONTROL FEATURES

These remote control features require a customer-supplied normally closed contact suitable for a 5 V dc low energy circuit. Refer to the Wiring Diagram provided with the ATS. Activate appropriate DIP switch S2 actuators below.

### Remote Test (terminals CP6–7)

RTSW	S2 DIP SWITCH	
disable	Actuator 3 on	
enable	Actuator 3 off	

### Remote Transfer to Emergency (CP8–9)

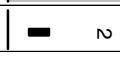
RT /E	S2 DIP SWITCH	
disable	Actuator 2 on	
enable	Actuator 2 off	

### Bypass Transfer Time Delay (CP12–13)

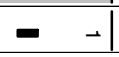
TD E/N BYP.	S2 DIP SWITCH	
disable	Actuator 1 on	
enable	Actuator 1 off	

### Inhibit Transfer to Emergency (CP10–11)

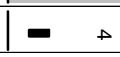
N/E INHIB.	S2 DIP SWITCH	
disable	Actuator 4 on	
enable	Actuator 4 off	

## CONTROL FEATURES *(continued)*

### OPTIONAL STRIP HEATER (Accessory 44)

Accessory 44 Strip Heater is designed to keep ambient temperatures within the Automatic Transfer Switch enclosure at acceptable levels. This accessory consists of a mounting bracket with strip heater, thermostat, and terminal block. A transformer with fuses is included when the power for the assembly is derived from voltages above 120 V ac. The 120 V ac customer powered assembly does not include a transformer. This optional accessory is available factory installed or in kit form.

Turn the thermostat's dial to required setting as shown.

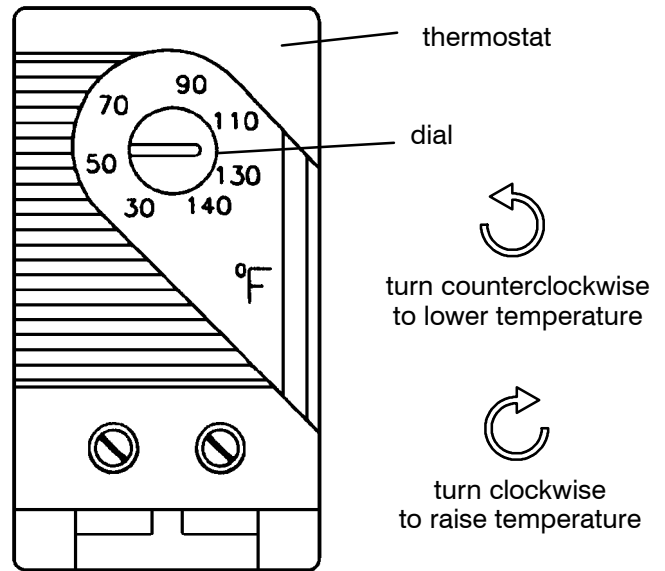

Figure 5-4. Thermostat.

## AVAILABLE KITS FROM ASCO

### Controls

Description	Accessory	Kit
Programmable Engine Exerciser & Source Availability Contacts	11BG	K629830
Serial Communication Module	72A	K601110

### Strip Heater – Accessory 44

Description	Accessory	Kit
120 volt customer supplied voltage (without transformer)	44A	K613127-001
208 – 480 volt ATS derived voltage (with transformer)	44G	K613127-002
380 volt ATS derived voltage (with transformer)	44G	K613127
550 – 600 volt ATS derived voltage (with transformer)	44G	K613127-003

# INDEX

## A

accessories, 5-2, 5-5  
auxiliary circuits, 1-2

## B

battery, 4-2, 5-1  
buttons, push, 3-1  
bypass time delay, 1-5, 2-1, 3-1

## C

cable  
  lugs, 1-1  
  preparation, 1-1  
catalog number, inside cover  
cleaning, 3-1  
connections  
  engine control contact, 1-2  
  line, 1-1  
contact position indicators, 1-3  
contacts  
  auxiliary, 1-2  
  engine control, 1-2  
  main, 1-3, 3-1  
  source availability signal, 5-2  
control features, 5-1  
  load disconnect, 5-4  
  motor load transfer, 5-4  
  plant exerciser, 5-1, 5-2, 5-3  
controller, 4-1, 4-2  
  codes, cover  
  cover removal, 4-2  
  disconnecting, 3-1  
  time delay potentiometers, 4-2

## D

DIP Switches, 4-1, 4-2, 5-1, 5-2, 5-4

## E

electrical operation, 1-5  
engine exerciser, 5-1, 5-2, 5-3  
engine starting contacts, 1-2

## F

features, *see* control features  
frequency, pickup and dropout  
  settings, 4-1  
functional test, 1-3, 1-4, 1-5

## G

ground, controller, 1-1

## H

handle, maintenance, 1-3  
  warning, 1-3  
harness, 1-2  
  disconnect plugs, 3-1

## HELP

800-800-2726 (ASCO)  
customer@asco.com

## I

inphase monitor, 5-4  
inspection, 3-1  
installation, 1-1

## L

labels,  
  engine starting contacts, 1-2  
  inputs / outputs, 1-2  
  rating, cover  
lights, 1-4, 5-1  
load disconnect feature, 5-4  
lubrication, 3-1

## M

maintenance, preventive, 3-1  
manual load transfer, 3-2  
  warning, 3-2  
manual operation, 1-3  
  warning, 1-3  
motor load transfer feature, 5-4

## N

nameplate, cover

## O

operation  
  electrical, 1-5  
  manual, 1-3  
  illustration of, 1-3  
  warning, 1-3  
  sequence of, 2-1  
optional accessories  
  programmable engine exerciser  
  & source availability signal  
  contacts, 5-2, 5-3  
  serial communication module, 5-5

strip heater, 5-5

## P

parts, 3-1  
problem, 3-2  
programmable engine exerciser, 5-2,  
  5-3

## R

rating label, cover  
remote control features, 5-4  
  bypass transfer time delay, 5-4  
  inhibit transfer to emergency, 5-4  
  remote test, 5-4  
  remote transfer to emergency, 5-4  
replacement parts, 3-1

## S

service, call 800-800-2726 (ASCO)  
set engine exerciser, 5-1, 5-2, 5-3  
settings  
  changing, 4-1  
  factory, 4-1  
  frequency, 4-1  
  phase, 4-1  
  time delay, 4-1  
  voltage, 4-1  
source accepted lights, 1-4, 1-5

## T

terminal block, 1-2  
test, functional, 1-3, 1-4, 1-5  
time delay  
  adjustment, 4-1  
  gen-set cooldown, 4-1  
  how to change, 4-2  
  override momentary outages, 4-1  
  transfer to emergency, 4-1  
  transfer to normal, 4-1  
timer (plant exerciser), how to set,  
  5-1, 5-2, 5-3  
transfer switch position lights, 1-4,  
  1-5  
transfer test, 1-5, 3-1  
trouble-shooting, 3-2

## V

voltage, phase, 4-1  
voltage, pickup and dropout settings,  
  4-1