

Operator's Manual

ASCO® 7000 Series ATS Automatic Transfer Switches H-design 600 through 1200 amps

TABLE OF CONTENTS

	section-page
INSTALLATION	1-1
Mounting and Line Connections	1-1
Auxiliary Circuits and Harness	1-2
Engine Starting Contacts	1-2
Functional Test	1-2, 1-3, 1-4, 1-5
TESTING & SERVICE	2-1
Transfer Test	2-1
Preventive Maintenance	2-1
Disconnecting the Controller	2-1
Manual Load Transfer	2-2
Trouble-Shooting	2-2
INDEX	back cover

Note: Refer to the outline and wiring drawings provided with your 7000 Series ATS for all installation and connection details and accessories.

An experienced licensed electrician must install the ATS.



600–1000 amp. size



1200 amp. size

⚠ DANGER

DANGER is used in this manual to warn of high voltages capable of causing shock, burns, or death.

⚠ WARNING

WARNING is used in this manual to warn of possible personal injury.

⚠ CAUTION

CAUTION is used in this manual to warn of possible equipment damage.

Refer to *Group 5 Controller User's Guide* 381333–126 for ATS status display messages, time delays, pickup & dropout settings, and adjustments.

Rating Label

Each Automatic Transfer Switch contains a rating label to define the loads and fault circuit withstand/closing ratings. Refer to the label on the Transfer Switch for specific values.

⚠ WARNING

Do not exceed the values on the rating label. Exceeding the rating can cause personal injury or serious equipment damage.

Nameplate

The Transfer Switch nameplate includes data for each specific 7000 Series ATS. Use the switch only within the limits shown on this nameplate. A typical Catalog Number is shown below with its elements explained.

Catalog Number Identification

Typical 7000 Series ATS catalog no. for overlapping neutral, 3 pole, 600 amp, 480 V, ATS in Type 1 enclosure:

H7ATS		C	3	600	N	5	C				
Neutral		Phase Poles		Amperes		Voltage		Controller		Enclosure	
A – solid		2 – single Ø		600		C 208 K 415		5 – standard		C – type 1	
B – switched		3 – three Ø		800		D 220 L 440		5X – if accessories ordered		F – type 3R	
C – overlapping				1000		E 230 M 460				G – type 4 *	
blank – none				1200		F 240 N 480				L – type 12 *	
						G 277 P 550				blank – open type	
						H 380 Q 575					
						J 400 R 600					

* available 600–1000 amp. sizes only

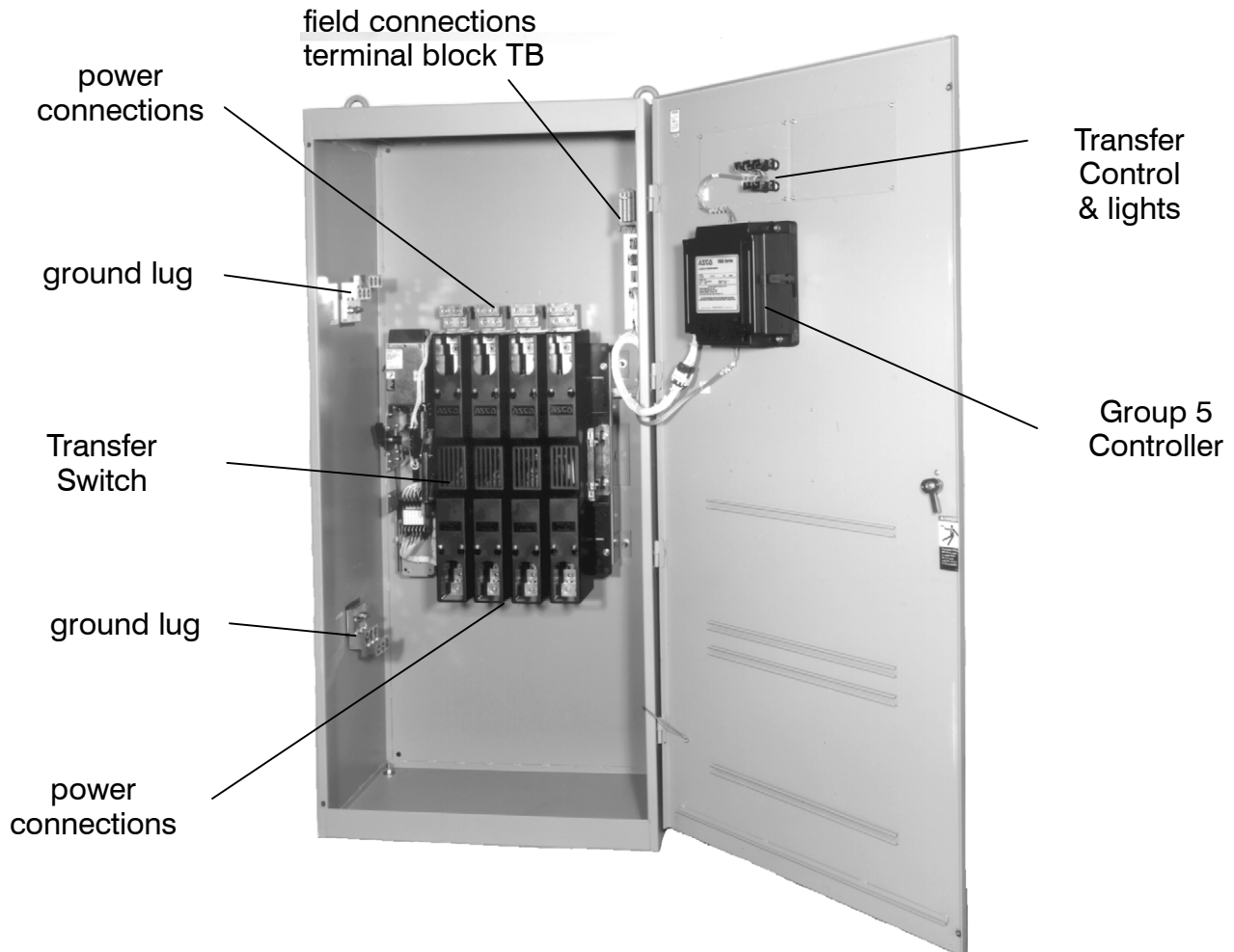

600–1000 amp. size in typical enclosure with location of customer connections

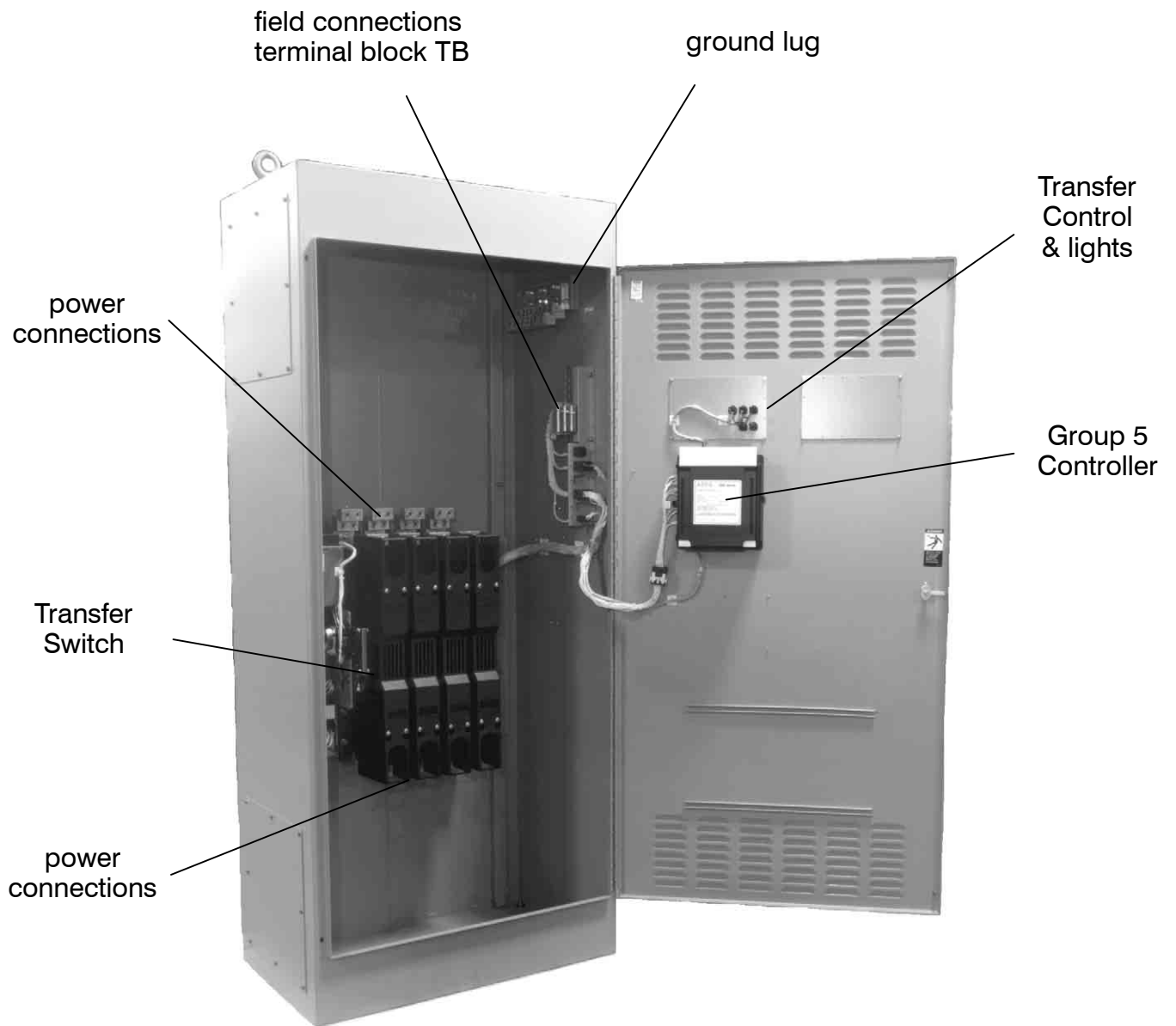

1200 amp. size in typical enclosure with location of customer connections

SECTION 1 INSTALLATION

ASCO 7000 Series Automatic Transfer Switches (ATSS) are factory wired and tested. Field installation requires mounting and connection of service cables, and auxiliary control circuits (if required).

Remove the Shipping Skid (large ATSS)

For large ATSS, open the front door and remove the four lag screws (2 in front, 2 in rear) securing enclosure to the wood skid.

Supporting Foundation

The supporting foundation for the enclosure must be level and straight. Refer to the applicable enclosure outline drawing included with the switch for all mounting details including door opening space.

If bottom cable entry is used, the foundation must be prepared so that the conduit stubs are located correctly. Refer to the enclosure outline drawing for specified area and location. Provide cable bending space and clearance to live metal parts. When a concrete floor is poured, use interlocking conduit spacer caps or a wood or metal template to maintain proper conduit alignment.

Mounting

Refer to the applicable enclosure outline drawing furnished with this switch and mount the automatic transfer switch according to details and instructions shown on diagram.

Line Connections

Refer to the Wiring Diagram provided with the switch. All wiring must be made in accordance with the National Electrical Code and local codes.

It is not necessary to remove pole covers from the transfer switch for cabling. If you do remove them, reinstall them carefully.

DANGER

De-energize the conductors before making any line or auxiliary circuitry connections. Be sure that Normal and Emergency line connections are in proper phase rotation. Place engine generator starting control in the OFF position. Make sure engine generator is not in operation.

Testing Power Conductors

Do not connect the power conductors to the transfer switch until they are tested. Installing power cables in conduit, cable troughs and ceiling-suspended hangers often requires considerable force. The pulling of cables can damage insulation and stretch or break the conductor's strands. For this reason, after the cables are pulled into position, and before they are connected, they should be tested to verify that they are not defective or have been damaged during installation.

CAUTION

Protect the switch from construction grit and metal chips to prevent malfunction or shortened life of the automatic switch switch.

Connecting Power Conductors

After the power cables have been tested, connect them to the appropriate terminal lugs on the transfer switch as shown on the wiring diagram provided with the switch. Make sure the lugs provided are suitable for use with the cables being installed. Standard terminal lugs are solderless screw type and will accept the wire sizes listed on the drawings provided with the switch. Be careful when stripping insulation from the cables; avoid nicking or ringing the conductor. Remove surface oxides from cables by cleaning with a wire brush. When aluminum cable is used, apply joint compound to conductors. Tighten cable lugs to the torque specified on rating label.

Controller Ground

A grounding wire must be connected to the controller's lower left mounting stud. Because the controller is mounted on the enclosure door, a conductive strap must be used between the enclosure and the door. This connection provides proper grounding which does not rely upon the door hinges.

Harnesses

The transfer switch is connected to the left side of the controller by a plug-in harness (two plugs).

INSTALLATION (continued)

Engine Starting Contacts

All customer connections, including the engine control contact connections, are located on terminal block TB which is mounted on the top right side of the enclosure. Refer to the wiring diagram provided with the automatic transfer switch and connect the engine start wires to the appropriate terminals. See Figure 1-1 and Table A.

Table A. Engine start connections.

When normal source fails	Terminals on Terminal Block TB
contact closes	TB1 and TB2
contact opens	TB1 and TB3

Note: To temporarily disable engine control from the automatic transfer switch you can unplug J3 from the small P3 receptacle at the bottom of the assembly. Be sure to reconnect plug J3 to the P3 receptacle for automatic transfer switch operation.

Auxiliary Circuits

Connect auxiliary circuit wires to appropriate terminals on transfer switch terminal block TB as shown on the wiring diagram provided with this automatic transfer switch.

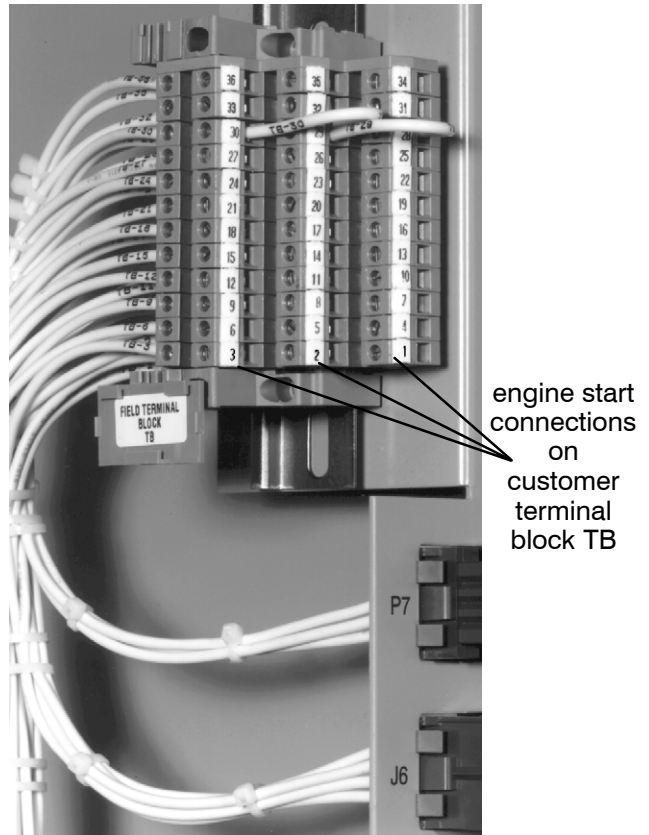

Figure 1-1. Customer terminal block on the top right side of the enclosure.

Functional Test

The Functional Test consists of three checks:

- 1 — Manual Operation Test, page 1-3
- 2 — Voltage Checks, page 1-4
- 3 — Electrical Operation, page 1-5

Read all instructions on the Wiring Diagram and labels affixed to the automatic transfer switch. Note the control features that are provided and review their operation before proceeding.

Continue to **1 – Manual Operation Test** on next page.

CAUTION

Do these checks in the order presented to avoid damaging the ATS.

INSTALLATION *(continued)*

1 – Manual Operation Test



A detachable maintenance handle is provided on the frame of the Transfer Switch for maintenance purposes only. Manual operation of the transfer switch should be checked before it is energized (operated electrically).

⚠ WARNING

Do not manually operate the transfer switch until both power sources are disconnected: open both circuit breakers.

1. After deenergizing both power sources, open the enclosure door. Locate and remove the maintenance handle from the clips on the left side of the transfer switch frame. Insert the handle into the hole in the molded hub on the left side of the operator. See Figures 1-3 and 1-4 and Table B.
2. Move the maintenance handle up or down as shown to manually operate the transfer switch. It should operate smoothly without any binding. If it does not, check for shipping damage or construction debris.
3. Return the transfer switch to the Normal position. Observe that the window indicators (right side) show the top shaft O (open) and the bottom shaft C (closed).

Table B. Maintenance handle positions.

ATS Position	Handle	Indicators
Normal	up 	E = O upper contacts open N = C lower contacts closed
Emergency	down 	E = C upper contacts closed N = O lower contacts open

Note: If Normal and Emergency connections are reversed this operation is also reversed.

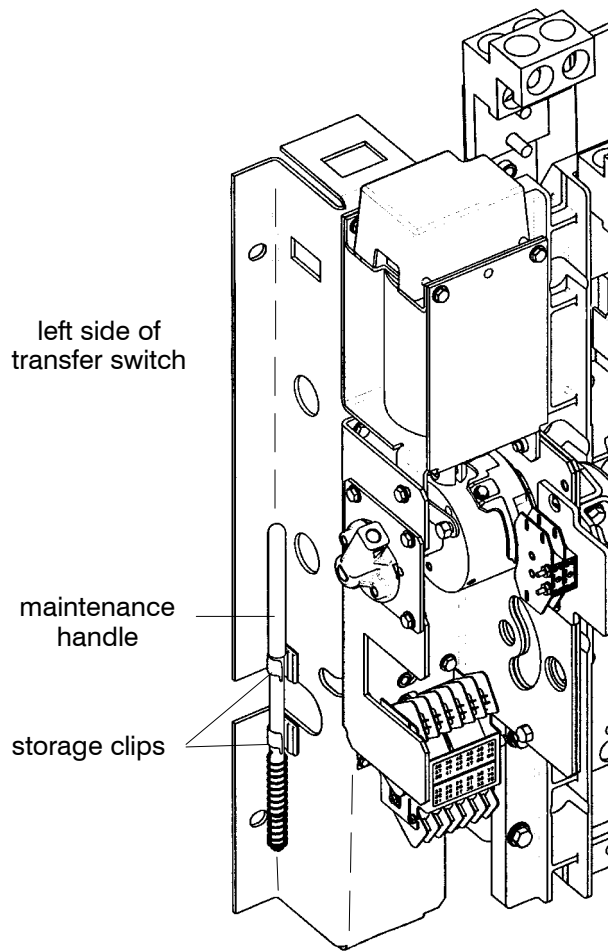
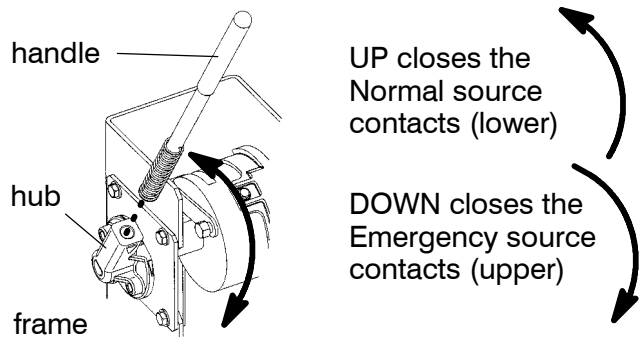

Figure 1-2. Maintenance handle and its storage clips.

4. Remove the maintenance handle and store it on the frame (left side) in the clips provided.

⚠ WARNING

Verify that the maintenance handle has been removed before proceeding!

Now continue to 2 – Voltage Checks on next page.

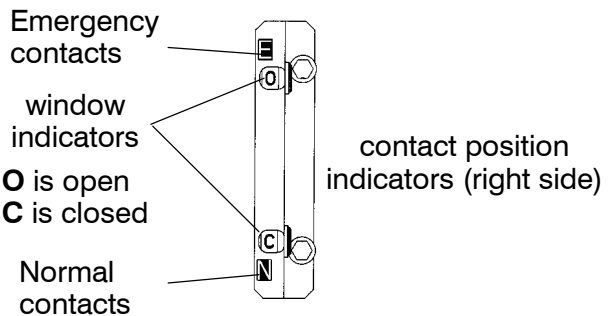

Figure 1-3. Maintenance handle operation and contact position indicators.

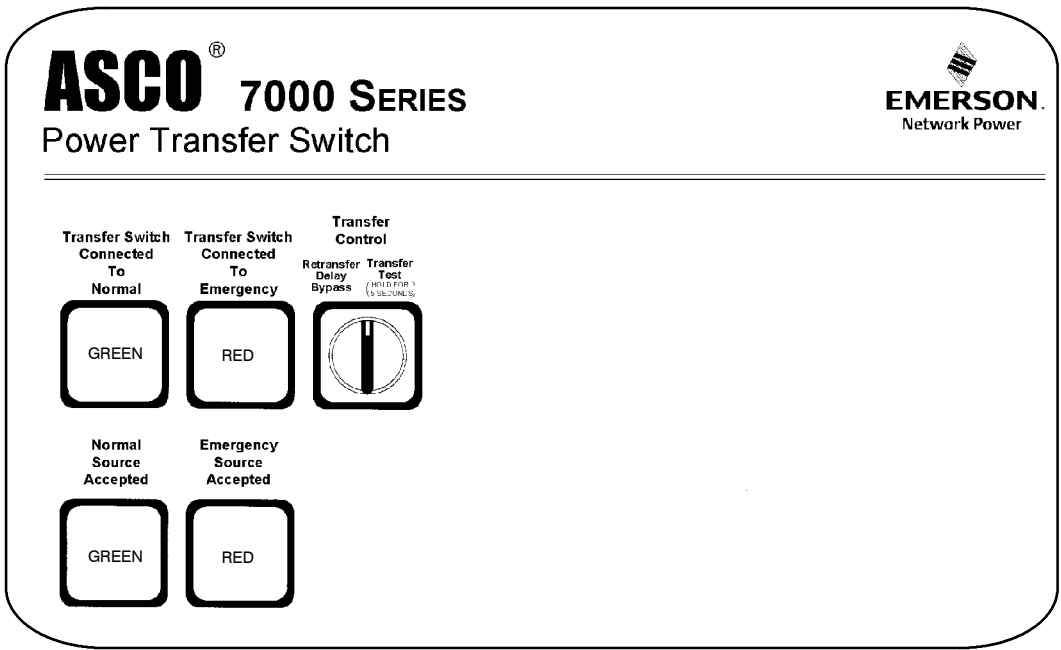

Figure 1-4. Standard controls and indicators.

2 – Voltage Checks

First check nameplate on transfer switch; rated voltage must be the same as normal and emergency line voltages.

⚠ CAUTION

Verify that the feeders have been connected to the proper lugs.

⚠ DANGER

Use extreme caution when using a meter to measure voltages. Do not touch power terminals; shock, burns, or death could result !

Perform steps 1 through 6 at the right. Observe the status lights. See Figure 1-4.

- Black square means light is on.
- White square means light is off.

* If necessary, adjust voltage regulator on the generator according to the manufacturer's recommendations. The Automatic Transfer Switch will respond only to the rated voltage specified on the Transfer Switch nameplate.

Note

Refer to Section 3 of *Group 5 Controller User's Guide* 381333-126 for how to display the Status of the ATS and the Voltage and Frequency of each source.

Now continue to **3 – Electrical Operation** on next page.

1	Close the normal source circuit breaker. The <i>Transfer Switch Connected To Normal</i> and the <i>Normal Source Accepted</i> lights should come on.	
2	Use an accurate voltmeter to check phase to phase and phase to neutral voltages present at the transfer switch normal source terminals.	
3	Close the emergency source circuit breaker. (Start generator, if necessary.) The <i>Transfer Switch Connected To Normal</i> & <i>Emergency Source Accepted</i> lights should come on.	
4	Use an accurate voltmeter to check phase to phase and phase to neutral voltages present at the transfer switch emergency source terminals.*	
5	Use a phase rotation meter to check phase rotation of emergency source; it must be the <u>same</u> as the normal source.	
6	Shut down the engine-generator, if applicable. The <i>Emergency Source Accepted</i> light should go off. Then put the starting control selector switch (on the generator set) in the <i>automatic</i> position. Close enclosure door.	

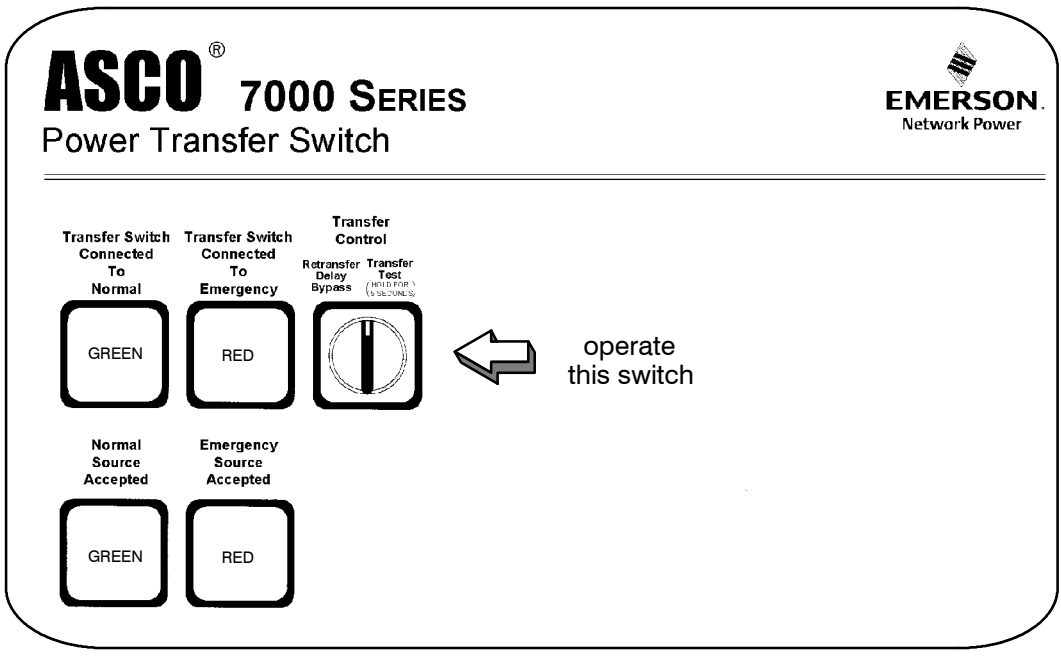

Figure 1-5. Standard controls and indicators.

3 – Electrical Operation

This procedure will check the electrical operation of the Automatic Transfer Switch. See Figure 1-5.

⚠ WARNING

Be sure to close the enclosure door before proceeding to prevent personal injury in case of electrical system fault.

Transfer Test

Both normal and emergency sources must be available and the emergency source generator (if used) must be capable of being started in this procedure.

Perform steps 1 through 5 at the right. Observe the status lights.

- Black square means light is on.
- White square means light is off.

This completes the Functional Test of the ATS.

1	The <i>Transfer Switch Connected To Normal</i> and <i>Normal Source Accepted</i> lights should be on.	
2	Turn and <u>hold</u> Transfer Control switch clockwise to <i>Transfer Test</i> until the engine starts and runs (within 15 sec.). <i>Emergency Source Accepted</i> light should come on.	
3	Transfer switch will operate to the Emergency position after Feature 2B time delay. The <i>Transfer Switch Connected To Emergency</i> light should come on and <i>Load Connected to Normal</i> light goes off.	
4	Transfer switch will operate back to Normal position after Feature 3A time delay. For immediate retransfer turn Transfer Control counterclockwise to <i>Retransfer Delay Bypass</i> . The <i>Transfer Switch Connected To Normal</i> light should come on; <i>Transfer Switch Connected to Emergency</i> light should go off.	
5	The engine-generator will stop after the Feature 2E time delay (unloaded running engine cool-down). The <i>Emergency Source Accepted</i> light should go off.	

SECTION 2 TESTING & SERVICE

TRANSFER TEST

Operate the 7000 Series ATS at least once a month by following the five-step **Electrical Operation Transfer Test** procedure on page 1-5.

PREVENTIVE MAINTENANCE

Reasonable care in preventive maintenance will insure high reliability and long life for the 7000 Series ATS. An annual preventive maintenance program is recommended.

In the United States, ASCO Services, Inc. (ASI) is ASCO Power Technologies's national service organization. ASI can be contacted at 1-800-800-2726 (ASCO) for information on preventive maintenance agreements.

In Canada, for service call 1-800-234-2726 (ASCO).

Checklist for Yearly Inspection

DANGER

Hazardous voltage capable of causing shock, burns, or death is used in this switch. Deenergize both Normal – Emergency power sources before performing inspections!

- Clean the ATS enclosure.** Brush and vacuum away any excessive dust accumulation. Remove any moisture with a clean cloth.
- Check the transfer switch contacts.** Remove the transfer switch barriers and check contact condition. Replace the contacts if they become pitted or worn excessively. Reinstall the barriers carefully.
- Maintain transfer switch lubrication.** If the transfer switch is subjected to severe dust or abnormal operating conditions, renew factory lubrication on all movements and linkages. Relubricate the solenoid operator if the TS coil is replaced. Do not use oil; order *lubrication kit 75-100*.
- Check all cable connections & retighten them.**

REPLACEMENT PARTS

Replacement parts are available in kit form. When ordering parts provide the Serial No., Bill of Material No. (BOM), and Catalog No. from the transfer switch nameplate. Contact your local ASCO Power Technologies Sales Office or ASI:

in United States call 1 800 – 800 – ASCO (2726)

or in Canada call 1 800 – 234 – ASCO (2726)

DISCONNECTING THE CONTROLLER

The harness disconnect plugs are furnished for repair purposes only and should not have to be unplugged. If the controller must be isolated, follow these steps:

Disconnecting the Plugs

WARNING

Do not unplug the controller until steps 1a or 1b is completed.

1. Observe the position of the transfer switch.
 - a. If the transfer switch is in the *Normal* position, first place standby engine starting control in the *off* position. Second, then open the emergency source circuit breaker. Third, open the normal source circuit breaker.
 - b. If the transfer switch is in the *Emergency* position, first open the normal source circuit breaker. Second, place the engine starting control in the *test* or *run* position. Third, open the emergency source circuit breaker.
2. Separate the two quick disconnect plugs by squeezing the latches. Do not pull on the harness wires.

Reconnecting the Plugs

WARNING

Do not unplug the controller until steps 1a or 1b is completed.

1. Observe the position of the transfer switch.
 - a. If the transfer switch is in the *Normal* position, first be sure that both normal and emergency source circuit breakers are open. Second, be sure that the standby engine starting control is still in the *off* position.
 - b. If the transfer switch is in the *Emergency* position, first be sure that both normal and emergency source circuit breakers are open.
2. The two harness plugs and sockets are keyed. Carefully align the plugs with the sockets and press straight in until both latches click. Close the door!
3. Restore the two sources in sequence as follows:
 - a. If the transfer switch is in the *Normal* position, first close the normal source circuit breaker. Second, close the emergency source circuit breaker. Third, place the standby engine starting control in the *automatic* position.
 - b. If the transfer switch is in the *Emergency* position, first close the emergency source circuit breaker. Second close the normal source circuit breaker.

TESTING & SERVICE (continued)

MANUAL LOAD TRANSFER

This procedure will manually transfer the load if the controller is disconnected.

WARNING

Do not manually operate the transfer switch until both power sources are disconnected (all conductors deenergized).

1. Deenergize both the normal and emergency source conductors (remove fuses or open circuit breakers).

2. Use the maintenance handle to manually operate the transfer switch to the opposite source. See *Manual Operation* on page 1–3.
3. Then remove the maintenance handle. See page 1–3.

WARNING

Verify that the maintenance handle has been removed before proceeding!

4. If the transfer switch is in the Emergency position manually start the engine generator and then install emergency source fuse or close the circuit breaker.

TROUBLE-SHOOTING

Note any optional accessories that may be furnished on the automatic transfer switch (ATS) and review their operation. Refer to any separate drawings and/or instructions that may be packed with the ATS.

DANGER

Hazardous voltage capable of causing shock, burns, or death is used in this switch. Do not touch the power or load terminals of the transfer switch!

Table 2-1. Trouble-Shooting Checks.

PROBLEM	CHECK IN NUMERICAL SEQUENCE		
	1 OPERATION	2 GEN-SET	3 VOLTAGE
Engine-generator set does not start when the Transfer Control switch is turned and held in <i>Transfer Test</i> position or when the normal source fails.	Hold <i>Transfer Test</i> switch 15 seconds or the outage must be long enough to allow for Feature 1C time delay plus engine cranking and starting time.	Starting control must be in the automatic position. Batteries must be charged and connected. Check wiring to engine starting contacts on customer terminal block TB. Verify that the small plug J3 is connected to receptacle P3.	–
Transfer switch does not transfer the load to the emergency source after the engine-generator set starts.	Wait for Feature 2B time delay to time out (if used).	Generator output circuit breaker must be closed. Generator frequency must be at least 95% of nominal (57 Hz for a 60 Hz system.) *	Voltmeter should read at least 90% of nominal phase to phase voltage between transfer switch terminals EA and EC (or EL1 and EL2 for 2 pole switches). *
Transfer switch does not transfer the load to normal source when normal returns or when the Transfer Control switch is released.	Wait for Feature 3A time delay to time out (if used).	–	Voltmeter should read at least 90% of nominal phase to phase voltage between transfer switch terminals NB and NC, NC and NA, and NA and NB (or NL1 and NL2 for 2 pole switches).
Engine-generator-set does not stop after load retransfer to the normal source.	Wait for Feature 2E time delay to time out (if used).	Starting control must be in the automatic position.	–

* These are factory settings. Refer to the **Group 5 Controller User's Guide**.

If the problem is isolated to circuits on the controller or the transfer switch, call your local ASCO Power Technologies sales office or ASI. In the United States, call 1–800–800–2726. In Canada, call 1–800–234–2726. Furnish the Serial No. and Catalog No. from the transfer switch nameplate.

INDEX

A

auxiliary circuits, 1–2

C

cable

lugs, 1–1

preparation, 1–1

catalog number, inside cover

cleaning, 2–1

connections

line, 1–1

contact position indicators, 1–3

controller, 1–1

disconnecting, 2–1

see *Controller User's Guide*

grounding, 1–1

E

electrical operation, 1–5

Emergency Source Accepted light,
1–4, 1–5

engine starting contacts, 1–2

F

frequency, generator, 2–2

functional test, 1–2, 1–3, 1–4, 1–5

G

ground, controller, 1–1

ground lugs, inside front cover

H

harness, 1–1

disconnect plugs, 2–1

HELP

customer@asco.com

800–800–ASCO

I

inspection, 2–1

installation, 1–1

indicators, contact position, 1–3

L

labels,

field terminal block TB, 1–2

rating, inside front cover

lights, 1–4, 1–5

lubrication, 2–1

M

maintenance handle, 1–3

illustration of, 1–3

warning, 1–3

maintenance, preventive, 2–1

manual load transfer, 2–2

warning, 2–2

manual operation, 1–3

illustration of, 1–3

warning, 1–3

N

nameplate, inside cover

Normal Source Accepted light, 1–4

O

operation

electrical, 1–5

manual, 1–3

illustration of, 1–3

warning, 1–3

optional accessories

see *Controller User's Guide*

P

parts, 2–1

phase rotation check, 1–4

problem, 2–2

R

rating label, inside cover

replacement parts, 2–1

S

settings

see *Controller User's Guide*

T

test, functional, 1–2, 1–3, 1–4, 1–5

time delays, 1–5, 2–2

see *Controller User's Guide*

Transfer Control selector switch

Retransfer Delay Bypass, 1–5

Transfer Test, 1–5

Transfer Switch Connected To

Emergency light, 1–4, 1–5

Transfer Switch Connected To

Normal light, 1–4, 1–5

transfer test, 1–5, 2–1

transfer to emergency, 1–5

transfer to normal, 1–5

trouble–shooting, 2–2

V

voltage checks, 1–4

voltage, pickup and dropout settings

see *Controller User's Guide*