



DYNAGENTM

TOUGH SeriesTM
TG410

User Manual



CONNECT. CONTROL. PROTECT.

Revision History

VERSION	DATE	NOTES
1.1	06/2014	Updated to include Rev 1.5 of the system wiring diagram.
2.0	03/2016	Updated to include Rev 3.0 of the typical wiring diagram. Updated Specs.
2.0	10/2018	Updated to include new drawing version, R2.0. Updated switched outputs in Spec. Updated power in Spec. Cutout drawing changed to one used in TE inserts (with cutouts for RP100).
7.0	09/2019	
A	09/2022	Document rebranded and contact information updated. Added French Translations for all DANGER/WARNING/CAUTION statements per UL Requirements.

Any information furnished by Cattron™ and its agents is believed to be accurate and reliable. All specifications are subject to change without notice. Responsibility for the use and application of Cattron products rests with the end user since Cattron and its agents cannot be aware of all potential uses. Cattron makes no warranties as to non-infringement nor as to the fitness, merchantability, or sustainability of any Cattron products for any specific or general uses. Cattron Holdings, Inc., or any of its affiliates or agents shall not be liable for incidental or consequential damages of any kind. All Cattron products are sold pursuant to the Terms and Conditions of Sale, a copy of which will be furnished upon request. When used as a tradename herein, Cattron means Cattron Holdings, Inc. or one or more subsidiaries of Cattron Holdings, Inc. Cattron™, corresponding logos, and other marks are trademarks or registered trademarks of Cattron Holdings, Inc. Other marks may be the property of third parties. Nothing herein provides a license under any Cattron or any third party intellectual property right.



Contents

1	Introduction	5
1.1	Specifications	6
2	Installation	9
2.1	General Wiring Notes	10
2.2	Terminal Descriptions	11
2.3	Wiring Harness	14
2.4	Typical Wiring Diagram	15
2.5	Typical Wiring Diagram with RelayPak	16
2.6	Wiring Considerations	17
2.6.1	Remote Start Contact (Start/Stop)	17
2.6.2	Emergency Stop Wiring	17
2.6.3	Universal Sensor	18
2.6.4	CANbus Wiring (J1939)	19
2.6.5	Modbus Wiring	20
2.6.6	Current Transformers	21
2.6.7	RelayPak (Optional)	23
3	Using the Controller	25
3.1	Modes, Starting and Stopping	26
3.1.1	Cranking Behavior	27
3.2	Using Cooldown Mode	28
3.3	Warnings	29
3.4	Failures	29
3.5	Events History	30
4	Settings	37
4.1	Operator Setup	37
4.2	Switched Inputs	38
4.2.1	Configurable Inputs	41
4.3	Switched Outputs	42
4.3.1	Group Outputs	46
4.3.2	Pull and Hold Coil	47
4.4	Sensors	48
4.4.1	Engine Temperature	48



4.4.2	Oil Pressure	50
4.4.3	Fuel Level.....	51
4.4.4	Engine Speed.....	52
4.4.5	Battery	57
4.4.6	Auxiliary Sensors	59
4.4.7	Custom Sender Tables	69
4.5	Timers	71
4.5.1	Engine Logic	71
4.5.2	Schedulers	78
4.5.3	Maintenance.....	81
4.6	AC Monitor	82
4.6.1	Generator Voltage.....	82
4.6.2	Generator Frequency.....	85
4.6.3	Generator Current.....	86
4.7	Communications	90
4.7.1	CANbus (J1939).....	90
4.7.2	Modbus (RS485).....	92
4.8	Other Config.....	92
4.8.1	Password	92
4.8.2	Settings Name / ID	92
4.8.3	Process Control.....	93
5	Troubleshooting	95
6	Technical Support.....	96



1 Introduction

The TOUGH Series controllers are designed to provide complete control, protection, AC metering, and engine instrumentation for both standard and electronic engines. The module is easily configured using either the front panel buttons or our RapidCore Configurator software. TOUGH Series controllers are ideally suited for severe duty applications where reliability is critical, such as mobile and stationary generators.



Tier 4 Ready



Features and Functions:

- Five-Year Warranty
- SAE J1939 CANbus Protocol
- RPM via J1939, Magnetic Pickup or Generator
- Speed control offset for electronic engines
- AutoStart on low battery and other sensors
- Trim feature for AC monitoring and sensors
- Maintenance counter
- Exerciser Clock
- 150 Event Log
- Conformally coated for protection against moisture
- Gasket for water ingress protection resistance
- Free RapidCore Configurator Software
- Fast and rugged installation clips
- Passcode protected
- Automatic shutdowns and warnings
- Manual and remote start options
- Momentary Start/Stop inputs
- Pre-heat and many other configurable timers
- Accepts common senders (VDO, Datcon, S&W)
- Custom senders configurable with RapidCore Configurator Software



Displays:

- Engine Temperature
- Oil Pressure
- Fuel Level
- Engine Speed
- AC Metering
- Battery Voltage
- Real Time Clock
- Engine Hours
- Time to Maintenance
- J1939 DTCs + Custom Text
- Custom Senders
- Warnings and Failures

Feature	Included
DPF / DEF Ready	✓
J1939 CANbus	✓
Isolated RS485 Modbus	✓
Magnetic Pickup Input	✓
150 Event Log	✓
Clock / Exerciser	✓
Generator Metering	Single or 3-Phase
Generator Current Metering (with IDMT and Load Imbalance features)	Single or 3-Phase
Configurable Switched Inputs	5
Resistive Sensors (1 High Ohm, 1 Low Ohm)	2
Universal Sensor (Resistive, 0-5V, 4-20mA)	2
5V Sensor Output for Electronic Sensors	✓
Configurable Switched Outputs	6

1.1 Specifications

The TOUGH Series controllers were rigorously tested to ensure durability, reliability and functionality. The following specifications are a brief summary of the standards to which the controller has been tested. For complete details on the testing performed, please contact Cattron at www.cattron.com.



Testing Specifications

Specification	Rating
Electrical Transients	SAE1113-11
Thermal Shock and Cycling	SAE1455
Vibration Profiles	SAE1455
Electric Static Discharge	SAE1113-13: +/-8 kV Direct Discharge +/-15 kV Air Gap Discharge
UL	 UL 6200 recognized component. Contact Cattron at www.cattron.com for UL conditions of acceptability.

Physical Specifications

Specification	Rating
Operating Temperature	-40 to +158 °F (-40 to +70 °C)
LCD Viewing Temperature	-4 to +158 °F (-20 to +70 °C) (Optional heater available, contact Cattron at www.cattron.com)
Weight	0.83 lb (0.38 kg)
Weight w/RelayPak	1.32 lb (0.60 kg)
Dimensions:	
- controller (no gasket)	4.17" x 6.50" x 1.38" (10.59 cm x 16.51 cm x 3.51 cm)
- controller with gasket	4.41" x 6.79" x 1.38" (11.20 cm x 17.25 cm x 3.51 cm)
- controller with gasket and RelayPak	4.41" x 6.79" x 3.33" (11.20 cm x 17.25 cm x 8.46 cm)

Electrical Specifications

Specification	Rating
Operating Voltage	5.5 ~ 36 VDC
Standby Current (Minimum)	Auto Mode: 60 mA @ 12 VDC, 38 mA @ 24 VDC (back lighting off) Off Mode: 80 mA @ 12 VDC, 45 mA @ 24 VDC (back lighting off) Actual consumption could be more depending on connected sensors and other I/O.
Switched Inputs	+Battery, Ground, Open, Closed
Switched Outputs	+Battery @ 1 A Max
Low Resistance Sensors	0 ~ 750 Ω
High Resistance Sensors	0 ~ 7,500 Ω



Specification	Rating
Universal Sensors	0 ~ 750 Ω, 0 ~ 7,500 Ω, 0 ~ 5 VDC, 4 ~ 20 mA
Magnetic Pickup	10 ~ 10,000 Hz at 1 ~ 50 VAC
AC Voltage (Line-To-Line)	<p>UL Approved Range: 50 ~ 600 VAC True RMS, Accuracy: 2% Full Scale</p> <p>Non-UL Range: 50 ~ 670 VAC</p> <p>Do not connect more than 600 VAC to the controller for UL approved installations, or 700 VAC for locations where UL is not required.</p>
AC Current	0 ~ 5 A (Current Transformer), Accuracy: 1% Full Scale
Communications	<p>SAE J1939 (Tier II, III, IV)</p> <p>Isolated RS485 (Slave Modbus RTU), 2.5 kV surges</p>
External Sensor Power	TG410 only: 5 VDC at a max load of 200 mA





2 Installation

Generator systems contain high voltage circuitry, and precautions should be taken to protect against electrical shock. Failing to power down and lock out equipment can cause damage, injury or death.

	WARNING
	WIRING OF THIS CONTROLLER SHOULD BE PERFORMED BY QUALIFIED ELECTRICIANS ONLY.

	AVERTISSEMENT
	LE CÂBLAGE DE CE CONTRÔLEUR NE DOIT ÊTRE EFFECTUÉ QUE PAR DES ÉLECTRICIENS QUALIFIÉS.

	CAUTION
	HIGH VOLTAGE MAY BE PRESENT AT THE CONTROLLER.

	ATTENTION
	UNE HAUTE TENSION PEUT ETRE PRESENTE AU NIVEAU DU CONTROLEUR.

The following general electrical safety precautions should be followed:

- Do a thorough inspection of the area before performing any maintenance
- Keep fluids away from electrical equipment
- Unplug connectors by pulling on the plug and not on the cord
- Use fuses where appropriate
- Ensure all equipment is properly grounded
- Provide support to wires to prevent stress on terminals

	CAUTION
	TO ENSURE PROPER AND SAFE OPERATION, CAUTION MUST BE TAKEN AT THE INSTALLATION SITE TO MAKE SURE IT IS FREE FROM EXCESSIVE MOISTURE, FLUCTUATING TEMPERATURE, DUST AND CORROSIVE MATERIALS.

	ATTENTION
	POUR GARANTIR UN FONCTIONNEMENT CORRECT ET SUR, IL FAUT PRENDRE DES PRECAUTIONS SUR LE SITE D'INSTALLATION POUR S'ASSURER QU'IL SOIT EXEMPT D'HUMIDITE EXCESSIVE, DE FLUCTUATIONS DE TEMPERATURE, DE POUSSIERE, ET DE MATERIAUX CORROSIFS.



Choose a mounting surface with the least amount of vibration and not more than 0.125" (3.175 mm) thick.

The following steps outline the mounting procedure:

1. Choose a suitable mounting location based on the criteria above.
2. Create a rectangular cut-out in the panel that is a minimum 3.9" (99 mm) high and 6.2" (158 mm) wide.
3. Place the controller into the panel cut-out so that the LCD screen and buttons are facing out.
4. Place the mounting clips into the designated slots on the top and bottom of the controller.
5. Tighten the screws on the clips until the controller is snug against the panel. Do not over-tighten. The bottom of the screws should angle very slightly away from the controller.
6. If applicable, snap the RelayPak (RP100) to the back of the controller. Place one side of the RP100's tabs into the slot on the back of the controller and, without pushing on the relays, snap the other tab into place.

The following figures show the TE Series cut-out dimensions and an image of the controller.

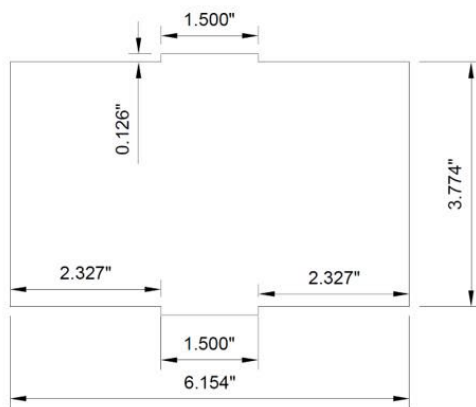

TE Series Cutout (Not To Scale)



2.1 General Wiring Notes

The following important wiring guidelines should be followed:

- Use a minimum of 18 AWG wire for all connections
- Battery Positive (+Battery) and Battery Negative connections on the controller should be run directly to the positive and negative terminals on the battery to prevent voltage drops from negatively impacting the controller
- Limit the wire length to 20 ft (6.1 m) to any I/O on the controller (e.g., Switched Input, Switched Outputs, AC Sensing and Analog Inputs)
- It is good practice to run the AC voltage sensing wiring to the controller in a separate conduit from the AC current sensing wiring. If the AC voltage is especially noisy (e.g., variable frequency drives), then they **MUST** be run separately



The TOUGH Series contains a TVS to protect the I/O and internals from a transient on the main battery (the battery from which the controller is powered). If you have I/O connected to other batteries or power supplies, those I/O must contain their own voltage transient protection. Otherwise, the I/O and/or controller can be damaged if the transient exceeds the maximum rated voltage of the I/O. A device that provides this kind of protection is known as a TVS or a varistor.

- The switched outputs already contain a kickback diode. Do not connect relays with an internal kickback diode to a switched output as the output may be shorted. This includes relays in the RelayPak
- Fusing:
 - A fuse should be placed in line with the battery positive wire going to the controller power; a 10 A fuse is suggested
 - The AC Voltage A, B and C lines should be fused near the source of AC voltage with a 1 A fuse to protect personnel if any of these lines becomes disconnected or damaged
 - If using the RelayPak, the power going to the relay commons should be fused
- For noisy environments, some guidelines are as follows:
 - Replace speed sensing wires with twisted pair from the sensor to the controller
 - Consider using isolated sensors (i.e., two terminal) and use twisted pair wiring to connect from the engine to the controller

When possible, the following enclosure guidelines should be followed:

- It is recommended that vibration mounts be used
- For outdoor applications, it is recommended that a sealed enclosure be used

2.2 Terminal Descriptions

Main Connector (J4)

Terminal	Name	Description
J4-1	+Battery	Provides power to the controller from the battery
J4-2	+Battery	Provides power to the controller from the battery
J4-3	Ground	Provides ground return for the controller
J4-4	Ground	Provides ground return for the controller
J4-5	Switched Input A	Configurable to detect +Battery, Ground, or Open
J4-6	Switched Input B	Configurable to detect +Battery, Ground, or Open
J4-7	Switched Input C	Configurable to detect +Battery, Ground, or Open
J4-8	Switched Output A	Outputs +Battery voltage when active (Max Current: 1 A)
J4-9	Switched Output C	Outputs +Battery voltage when active (Max Current: 1 A)
J4-10	Switched Output B	Outputs +Battery voltage when active (Max Current: 1 A)
J4-11	Sensor Ground	Provides ground return for 2-wire (isolated) sensors



Terminal	Name	Description
J4-12	Sensor Input A	High impedance sensor input (0-7,500 Ω)
J4-13	Sensor Input B	Low impedance sensor input (0-750 Ω)
J4-14	Sensor Input C	Universal sensor input (0-750 Ω, 0-7,500 Ω, 0-5 VDC, 4-20mA). See the Universal Sensor section for more information.

Expansion Connector (J3)

Terminal	Name	Description
J3-1	Switched Input D	Configurable to detect +Battery, Ground, or Open
J3-2	Switched Input E	Configurable to detect +Battery, Ground, or Open
J3-3	Switched Output D	Outputs +Battery voltage when active (Max Current: 1 A)
J3-4	Switched Output E	Outputs +Battery voltage when active (Max Current: 1 A)
J3-5	Switched Output F	Outputs +Battery voltage when active (Max Current: 1 A)
J3-6	Sensor 5 V	Provides 5 VDC for electronic sensors
J3-7	Sensor Ground	Provides ground return for 2-wire sensors
J3-8	Sensor Input D	Universal sensor input (0-750 Ω, 0-7,500 Ω, 0-5 VDC, 4-20 mA). See the Universal Sensor section for more information.

Communications Connector (J6)

Terminal	Name	Description
J6-1	RS485 + (Non-Inverting)	Non-Inverting communications line for Modbus (RS485). This is also often known as A.
J6-2	RS485 - (Inverting)	Inverting communications line for Modbus (RS485). This is also often known as B.
J6-3	No Connection	No Connection
J6-4	CAN-H	Communications line for CANbus (J1939)
J6-5	CAN-L	
J6-6	CAN-Shield	Connect the shield of the twisted pair cable to this terminal.
J6-7	Speed Sensing A	Connect to a magnetic pickup, tachometer, or a flywheel alternator. Not polarity sensitive and not required if using AC voltage terminals for speed sensing.
J6-8	Speed Sensing B	Connect to a magnetic pickup, tachometer, or a flywheel alternator. Not polarity sensitive and not required if using AC voltage terminals for speed sensing.
J6-9	No Connection	No Connection
J6-10	RS485-Common	Common line for Modbus (RS485)



Generator AC Voltage (J7)

Terminal	Name	Description
J7-1	Phase A	Connect to Phase A of the generator
J7-2	Phase B	Connect to Phase B of the generator
J7-3	Phase C	Connect to Phase C of the generator
J7-4	Neutral	Connect to neutral of the generator

Generator AC Current (J5)

Terminal	Name	Description
J5-1	Phase A	Connect to current transformer for Phase A of the generator
J5-2	Phase B	Connect to current transformer for Phase B of the generator
J5-3	Phase C	Connect to current transformer for Phase C of the generator
J5-4	CT Common	Connect to the commons of the current transformers



2.3 Wiring Harness

Terminal	Color	Wire Text	Description
J6-1	Not Populated		
J6-2	Not Populated		
J6-3	Not Populated		
J6-4	White	CAN/HIGH	CAN/J1939 High
J6-5	White	CAN/LOW	CAN/J1939 Low
J6-6	White	CAN GND	CAN/J1939 Shield
J6-7	Green	SPEED INPUT	Speed Input
J6-8	Green	SPEED REF	Speed Reference
J6-9	Not Populated		
J6-10	Not Populated		

Terminal	Color	Wire Text	Description
J6-1	Blue	RS485 A	Modbus A (+)
J6-2	Blue	RS485 B	Modbus B (-)
J6-3	Not Populated		
J6-4	Black	CAN HIGH	CAN/J1939 High
J6-5	Black	CAN LOW	CAN/J1939 Low
J6-6	Black	CAN GND	CAN/J1939 Shield
J6-7	Green	SPEED INPUT	Speed Input
J6-8	Green	SPEED REF	Speed Reference
J6-9	Not Populated		
J6-10	Blue	RS485 GND	RS485 Common

Terminal	Color	Wire Text	Description
J4-1	Red	BATT POS	Battery Positive
J4-2	Not Populated		
J4-3	Black	BATT NEG	Battery Negative
J4-4	Black	BATT NEG	Relay/Pak Coil -
J4-5	Tan	SW IN A	Switched Input A
J4-6	Tan	SW IN B	Switched Input B
J4-7	Tan	SW IN C	Switched Input C
J4-8	Purple	SW OUT A Fuel	Relay/Pak relay A
J4-9	Purple	SW OUT B Crank	Relay/Pak relay B
J4-10	Purple	SW OUT C	Relay/Pak relay C
J4-11	Brown	SEN IN A	Sensor Input A
J4-12	Brown	SEN IN A	Sensor Input A
J4-13	Brown	SEN IN B	Sensor Input B
J4-14	Brown	SEN IN C	Sensor Input C

Terminal	Color	Wire Text	Description
J4-1	Red	BATT POS	Battery Positive
J4-2	Not Populated		
J4-3	Black	BATT NEG	Battery Negative
J4-4	Not Populated		
J4-5	Tan	SW IN A	Switched Input A
J4-6	Tan	SW IN B	Switched Input B
J4-7	Tan	SW IN C	Switched Input C
J4-8	Purple	SW OUT A	Switched Output A
J4-9	Purple	SW OUT B	Switched Output B
J4-10	Purple	SW OUT C	Switched Output C
J4-11	Brown	SEN GND	Sensor Ground
J4-12	Brown	SEN IN A	Sensor Input A
J4-13	Brown	SEN IN B	Sensor Input B
J4-14	Brown	SEN IN C	Sensor Input C

Terminal	Manufacturer	Housing P/N	Crimps P/N
J3	Molex	39-01-2090	39-00-0039
J4	Molex	39-01-140	39-00-0039
J5/J7 - AC Voltage	Tyco	1-480702-0	350536-1
J5 - AC Current	Molex	39-01-12100	350218-1
J6	Molex	39-01-2060	39-00-0039
Relay/Pak J1	Molex	39-01-2060	39-00-0039

Notes:
(1) Harnesses are 5 feet in length except for the three DWG1522 RS485 wires which are 6 inches in length.

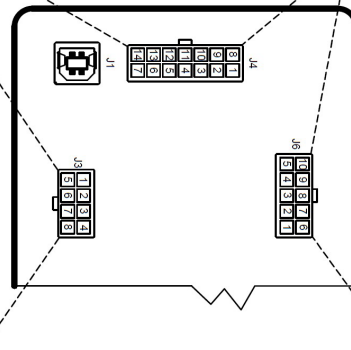

Terminal	Color	Wire Text	Description
J3-1	Tan	SW IN D	Switched Input D
J3-2	Tan	SW IN E	Switched Input E
J3-3	Purple	SW OUT D	Switched Output D
J3-4	Purple	SW OUT E	Switched Output E
J3-5	Purple	SW OUT F	Switched Output F
J3-6	Not Populated		
J3-7	Brown	SEN GND	Sensor Ground
J3-8	Brown	SEN IN D	Sensor Input D

Terminal J3-3 is left unpopulated from the factory and can be populated using one of the two individual wires that came with the harness (a short one with two crimps on both sides and a long one with a crimp on one side and a pigtail on the other). If using relay D on the Relay/Pak insert one end of the short wire into J3-3 and the other end into Relay/Pak J1-1. If you are not using the relay pack insert the longer wire into J3-3.

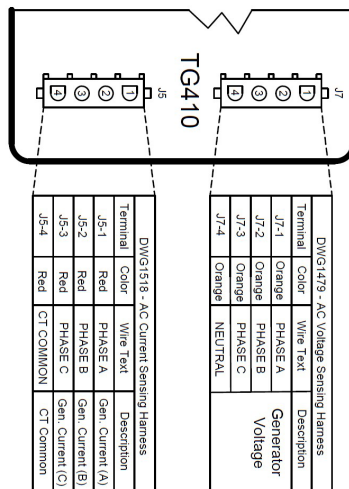

Terminal	Color	Wire Text	Description
J5-1	Red	PHASE A	Gen Current (A)
J5-2	Red	PHASE B	Gen Current (B)
J5-3	Red	PHASE C	Gen Current (C)
J5-4	Red	CT COMMON	CT Common

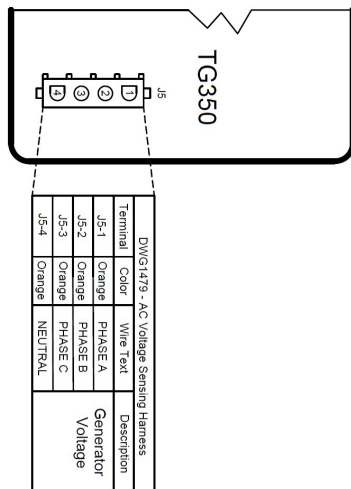

Terminal	Color	Wire Text	Description
J5-1	Orange	PHASE A	Generator Voltage
J5-2	Orange	PHASE B	Generator Voltage
J5-3	Orange	PHASE C	Generator Voltage
J5-4	Orange	NEUTRAL	Generator Voltage

Tough Series Harness Guide
DWG-1547R2.0



2.4 Typical Wiring Diagram

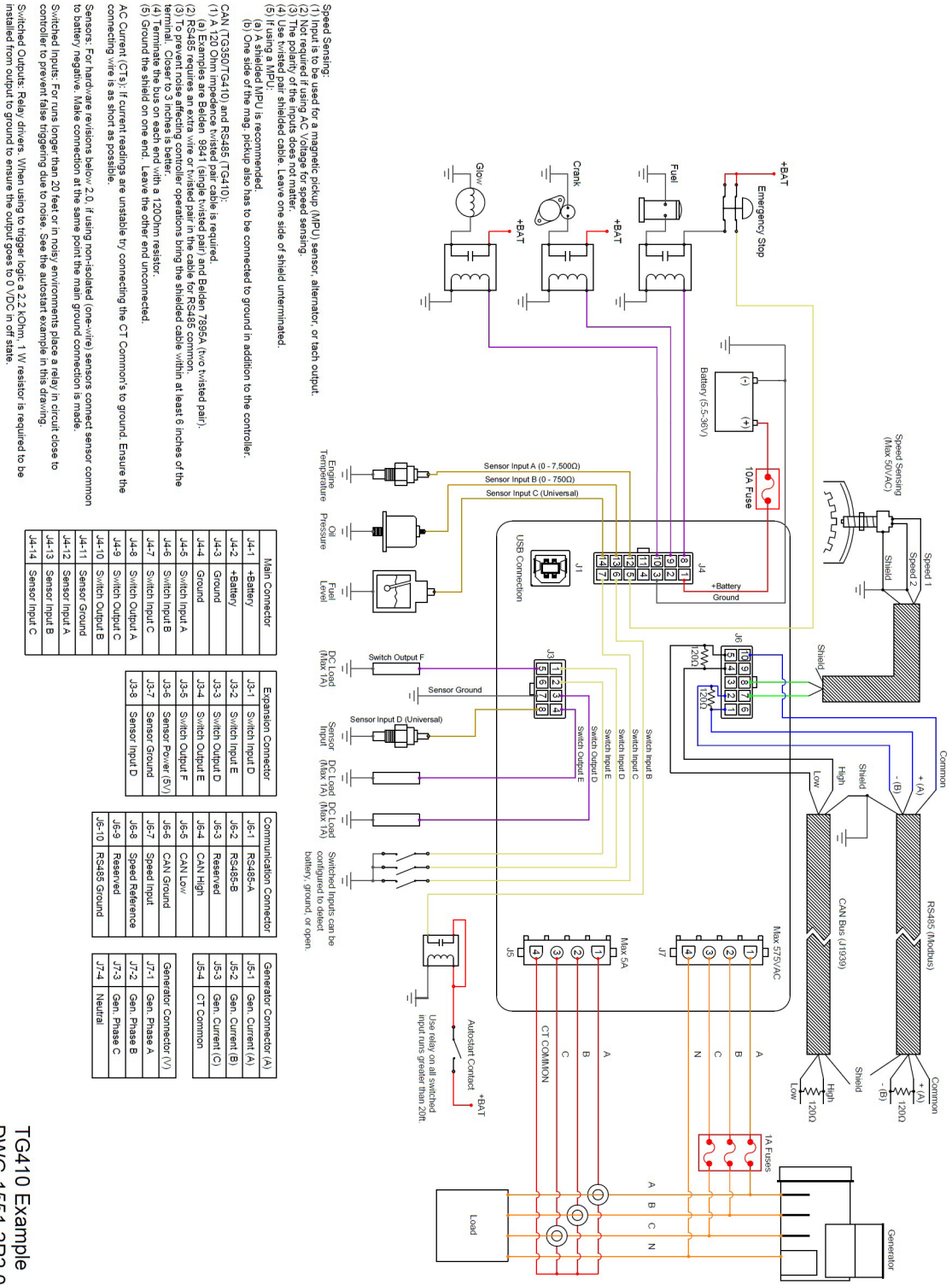

TG410 Example
DWG-1551-2R.0



2.5 Typical Wiring Diagram with RelayPak

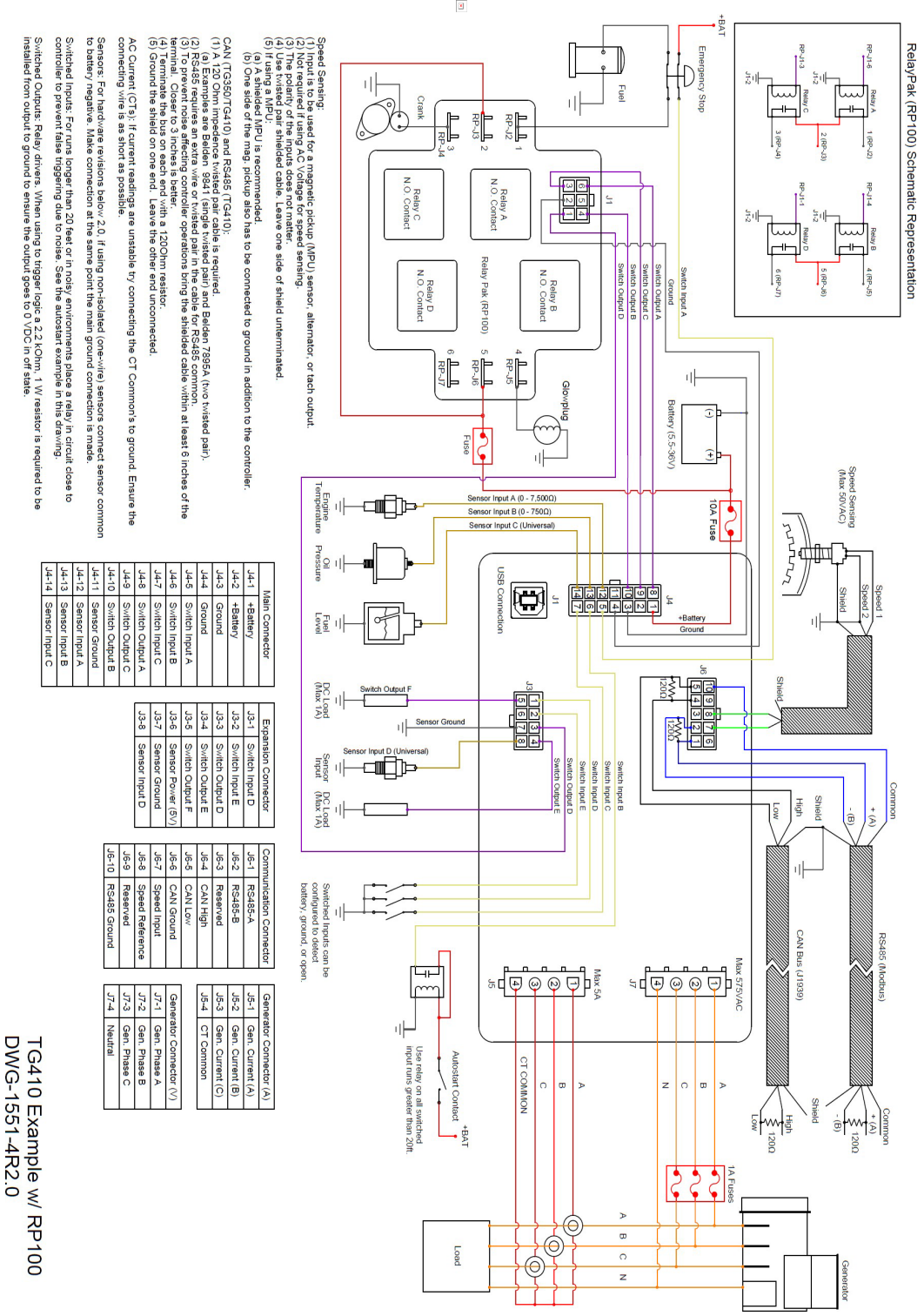

TG410 Example w/ RP100
DWG-1551-4R2.0

Main Connector		Expansion Connector		Communication Connector		Generator Connector (A)	
J4-1	+Battery	J3-1	Switch Input D	J5-1	RS485-A	J7-1	Gen. Phase A
J4-2	+Battery	J3-2	Switch Input E	J5-2	RS485-B	J7-2	Gen. Phase B
J4-3	Ground	J3-3	Switch Output D	J5-3	Reserved	J7-3	Gen. Current (B)
J4-4	Ground	J3-4	Switch Output E	J5-4	CAN High	J7-4	CT Common
J4-5	Switch Input A	J3-5	Switch Output F	J5-5	CAN Low	J7-5	Gen. Phase A
J4-6	Switch Input B	J3-6	Sensor Power (5V)	J5-6	CAN Ground	J7-6	Gen. Phase B
J4-7	Switch Input C	J3-7	Sensor Ground	J5-7	Speed Input	J7-7	Gen. Phase C
J4-8	Switch Output A	J3-8	Sensor Input D	J5-8	Reserved	J7-8	Neutral
J4-9	Switch Output B			J5-9	RS485 Ground		
J4-10	Switch Output C			J5-10	RS485 Ground		
J4-11	Sensor Input A						
J4-12	Sensor Input B						
J4-13	Sensor Input C						
J4-14	Sensor Input C						



2.6 Wiring Considerations

The following sections are meant to describe certain wiring configurations and are for illustrative purposes only. Not all applications are the same. Please ensure that you modify these examples to fit your unique system requirements.

2.6.1 Remote Start Contact (Start/Stop)

As of firmware version 1.60, the Start/Stop is factory defaulted to switch input B (changeable) and the trigger is factory defaulted to Close +BAT. For older firmware versions, you must set Start/Stop to Switched Input B or as desired and set the trigger mode to Close +BAT. The trigger can be set to any of four options but Close +BAT gives the best immunity to noise.

For runs over 20 ft (6.1 m), especially in noisy environments, Cattron recommends connecting the Start/Stop to an external relay. The relay needs to be located as close to the controller as possible.

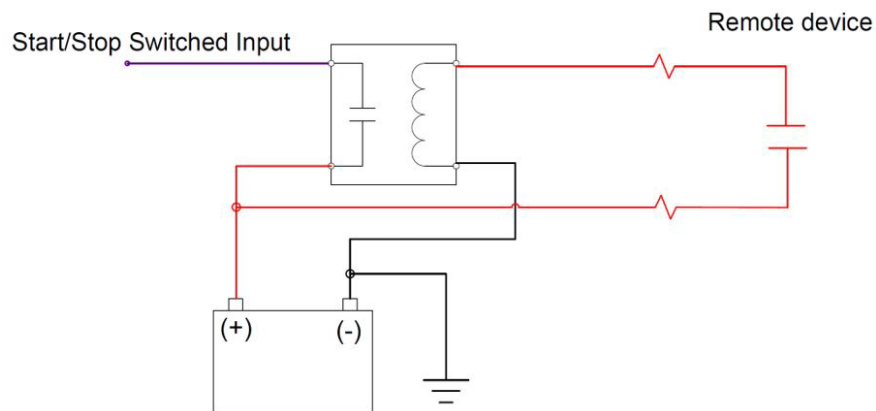

2.6.2 Emergency Stop Wiring

If Emergency Stop functionality is required, it must be an external mushroom-style switch wired in series with the fuel or ignition supply to ensure reliable and immediate shutdown upon activation.

The following figure shows is an example wiring diagram of a double pole, single throw switch being used to activate the e-stop input and cut power to the fuel solenoid. In this configuration, the e-stop is activated when there is an open circuit to the switched input, and it is inactive when the input detects battery positive voltage.

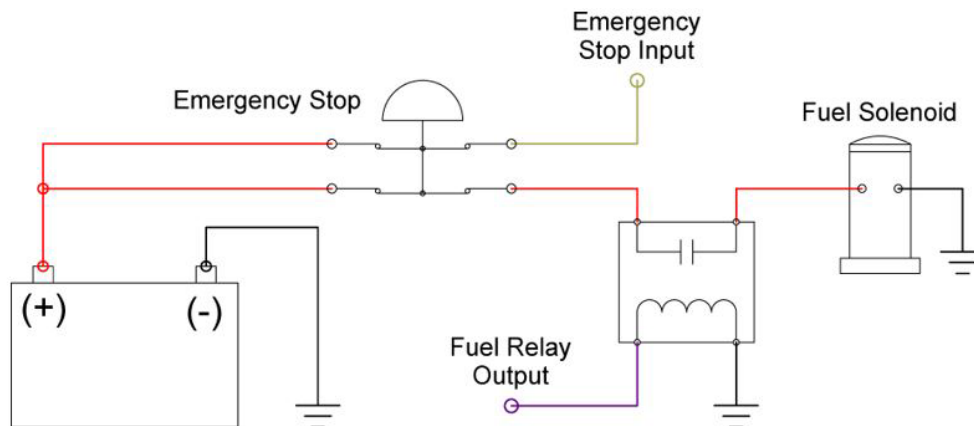

2.6.3 Universal Sensor

Universal Sensors have the ability to be configured to detect different sender types (0-750 Ω, 0-7,500 Ω, 0-5 VDC, 4-20 mA). The examples shown below are advanced applications of the universal sensor.

	<p>CAUTION</p> <p>CUSTOM SENDER TABLES ARE REQUIRED FOR THE UNIVERSAL SENSOR TO WORK WITH THESE EXAMPLES. SEE THE CUSTOM SENDER TABLES SECTION FOR MORE INFORMATION.</p>
---	---

	<p>ATTENTION</p> <p>LES TABLEAUX CUSTOM SENDER (EMETTEUR PERSONNALISE) SONT NECESSAIRES POUR QUE L'EMETTEUR UNIVERSEL FONCTIONNE AVEC CES EXEMPLES. VOIR LA SECTION CUSTOM SENDER TABLES (TABLEAUX DE CAPTEURS PERSONNALISES) POUR PLUS D'INFORMATIONS.</p>
---	--

Example #1: The following example shows the correct way to wire a 4-20 mA sensor. The 240 Ω resistor is required to transform the 4-20 mA current into the 0-5 V voltage range required by the controller.

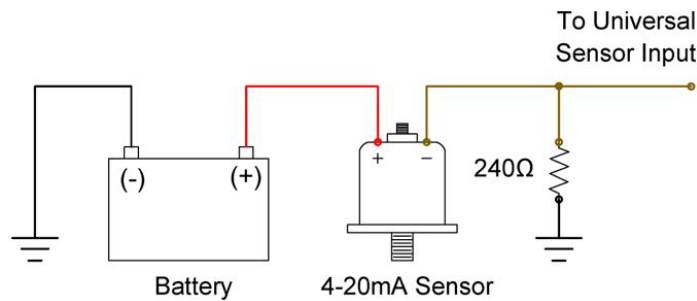

4-20 mA Wiring Example

Example #2: Sometimes it is required to measure voltages outside the 0-5 V range allowed by the controller. To do this you must use a voltage divider with appropriate scaling resistors. The equation to calculate the resistor values is as follows:

$$V_{OUT} = (R1/(R1+R2)) \times V_{IN}$$

Where: $V_{OUT} = 5\text{ V}$

V_{IN} = Maximum Voltage to Read

$R1$ = Common Resistor Value > 10 kΩ

$R2$ = Calculated Resistor Value (select closest common resistor value)

The following diagram shows the typical wiring of a voltage divider. The resistors' values have been selected to allow the controller to read up to 36 V from an external battery bank.



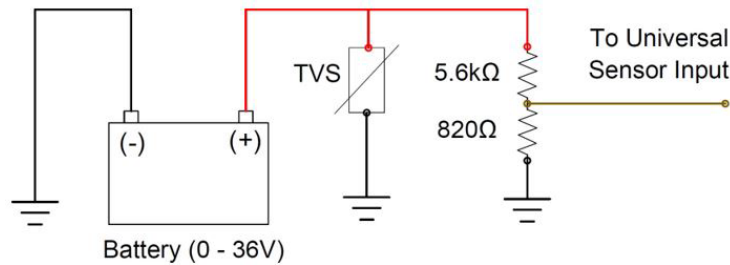

0-36 V Wiring Example

	CAUTION
A TVS (I.E., VARISTOR) IS REQUIRED IF THE BATTERY IS DIFFERENT THAN THE BATTERY FROM WHICH THE CONTROLLER IS POWERED. THE CONTROLLER'S TVS CANNOT PROTECT THE SENSOR INPUT FROM TRANSIENTS IN THIS CASE.	

	ATTENTION
UN TVS (VARISTANCE) EST NECESSAIRE SI LA BATTERIE EST DIFFERENTE DE CELLE QUI ALIMENTE LE CONTROLEUR. DANS CE CAS, LE TVS DU CONTROLEUR NE PEUT PAS PROTEGER L'ENTREE CAPTEUR CONTRE LES TRANSITOIRES.	

2.6.4 CANbus Wiring (J1939)

The following table outlines some items that must be taken into consideration when connecting to a CANbus engine.

Consideration	Description
Bus Termination	Each end of the bus must be terminated from CAN H to CAN L with 120 Ω +/- 10 Ω resistors. The resistor must be able to handle at least 400 mW of power dissipation.
Cable Selection	A twisted pair 120 Ω impedance cable is required for communications. For better protection, a shielded twisted pair cable is recommended. Examples include the following: <ul style="list-style-type: none"> • Belden 9841 - Shielded cable with one twisted pair, 24 AWG • Belden 7895A - Shielded cable with two twisted pair, 20 AWG For short runs of 5 ft or less, regular 18 AWG wiring can often be run.
Shielding	If using a shielded cable, the shield must be connected to ground on one end of the bus only. This prevents loss of data from electromagnetic interference.
Termination at the Controller	The twisted pair cable must terminate no farther than six inches from the controller's CAN (J1939) connector. Three inches is ideal.



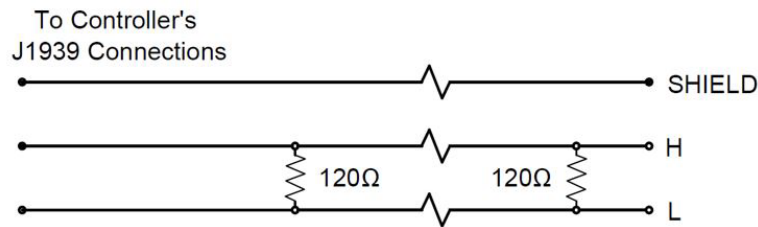

Communications Wiring

It is common practice to use the fuel output to trigger the ECM key input to enable the ECM before cranking. For some ECMs to function, they must be powered/enabled for a certain period before cranking to allow time for the ECM to boot up. There are two ways to provide this time:

- Set a preheat time or increase the preheat time to allow a longer time for the ECM to boot up before cranking; the fuel output turns on at the start of preheat
- Enable the Auto Power ECM setting in the Communications > CANbus (J1939) menu, which will cause the fuel output to turn on in Auto Mode and stay on

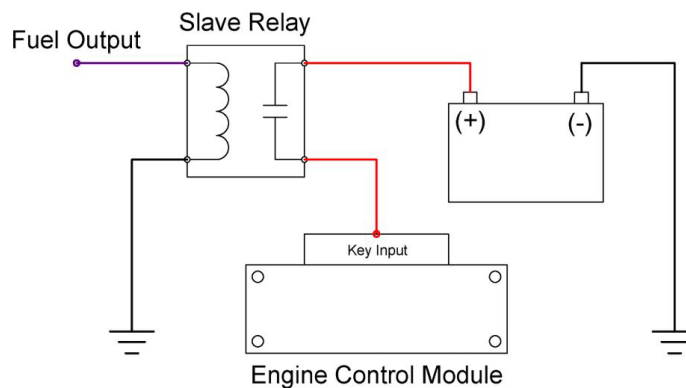

ECM Wiring

2.6.5 Modbus Wiring

The following table outlines some items that must be taken into consideration when connecting up a Modbus system.

Consideration	Description
Bus Termination	Each end of the bus must be terminated from A to B with 120 Ω +/- 10 Ω resistors. The resistor must be able to handle at least 400 mW of power dissipation.
Cable Selection	Shielded twisted pair 120 Ω impedance cable is required for communications. Shield drain wire is NOT to be used for the RS485 common. The cable must have one twisted pair for A and B and a separate wire or twisted pair for common. An example is Belden 7895A, a two twisted pair, 20 AWG, where the second pair can be used for the RS485 common.



Consideration	Description
Distance (Power and Ground)	<p>If you are running power and ground from the battery of your system to a remote device, use the following guidelines for the gauge of the power and ground wires:</p> <ul style="list-style-type: none"> • Up to 450 ft (137.2 m) – 22 AWG • Up to 700 ft (213.4 m) – 20 AWG • Up to 1125 ft (342.9 m) – 18 AWG • Up to 1800 ft (548.6 m) – 16 AWG • Up to 2800 ft (853.4 m) – 14 AWG
Termination at the Controller	The above cable must terminate no farther than six inches from the controller's RS485 (Modbus) connector. Three inches is ideal.

Refer to the Example wiring diagram for a wiring example.

2.6.6 Current Transformers

When wiring current transformers (CTs) into the system, you must follow these considerations:

- The maximum amperage allowed on the secondary is 5 A. A 5:X ratio CT should be used where X is the maximum primary amperage rating (e.g., 200 A)
- The CT power rating should be a minimum of 1 V·A
- The controller CT burden is 0.02 Ω (0.5 V·A)
- The current transformer of each phase must be facing the same direction, as shown in the following figure
- The CT Common connection must be connected to the black wire on each CT
- The wires from the current transformers to the controller should be as short as possible
- The CT wires should be run in a separate conduit from the AC voltage wires

	CAUTION
	IF READINGS ARE UNSTABLE WITH THE CONFIGURATION SHOWN IN THE FOLLOWING FIGURE, ATTEMPT TO CONNECT THE CT COMMON'S BLACK WIRE TO THE NEGATIVE TERMINAL OF THE BATTERY. ENSURE THE CONNECTING WIRE IS AS SHORT AS POSSIBLE.

	ATTENTION
	SI LES RELEVES SONT INSTABLES AVEC LA CONFIGURATION CI-DESSOUS, ESSAYEZ DE CONNECTER LE FIL NOIR COMMUN (COMMUN) DU CT (TRANSFORMATEUR DE COURANT) A LA BORNE NEGATIVE DE LA BATTERIE. ASSUREZ-VOUS QUE LE FIL DE CONNEXION SOIT AUSSI COURT QUE POSSIBLE.



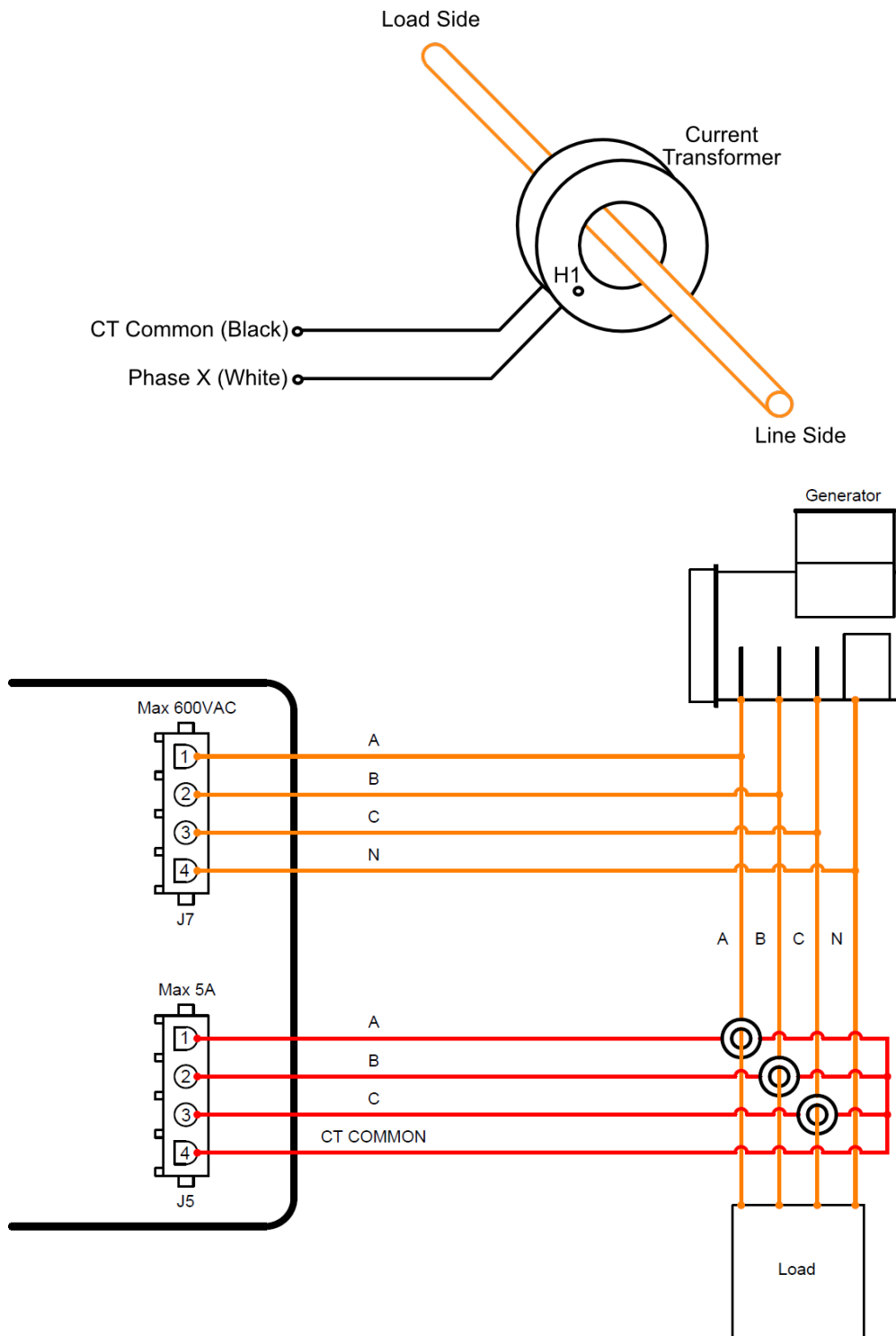

CT Wiring



2.6.7 RelayPak (Optional)

Model Number: RP100

The RelayPak is used to provide up to four built-in slave relays in a compact and easy to wire package. This allows the low current outputs of the controller to switch on high current relays on the RelayPak.

Note: The RelayPak can be used to sense DC voltages up to 39 VDC using one of the Auxiliary Sensor Inputs on the controller. The VM in RP100-VM refers to this voltage sensing capability. Refer to drawing DWG1552 at www.cattron.com. If this capability is used, the fourth relay, Relay D, cannot be used.

Electrical Specifications

Specification	Rating
Operating Voltage	12 V / 24 V
Output Pilot Duty Rating	5.83 A Per Relay @ 12 V
Output Resistive Rating	10 A Continuous Per Relay @ 12 V 40 A Momentary Per Relay @ 12 V
Relay Style	Automotive Cube
Standards	 UL 6200 recognized component. Contact Cattron at www.cattron.com for UL conditions of acceptability.

	WARNING
	YOU MUST USE RELAYS IN THE RELAYPAK THAT ARE SUITABLE FOR THE SYSTEM VOLTAGE; FOR EXAMPLE, 12 V RELAYS IN A 12 V SYSTEM AND 24 V RELAYS IN A 24 V SYSTEM.

	AVERTISSEMENT
	VOUS DEVEZ UTILISER DES RELAIS ADAPTES A LA TENSION DU SYSTEME DANS LE RELAYPAK. PAR EXEMPLE, DES RELAIS 12 V POUR UN SYSTEME 12 V, ET DES RELAIS 24 V POUR UN SYSTEME 24 V.



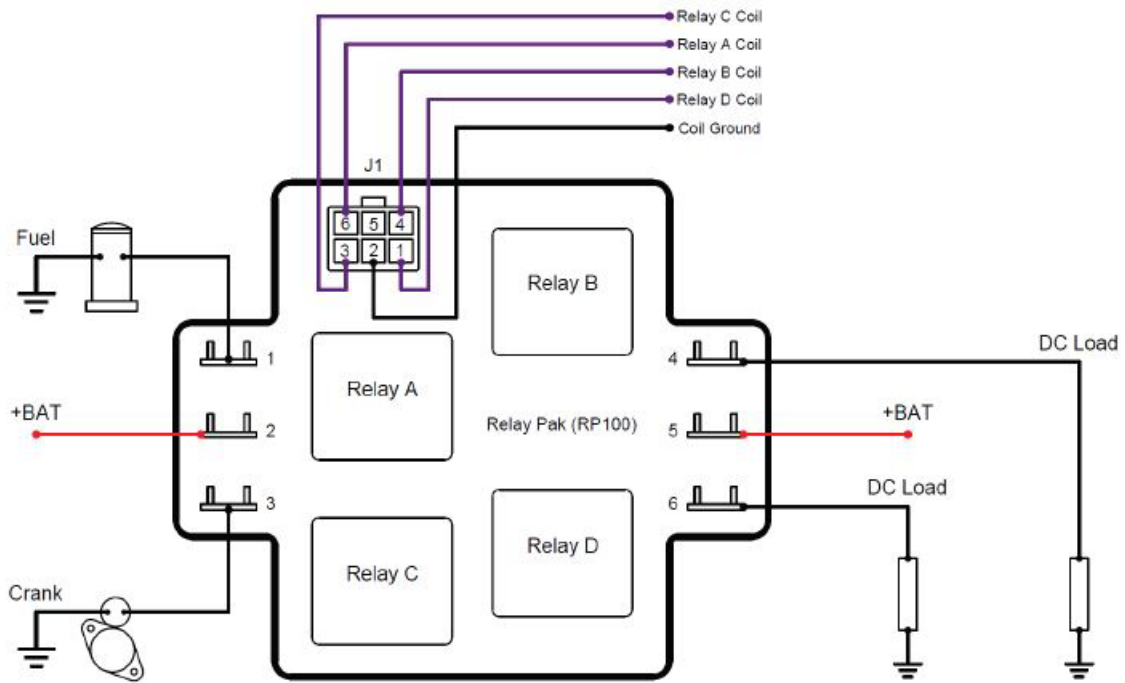

Schematic Representation

Relay Pak Connector	
J1-1	Relay D Coil
J1-2	Coil Ground
J1-3	Relay C Coil
J1-4	Relay B Coil
J1-5	
J1-6	Relay A Coil
1	Relay A Contact
2	A and C Common
3	Relay C Contact
4	Relay B Contact
5	B and D Common
6	Relay D Contact

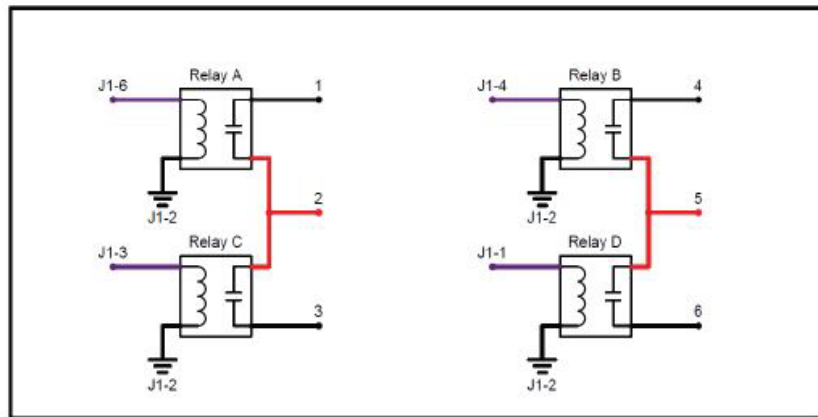

3 Using the Controller

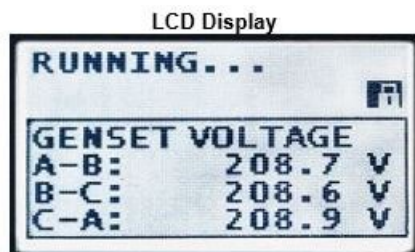

The LCD display is the primary source of information from the controller. It allows you to view/change settings and monitor the status of sensors and other engine peripherals.







Using the Menu System

Task	Description
Entering Menu	When in the Off Mode, press the Enter button to bring up the menu.
Navigating Menu	Once in the menu, use the up and down arrows to navigate. Pressing Enter will move you into that menu.
Change a Setting	Scroll to the desired value and press Enter to select. A check mark should appear beside that item. Press Enter again to save the setting and return to the previous screen.
Scroll Parameters	When in Auto or Running Mode, pressing the up and down arrows will scroll through the parameter pages.
Lock Screen	When in Auto or Running Mode, the screen can be locked to a certain parameter page by pressing Enter and unlocked by pressing Enter again.
Events History	Once in the menu, select Events History to view the most recent controller event. Use the up and down arrows to navigate to other events. The controller can store up to 150 events. If more than 150 events occur, the oldest event is deleted to make room for the next event.

Front Panel Items

Item / Symbol	Name	Description
	OFF Button	Used for turning off the engine or exiting out of Auto Mode. This is not intended to function as an Emergency Stop as there are conditions in which it will not shut down the engine. See the OFF Button Function section for more information.
	AUTO Button	Used for placing the controller into Auto Mode. Once in Auto Mode, the controller waits for a start command to be received.
	RUN Button	Used to start the engine manually. The OFF button must be used to shut down the engine if it has been started using the front panel.



Item / Symbol	Name	Description
	Up Button	Used for moving around in the menu, changing a setting's value, or changing the currently displayed parameter page.
	Enter Button	Used for entering the menu system, accepting settings, or locking the LCD screen when viewing parameters.
	Down Button	Used for moving around in the menu, changing a setting's value, or changing the currently displayed parameter page.
	Generator/Engine LED	Green = Engine running with no issues Amber = Engine running with warnings Red = Engine shut down on failure

3.1 Modes, Starting and Stopping

The following table describes the operating modes of the controller.

Mode/State	Description
Off	When in the Off Mode, the engine cannot be remotely started.
Auto	When in the Auto Mode, the engine waits to receive a start command.
Running	When engine is Running, the controller monitors engine parameters and waits to receive a stop command.
Failure	When a Failure occurs, the controller shuts down the engine and displays the reason for failure. The unit must be reset using the front panel OFF button, with the exception of Modbus.
Menu	When in the Menu Mode, settings can be changed, and the Events History may be viewed.

The following table describes the different methods for starting a controller. Unless you are using the Manual Run method to start the controller, the controller must be in Auto Mode.

Starting Methods

Methods	Description
Manual Run	Pressing the RUN button will start the engine. You must press the OFF button to shut down the engine.
Start / Stop Switched Inputs	When this input is active, the engine will start. When the input becomes inactive, the engine will shut down.
Momentary Switched Inputs	Switched inputs Momentary Start and Momentary Stop can be used for starting and stopping of the engine. Unlike other inputs, they only have to be activated for a short period of time.
Battery Recharge	When the battery voltage drops below a certain level, the engine will start and run for a predetermined amount of time.



Methods	Description
Exerciser	When the scheduled exerciser interval occurs, the engine will start and run for a predetermined amount of time.
Week Scheduler	When a scheduled event occurs, the engine will start and run for the programmed amount of time.
Auxiliary Sensors	When a properly configured Auxiliary sensor falls below / rises above a certain point, the engine will start as determined by the Auxiliary Sensors > Mode Select settings.
Modbus Start	When a certain command is sent to the controller over Modbus, the engine will start. See the TOUGH Series Modbus Reference Manual for more information.
J1939 Start	Start/stop command sent over the J1939 CANbus; for example, from the TR100 or a remote telemetry device. The controller will display either “J1939 Run” or “J1939 Remote” as the reason for starting.
ECM Power On	<p>This is not a starting mode like the others. In Auto Mode, if the AUTO button is held for 3 seconds, the fuel output is turned on for 1 hour. “ECM Power On” will be displayed on the screen.</p> <p>Pressing and holding the AUTO button again within the hour will refresh for another hour. This feature can be used to turn on or activate equipment powered by the fuel output. Often this is used by a tech to power the ECM on an electronic engine so that a diagnostic tool can obtain information from the ECM.</p>

	WARNING
	SEE THE USING COOLDOWN MODE SECTION FOR MORE INFORMATION ON HOW IT AFFECTS STARTING AND STOPPING.

	AVERTISSEMENT
	VOIR LA SECTION USING COOLDOWN MODE (UTILISATION DU MODE REFROIDISSEMENT) POUR PLUS D'INFORMATIONS SUR LA FAÇON DONT CELA PEUT AFFECTER LE DÉMARRAGE ET L'ARRÊT.

3.1.1 Cranking Behavior

Crank disconnect is only monitored at the beginning of cranking. If the engine is already running, the starter motor (output set to Crank) may turn on briefly.

If the controller is programmed to use CAN J1939 or a magnetic pickup (sensor or alternator output), the controller will also monitor the AC Voltage Phase A line for frequency as a backup or secondary means of crank disconnect. This occurs even if AC Voltage sensing is disabled in the settings.

The oil pressure is not used as a means of crank disconnect.



3.2 Using Cooldown Mode

When the controller is configured to have a cooldown period (see the [Engine Logic](#) section) for the engine, there is some special functionality that must be considered.

The cooldown period is special in that during this time, it will accept a Start command. This means if the engine is cooling down and a start command is received, the controller will be placed back into a Running Mode and will not shut down.

The following is an example of how the cooldown functionality works; this process is also shown in the following figure.

1. Remote Start contacts close.
2. Engine starts and is in Running Mode.
3. Remote Start contacts open.
4. Engine starts cooldown period.
5. User presses RUN button on the front panel.
6. Engine moves back into Running Mode and does not shut down.
7. Engine can now only be shut down by using the OFF button or Emergency Stop input.

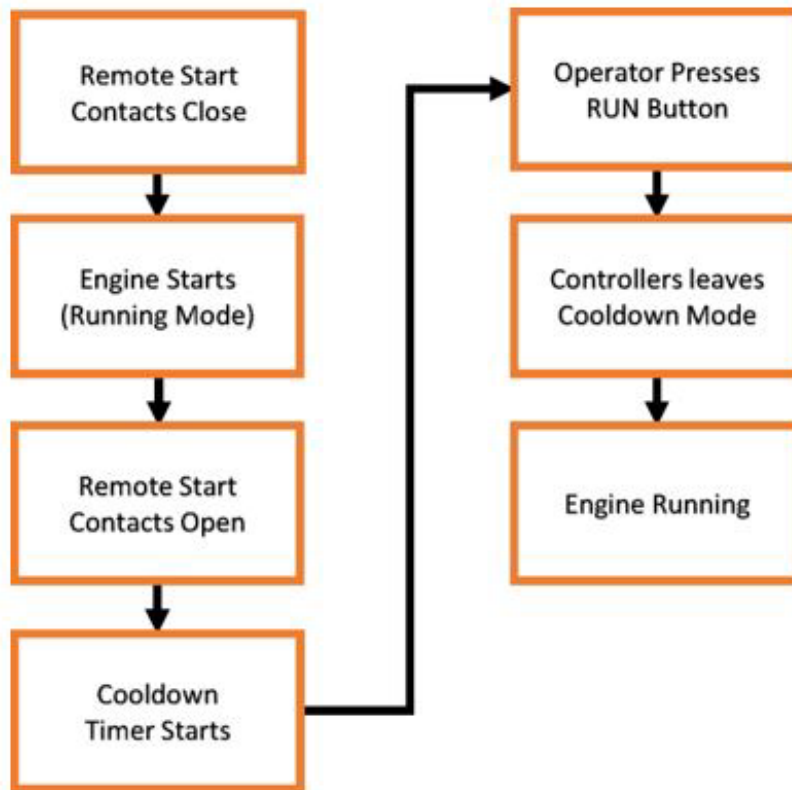

3.3 Warnings

Warnings are conditions that alert the user to possible issues. These get enabled/disabled when you enable/disable various settings in the controller.

Notable warnings are given in the following table.

Warning Name	Enabled Condition(s)	Description
High Fuel Level	High Fuel Level not disabled (in Sensors > Fuel Level menu).	High Fuel Level warning. This is often used to indicate an over fueling condition where fuel could be overflowing from the fuel tank.
Low Engine Temp	Low Engine Temp not disabled (in Sensors > Engine Temp. menu).	Low Engine Temperature warning. This is often used to indicate a malfunction of the engine block heater in stationary generator applications.
Low Oil Pressure	Switched input set to "Oil Pres. Warn" function. See the Switched Inputs section. Triggered if switched input is active during the Run Mode.	Low oil pressure warning.

3.4 Failures

Failures are conditions that cause the controller to shut down to prevent damage to the engine or generator. These get enabled/disabled when you enable/disable various settings in the controller.

Notable failures are given in the following table.

Failure Name	Enabled Condition(s)	Description
ECM Communication Failure	Enabled if loss of ECM communication is enabled. See CANbus (J1939) section. J1939 feature.	If the controller has not received messages from the ECM for 6 seconds.
Exception*	Always enabled.	Occurs when there is an issue from which the controller cannot recover. For example, EMI can cause the microcontroller to enter a bad state, or a software bug could cause the code to hang while triggering the watchdog. In these cases, the controller will reset and enter the failure state. *The name is configurable so it may not match what is shown here.
Failure To Stop	Disabled when ETS On Duration (Energize to Stop) is set to 0 seconds; otherwise, it is enabled. If used, ETS On Duration should be set to at least 2 to 3 seconds; otherwise, this failure may occur on a normal shutdown.	After ETS countdown is finished, if the speed was greater than 50 RPM (600 RPM for TG350/TG410 firmware 1.88 and above) for the previous 2 seconds, then the controller triggers this failure.



Failure Name	Enabled Condition(s)	Description
Load Imbalance	See the Load Imbalance section. AC Current feature.	Generator load imbalance. Excessive AC current on one or more of the three phases.
Low Air Pressure	Switched input set to “Air Pres. Fail” function. See the Switched Inputs section. Triggered if switched input is active during starting.	Application specific.
Low Coolant Lvl	Switched input set to “Cool. Lvl Fail” function. See the Switched Inputs section. Triggered if switched input is active.	Low Coolant Level.
Low Hydraulic	Switched input set to “Hyd Pres. Fail” function. See the Switched Inputs section. Triggered if switched input is active during starting.	Refers to Low Hydraulic pressure usually. Application specific.
FILL DEF NOW	For electronics engines with a SCR (Selective Catalytic Reaction) emissions aftertreatment only. See J1939 section and J1939 Reference Manual.	The SCR tank needs to be refilled (aka urea tank). Engine may not start if this is not performed or may remain in "limp-home" mode. DEF stands for diesel exhaust fluid.

If Battle Mode (see Battle Mode in the [Switched Inputs](#) section) is active (‘Battle Running’ is displayed on the screen), the controller will not shut down on a failure and no failure information will be displayed on the screen. If Battle Mode is switched off, the controller will shut down on any failure that occurred when Battle Mode was active.

3.5 Events History

The following table lists all events, warnings, and failures than can appear in the controller’s events history. The events history is accessed in the menu under “Events History.”

Event Name	Event Type	Description
Power On	Event	The controller has powered on.
Auto Enabled	Event	The controller has entered Auto Mode. The controller is waiting for a manual or automatic start condition such as a remote start / stop command.
Off Enabled	Event	The controller has entered Off Mode (Not in Auto is displayed on screen). Automatic starting is disabled.
Manual Start	Event	A user has pressed the RUN button on the controller.
Start Cooldown	Event	The controller has entered cooldown. Cooldown has to be enabled under Timers > Engine Logic.



Event Name	Event Type	Description
Remote Start	Event	A switched input remote start has been triggered. The controller will start.
Remote Stop	Event	A switched input remote stop has been triggered. The controller will stop.
Emergency Stop	Event	The switched input Emergency Stop has been triggered. The controller has performed an emergency shutdown, skipping cooldown.
Start Charging	Event	The controller has auto started because of a low starter battery condition. The low battery restart has to be enabled under Sensors > Battery.
Stop Charging	Event	The controller has run for the programmed amount of time to recharge the starter battery and is shutting down.
Service Required	Event	The controller requires maintenance. This has to be enabled under Timers > Maintenance. Also, after maintenance is performed, the tech has to reset the maintenance counter by going to Timers > Maintenance > Reset Counter and selecting "Yes."
Reset Defaults	Event	The controller has loaded default settings. This could have been because the user initiated a factory reset from the RapidCore software or because the controller memory has become corrupt. The controller will need to be programmed with the proper settings if applicable.
Service Complete	Event	The tech has performed service on the engine/generator and has reset the maintenance counter as mentioned in "Service Required" above.
Exerciser Bypass	Event	The exerciser, if enabled under Timers > Exerciser, has been skipped. This could happen if the controller was otherwise running or powered off when an exerciser was scheduled to be performed.
Start Exercise	Event	The controller has auto started to perform an exercise.
Stop Exercise	Event	The controller has run for the programmed exercise and is now shutting down.
Log Cleared	Event	The controller Events History has been cleared either from user action (via the RapidCore software) or because the controller memory was corrupt.
Modbus Start	Event	The controller has auto started from a start command sent to its RS485 Modbus port.
Modbus Stop	Event	The controller has auto stopped from a stop command sent to its RS485 Modbus port.
Genset Disable	Event	Applies to the Kubota electronic engine. Level 3 shutdown has occurred.
Engine Started	Event	The engine has successfully started and entered the Run Mode.
J1939 Remote	Event	The controller has auto started due to a command sent over its CAN J1939 port.



Event Name	Event Type	Description
Idle Speed	Event	The controller has entered Idle Mode either from the idle switched input, the warmup or cooldown idle feature under Engine Logic, or for some other reason. Under speed, under frequency, and under voltage warnings and failures are disabled.
Rated Speed	Event	The controller has exited Idle Mode and has gone back into normal running.
Sensor 1 Run	Event	The controller has auto started due to an Auxiliary Sensor 1 “start on low” or “start on high” request.
Sensor 2 Run	Event	The controller has auto started due to an Auxiliary Sensor 2 “start on low” or “start on high” request.
Sensor 1 Stop	Event	The controller has shut down due to an Auxiliary Sensor 1 “start on low” or “start on high” stop request.
Sensor 2 Stop	Event	The controller has shut down due to an Auxiliary Sensor 2 “start on low” or “start on high” stop request.
Switch Start	Event	A controller start was triggered by the momentary start switched input.
Switch Stop	Event	A controller stop was triggered by the momentary stop switched input.
Regen Inhibited	Event	Electronic engines with a Diesel Particulate Filter (DPF) only. The user requested that the automatic regeneration of the DPF be disabled.
Force Regen	Event	Electronic engines with a Diesel Particulate Filter (DPF) only. The user requested a manual regeneration of the DPF.
Auto Regen	Event	Electronic engines with a Diesel Particulate Filter (DPF) only. The engine ECM has performed an automatic regeneration of the DPF.
Sensor 3 Run	Event	The controller has auto started due to an Auxiliary Sensor 3 “start on low” or “start on high” request.
Sensor 4 Run	Event	The controller has auto started due to an Auxiliary Sensor 4 “start on low” or “start on high” request.
Sensor 3 Stop	Event	The controller has shut down due to an Auxiliary Sensor 3 “start on low” or “start on high” stop request.
Sensor 4 Stop	Event	The controller has shut down due to an Auxiliary Sensor 4 “start on low” or “start on high” stop request.
Long Time Start	Event	A user has started the controller using the RUN button and the long time run feature is enabled under Timers > Long Time Run. The controller will run for the duration specified under “Long Time Run” and then automatically shut down.
Scheduler Start	Event	The controller has auto started due to a daily schedule set up in Timers > Week Scheduler.
Start Cancelled	Event	A daily scheduler was cancelled either because the controller was not in Auto Mode, or a start request was ignored. A start request being ignored is an internal error and should not occur.



Event Name	Event Type	Description
J1939 Start	Event	Controller started from J1939 using the second J1939 start/stop method. Refer to the J1939 Reference Manual for more information. This is often used by telemetry devices to start/stop the controller.
Crank Failed	Warning	The controller has turned its crank output but has failed to detect that the engine is running. After crank rest (if programmed under Timers > Engine Logic) it will try again.
Low Batt InCrank	Warning	During cranking the battery was lower than normal. The level is set under Sensors > Battery.
Charger Fault	Warning	Indicates a battery charger issue. The controller has a battery charger fault switched input. This is used to indicate to the controller that the charger has a fault.
High Fuel Level	Warning	The fuel level has risen above the high fuel level warning threshold set under Sensors > Fuel Level. Potential over fueling issue.
Under Voltage	Warning	The generator AC voltage has fallen below the under voltage warning setpoint set under AC Monitor > Genset Voltage. Possible issue with the voltage regulator or speed governor on the engine.
Under Speed	Warning	The generator speed has fallen below the under speed warning setpoint set under Sensors > Engine Speed.
Over Speed	Warning	The generator speed has risen above the over speed warning setpoint set under Sensors > Engine Speed.
High Engine Temp	Warning	The engine temperature has risen above the high engine temperature warning under Sensors > Engine Temp.
Low Oil Pressure	Warning	The oil pressure has fallen below the low oil pressure warning setpoint under Sensor > Oil Pressure.
Low Fuel Level	Warning	The fuel level has fallen below the low fuel level warning setpoint under Sensors > Fuel Level.
False Restart	Warning	After going into the Run Mode, the controller has determined that the engine has not started after all and will attempt to do another crank attempt. The fault restart feature under Engine Logic > Timers has to be enabled.
Breaker Tripped	Warning	The “Breaker Trip” switched output has been activated. This output is used to control the generator breaker.
Over Current	Warning	The generator AC current has risen above the over current warning setpoint under AC Monitor > O.C. Protection > Basic Alarm.
Fuel In Basin	Warning	The “fuel in basin” switched input has been triggered. This indicates there has been a leak in the fuel tank.
Low Battery	Warning	The main starter battery (the battery from which the controller is powered) voltage has fallen below the low battery warning setpoint under Sensors > Battery.



Event Name	Event Type	Description
High Battery	Warning	The main starter battery (the battery from which the controller is powered) voltage has risen above the high battery warning setpoint under Sensors > Battery.
Low Engine Temp	Warning	The engine temperature has fallen below the low engine temperature warning setpoint set under Sensors > Engine Temp. > Setpoints.
Battle Running	Warning	The “Battle Mode” switched input has been triggered. The controller will not shut down on any failures. All failures will be ignored.
Under Frequency	Warning	The generator AC frequency has fallen below the under frequency warning setpoint set under AC Monitor > Genset Freq. > Setpoints.
Over Frequency	Warning	The generator AC frequency has risen above the over frequency warning setpoint set under AC Monitor > Genset Freq. > Setpoints.
Load Imbalance	Warning	The generator load is imbalanced between the A, B, and C phases. This has to be enabled under AC Monitor > O.C. Protection > Imbalance Mode.
Over Voltage	Warning	The generator AC voltage has risen above the over voltage warning setpoint set under AC Monitor > Genset Voltage. Possible issue with the voltage regulator or speed governor on the engine.
High Fuel Temp	Warning	Doosan G2 electronic engine high fuel temperature warning. This warning comes from the engine ECM over CAN J1939.
Hi Exhaust Temp	Warning	Doosan G2 electronic engine high turbine exhaust temperature. This warning comes from the engine ECM over CAN J1939.
Failed To Stop	Failure	The controller shut down the engine -- by turning off the Fuel output and (if enabled) by turning on the Energize-To-Stop output -- but the engine speed did not go to zero after the energize to stop time (under Timers > Engine Logic).
Breaker Failed	Failure	The “Breaker Trip” switched output failed to turn off the breaker. This is triggered if the AC Current is still above 10% of the rated current setpoint. The “breaker trip” failure has to be enabled under AC Monitor > O.C. Protection > Brk Trip Fail.
Load Imbalance	Failure	The generator load is imbalanced between the A, B, and C phases. This has to be enabled under AC Monitor > O.C. Protection > Imbalance Mode with the mode set to “Shutdown Trip.”
Over Current	Failure	The generator AC current has risen above the over current failure setpoint set under AC Monitor > O.C. Protection > Basic Alarm.
ECM Shutdown	Failure	Electronic engines only. CAN J1939 DM1 stop lamp is active; the ECM has shut down the engine.
High Engine Temp	Failure	Engine temperature has risen above the high engine temperature failure setpoint set under Sensors > Engine Temp.
Low Oil Pressure	Failure	Engine oil pressure has fallen below the low oil pressure failure setpoint set under Sensors > Oil Pressure.



Event Name	Event Type	Description
Under Speed	Failure	Engine speed has fallen below the under speed failure setpoint set under Sensors > Engine Speed.
Over Speed	Failure	Engine speed has risen above the over speed failure setpoint set under Sensors > Engine Speed.
Low Fuel Level	Failure	The fuel level has fallen below the low fuel level failure setpoint under Sensors > Fuel Level.
Low Battery	Failure	The main starter battery (the battery from which the controller is powered) voltage has fallen below the low battery failure setpoint set under Sensors > Battery.
Low Coolant Lvl	Failure	The “Low Coolant Level” switched input is active indicating low coolant level failure.
Over Crank	Failure	The controller exhausted the crank attempts (specified in Timers > Engine Logic > Crank Attempts) and could not start the engine.
Over Voltage	Failure	The generator AC voltage has risen above the over voltage failure setpoint set under AC Monitor > Genset Voltage > Setpoints.
Under Voltage	Failure	The generator AC voltage has fallen below the under voltage failure setpoint set under AC Monitor > Genset Voltage > Setpoints.
Regen Needed	Failure	For electronic engines with a diesel particulate filter (DPF) only. The user must perform a regeneration before running the engine further. Continuing to ignore this message could result in the DPF being damaged and requiring replacement.
Low Air Pressure	Failure	The “Air Press. Fail” switched input is active. Indicates a low air pressure failure condition.
Low Hydraulic	Failure	The “Hyd Pres. Fail” switched input is active. Indicates a low hydraulic pressure failure condition.
High Battery	Failure	The main starter battery (the battery from which the controller is powered) voltage has risen above the high battery failure setpoint set under Sensors > Battery.
Loss Of ECM Comm	Failure	For electronic engines only. The “Loss of ECM” under J1939 must be enabled. The controller has not detected engine speed, oil pressure, or engine temperature on its CAN J1939 port.
Under Frequency	Failure	The generator AC frequency has fallen below the under frequency failure setpoint set under AC Monitor > Genset Freq. > Setpoints.
Over Frequency	Failure	The generator AC frequency has risen above the over frequency failure setpoint set under AC Monitor > Genset Freq. > Setpoints.
DPF SRVC REQ'D!	Failure	For electronic engines with a diesel particulate filter (DPF) only. Service the DPF ASAP. Damage to the DPF is possible if the engine is run.



Event Name	Event Type	Description
SERVICE DPF!!!	Failure	For electronic engines with a diesel particulate filter (DPF) only. Service the DFP ASAP. Damage to the DPF is likely if the engine is run.
Calibration Fail	Failure	Doosan G2 electronic engine only. Contact Doosan for more information.
High Fuel Temp	Failure	Doosan G2 electronic engine high fuel temperature failure. This failure comes from the engine ECM over CAN J1939.
Hi Exhaust Temp	Failure	Doosan G2 electronic engine high turbine exhaust temperature failure. This failure comes from the engine ECM over CAN J1939.
FILL DEF NOW	Failure	For electronics engines with a SCR (Selective Catalytic Reaction) device only. The SCR needs to be refilled. Engine may not start if this is not performed, or it may remain in "limp-home" mode. DEF stands for diesel exhaust fluid.
Engine Stall	Failure	The controller is in the Run Mode and the engine speed has fallen below the crank disconnect speed. The engine stall must be enabled under Timers > Engine Logic.



4 Settings

The following section relates to settings that can be changed to alter the way the controller performs its functions. Read and review these sections carefully to ensure your settings are set correctly for your engine.

4.1 Operator Setup

The following settings are used to change the way the user interacts with the controller. They are not password protected and can be changed by anyone from the front panel.

Name	Range	Default Setting	Description
Lamp Test	-----	-----	Performs a lamp test on the LEDs when selected.
Display > LCD Reverse	-----	-----	Reverses the white and black pixels when selected.
Display > LCD Contrast	5 ~ 95%	50%	Changes the contrast of the LCD.
Display > Page Scroll	1 ~ 10 s	5 s	Amount of time between each auto scroll of the parameter pages.
Display > Message Pop-Up	1 ~ 10 s	2 s	Amount of time each message is displayed on the screen before displaying next message in the buffer.
Display > DPF/DEF Display Time	0 ~ 10 s	2 s	See DPF/DEF aftertreatment in the J1939 Reference Manual for more information.
Display > LCD Backlight Timeout	10 ~ 600 s	600 s	Amount of time the LCD Backlight stays on after button activity stops.
Date / Time > Date Change	1 ~ 31 days 1 ~ 12 months 2000 ~ 2099 yr	-----	Sets the date.
Date / Time > Time Change	0 ~ 23 hr 0 ~ 59 min 0 ~ 59 s	-----	Sets the time.
Date / Time > Daylight Saving	Enable Disable	Enable	Turns Daylight Saving Time on or off. This applies to North America only. Disable for other locations.
Units > Temperature Unit	Fahrenheit or Celsius	Fahrenheit	Selects the temperature display format.
Units > Pressure Unit	PSI or kPa	PSI	Selects the oil pressure display format.



Name	Range	Default Setting	Description
Run from OFF > RUN from OFF	Enable Disable	Enable	When enabled, allows a user to start the engine using the RUN button while in the Off Mode. When disabled, the controller must be placed in Auto Mode before the RUN button can start the engine.

4.2 Switched Inputs

The controller has five switched inputs which cause the controller to perform a function when activated. The following are the default settings.

Default Settings

Switched Input	Default Value
Switched Input A	Emergency Stop
Switched Input B	Start / Stop
Switched Input C	Disable
Switched Input D	Disable
Switched Input E	Disable



Switched I/O > Switched IN X:

Name	Range	Description
Function	[Menu] See below.	The function that the switched input performs when active.
Active Mode	[Menu] See below.	Determines the operating conditions under which the switched input can be active. Multiple selections are allowed.
Trigger	[Menu] See below.	The state of the input determining if it is active or inactive.

Switched I/O > Switched IN X > Function:

Name	Active Mode	Description
Disabled	N/A	Input is disabled and has no function.
Start / Stop	Auto, Running	Starts the engine when active, stops the engine when deactivated. It is recommended that the Trigger mode be set to Close +BAT for better noise tolerance. If Trigger mode is set to "Open" or "Close +BAT/GND", the start/stop input will act like a momentary input. A pulse of 2 to 4 seconds will start controller. Another pulse of 2 to 4 seconds is required to stop the controller. If the input is just turned off, the controller will continue to run.



Name	Active Mode	Description
Emergency Stop	Global	<p>When active, shuts down the engine, displays Emergency Stop, and prevents leaving the OFF Mode.</p> <div style="border: 1px solid black; padding: 5px; margin-bottom: 10px;">  <p>CAUTION</p> <p>THIS SHOULD ONLY BE USED FOR THE EMERGENCY STOP INDICATION ON THE CONTROLLER. THE INSTALLER MUST PROVIDE AN INDEPENDENT MEANS TO SHUT DOWN THE ENGINE FROM THE EMERGENCY STOP BUTTON SUCH AS CUTTING OFF FUEL. SEE THE TYPICAL WIRING DIAGRAMS FOR AN EXAMPLE ON HOW TO WIRE UP THE EMERGENCY STOP.</p> </div> <div style="border: 1px solid black; padding: 5px;">  <p>ATTENTION</p> <p>CELA NE DOIT ETRE UTILISE QUE POUR L'INDICATION D'ARRET D'URGENCE SUR LE CONTROLEUR. L'INSTALLATEUR DOIT PREVOIR UN MOYEN INDEPENDANT D'ARRETER LE MOTEUR A PARTIR DU BOUTON D'ARRET D'URGENCE, PAR EXEMPLE EN COUPANT LE CARBURANT. VOIR LES SCHEMAS DE CABLAGE TYPES, POUR UN EXEMPLE DE CABLAGE DE L'ARRET D'URGENCE.</p> </div>
Idle Mode	Running	See the Idle section under Engine Logic for more information.
Voltage Select 1	Auto	Used for changing the system AC voltage configuration. See AC Voltage Select for more information.
Voltage Select 2	Auto	
Charger Fault (Battery Charger Fault)	Global	Controller displays “Charger Fault” warning when active.
Mom. Start (Momentary Start)	Auto	Starts or stops the engine when momentarily active for at least 2 seconds. These inputs allow the user to wire separate inputs for start and stop or to use a push button instead of a toggle switch. Momentary stop will only stop the controller when the reason for start was “momentary start.” It will not stop if the front panel RUN button was used to start the engine.
Mom. Stop (Momentary Stop)	Running	
Configurable Warning 1	Configurable	Controller displays a warning or failure with configurable text when active. In the case of the configurable failures, a shutdown is also performed.
Configurable Warning 2	Configurable	
Configurable Failure 1	Configurable	The RapidCore Configurator Software must be used to change the text.



Name	Active Mode	Description
Configurable Failure 2	Configurable	The settings under Timers > Trigger Delays > Config Inputs and Timers > Trigger Delays > Config Fail 3 can be set to control the amount of time the input has to be active in order to trigger.
Configurable Failure 3	Configurable	
Air Press. Fail (Air Pressure Failure)	Cranking	Controller displays 'Low Air Pressure' and shuts down engine when active.
Hyd Pres. Fail (Low Hydraulic Pressure Failure)	Cranking	Controller displays 'Hydraulic Pressure Failure' and shuts down engine when active.
Oil Pres Warn (Low Oil Pressure Warning)	Running	Controller displays 'Oil Pressure Warning' when active.
Cool. Lvl Fail (Low Coolant Level Failure)	Global	Controller displays 'Low Coolant Lvl' and shuts down engine when active.
High Fuel Warning	Global	Controller displays 'High Fuel Level' warning when active.
Lamp Test	Global	Controller performs lamp test when active. If the controller is in the Failure Mode, the LED will remain red. The only indication that the lamp test is active is the LED indicator will alternate between the green and red colors. The LED goes back to its original state when the switched input is no longer active.
Fuel In Basin	Global	Controller displays 'Fuel In Basin' warning when active.
Battle Mode	After Cranking	Controller ignores all warnings and failures when active. Displays 'Battle Running' when active. If a failure occurs during Battle Mode, it is 'latched' and the engine will shut down on failure when the controller leaves Battle Mode.
Start Inhibit	Global	Controller ignores all start commands, and the engine cannot start when active. Once Start Inhibit becomes inactive, starting is enabled again. If the engine is running, activating this input will shut down the engine and place the controller in Auto Mode.
RPM Switch (Primary RPM / 60 Hz - Secondary RPM / 50 Hz Select)	Auto	Used for changing between Primary and Secondary RPM for an engine or 50 Hz / 60 Hz for a generator. See RPM / Frequency Select for more information.
ECM Preheat (ECM Preheat Signal)	Cranking (during the Preheat countdown only)	Controls preheating using a switched input. See Switched Input in the Preheat Mode section.



Name	Active Mode	Description
Remote Reset	Global	<p>Allows the controller to be reset from a Failure Mode.</p> <ul style="list-style-type: none"> • Momentary action for 3-5 seconds in Failure Mode will place the controller in Off Mode • Momentary action for 3-5 seconds in Off Mode will place the controller in Auto Mode • Momentary action for 3-5 seconds Run Mode will place the controller in Auto Mode. Cool-down is skipped.

	CAUTION
	MORE THAN ONE ACTIVE MODE CAN BE SELECTED.

	ATTENTION
	IL EST POSSIBLE DE SELECTIONNER PLUS D'UN ACTIVE MODE (MODE ACTIF).

The active mode is only configurable if the Function menu is set to one of the configurable switched input functions. It is fixed for all other functions.

Switched I/O > Switched IN X > Trigger:

Name	Description
Close +BAT	Input is active when +Battery is present at the terminal.
Close GND	Input is active when Ground is present at the terminal.
Close +BAT/GND	Input is active when either +Battery or Ground is present at the terminal.
Open	Input is active when neither +Battery nor Ground is present at the terminal.

	CAUTION
	WHEN RUNNING WIRES OVER LONG DISTANCES (OVER 20 FT / 6.1 M), IT IS RECOMMENDED THAT THE +BATTERY BE USED AS THE TRIGGER METHOD.

	ATTENTION
	LORSQUE VOUS FAITES PASSER DES FILS SUR DE LONGUES DISTANCES (AU DELA DE 6 M), IL EST RECOMMANDE D'UTILISER +BATTERIE COMME METHODE DE DECLENCHEMENT.

4.2.1 Configurable Inputs

These inputs are used to create custom warnings and failures. Using the RapidCore Configurator Software, you can change the text displayed when the warning or failure occurs. If you select one of these inputs without changing the text, it will default to 'Config Warn X' and 'Config Fail X'.



There are also timers associated with the configurable inputs which can be found in the menu under Timers > Trigger Delays > Config Inputs and Config Fail 3. These timers change the amount of time the input has to be active before the controller registers the warning or failure.

	CAUTION
	IF THE SWITCHED INPUT BECOMES INACTIVE BEFORE THE TRIGGER DELAY TIME EXPIRES, THE WARNING OR FAILURE WILL NOT OCCUR.

	ATTENTION
	SI L'ENTREE COMMUTEE DEVIENT INACTIVE AVANT L'EXPIRATION DU DELAI DE DECLENCHEMENT, L'AVERTISSEMENT OU LA PANNE NE SE PRODUIRA PAS.

Example: The user wants a pump to turn on 30 seconds after a high water level switch is tripped and remain on until the level switch turns off.

The level switch is connected to Switched Input C and closes to ground when the water level is too high. The words 'Water Pumping' are also required to be displayed on the controller's LCD screen. The pump is connected to a slave relay which is controlled by Switched Output D on the controller.

Relevant Settings

Setting	Value
Switched Input C > Function	Configurable Warning 1
Switched Input C > Active Mode	Global
Switched Input C > Trigger	Close GND
Configurable Warning 1 Custom Text	Water Pumping
Switched Output D > Warnings	Configurable Warning 1

4.3 Switched Outputs

The controller has switched outputs that are turned on under certain conditions to perform a function. The outputs turn on to +Battery voltage to drive the load when active. The following items are the available functions for switched outputs.

	WARNING
	SWITCHED OUTPUTS HAVE A FLOATING VOLTAGE OF APPROXIMATELY 8 V WHEN OFF. IF USING THE OUTPUTS FOR DIGITAL LOGIC, IT WILL BE NECESSARY TO PUT A PULL-DOWN RESISTOR (2.2 KΩ, 1 WATT) FROM THE OUTPUT TO GROUND TO ENSURE A LOW LOGIC LEVEL WHEN OUTPUT IS OFF.



	AVERTISSEMENT
	<p>LES SORTIES COMMUTEES PRESENTENT UNE TENSION FLOTTANTE D'ENVIRON 8 V LORSQU'ELLES SONT OFF (INACTIVES). SI VOUS SOUHAITEZ UTILISER LES SORTIES COMME SIGNAUX LOGIQUES NUMERIQUES, IL FAUT INSTALLER UNE RESISTANCE PULL-DOWN (2,2 KΩ, 1 W) ENTRE LA SORTIE CONCERNEE ET LA MASSE, POUR ASSURER UN NIVEAU LOGIQUE BAS QUAND LA SORTIE EST OFF.</p>

Default Settings

Switched Output	Default Setting
Switched Output A	Fuel Output
Switched Output B	Disable
Switched Output C	Crank Output
Switched Output D	Disable
Switched Output E	Disable
Switched Output F	Disable

Event Functions

Name	Active Mode	Description
Fuel	Cranking, Running	Active during cranking and running to supply fuel to engine.
Crank	Cranking	Active during cranking to start the engine.
Pull Coil	Cranking	See Pull and Hold Coil section for more information.
LCD Backlight	Global	Active when LCD Backlight is active.
Voltage Regulator	Running	Active when engine is starting/running and is not in Idle Mode.
ETS (Energize to Stop)	ETS Timer	Active during Energize to Stop timer. See 74 under Timers > Engine Logic for more details.
Off Mode (Not In Auto)	Off	Active when the controller is in the Off Mode.
Idle Mode	Idle Mode	Active when the controller is in Idle Mode. For example, when the idle switched input is active or during warmup and cooldown if warmup idle and cooldown idle settings under Timers > Engine Logic are enabled.
Battle Mode	Battle Mode	Active when Battle Mode switched input is active.
System OK (System Ready)	Auto, Run	Active when the controller is in the Auto and Run Modes and no warnings or failures are present.
Delay to Start	Delay to Start Timer	Active when the Delay to Start timer is active.



Name	Active Mode	Description
Glowplug	Preheat, Midheat, Postheat	Active during the Preheat, Midheat and Postheat timers.
Warmup	Warmup Timer	Active in Run Mode after Warmup Timer has expired. Is not active in the cooling down state or other states. Typically used to apply load to the engine only after it has warmed up and to remove the load on cooldown.
Cooldown	Cooldown Timer	Active when Cooldown Timer is active.
Engine Running	Running	Active after crank success.
Exercising	Exercise Timer	Active during the engine exercising cycle.
Batt. Recharge (Battery Recharge)	Battery Recharge Timer	Active during the battery recharge cycle.
Maintenance (Maintenance Required)	Global	Active when Maintenance timer has expired. If the timer has expired when the controller is in the Run Mode, the output does not turn on until the controller enters the Off or Auto Mode. See the Maintenance section.
LowBat InCrank (Low Battery During Cranking)	Cranking	Active when Low Battery During Cranking warning is displayed.
Aux Sensor 1	Auxiliary Settings Dependent	Active dependent upon settings in the Auxiliary Sensors section.
Aux Sensor 2		
Aux Sensor 3		
Aux Sensor 4		
Force Regen	User Controlled	When user triggers a Force Regeneration, output is active for 20 seconds then switches off.
Regen Inhibit	User Controlled	When user triggers a Regeneration Inhibit, output is active for 20 seconds then switches off.
Common Failure	Any Failure	Active when any failure occurs.
RPM Increment	Running	Output is used to trigger inputs on an ECM to control speed. See Front Panel Speed Control section for more information.
RPM Decrement	Running	Output is used to trigger inputs on an ECM to control speed. See Front Panel Speed Control section for more information.
DEF Fluid Pump	Running	Active when DEF Fluid Level falls below the DEF Low Level and stays active until the level rises above the DEF High Level. See CANbus (J1939) section for more information.



Name	Active Mode	Description
Genset Disable	Global	Disables the generator during a stationary Regen on Kubota engines (see Aftertreatment in the J1939 Reference Manual) or also during an engine idle condition from the idle switched input. Automatic idle is ignored. If the generator voltage is not below the under voltage setpoint in 10 seconds, the controller will shut down the engine on “Generator Disable Failure.”
Dummy Load	Running	Output is controlled by the Dummy Load feature.
Breaker Trip	Running	Output is controlled by the Basic Alarms , IDMT and Load Imbalance features. The Breaker Trip only reacts to over current faults; it does not activate for other failures.
Auto Idle	Warm-up, Cooldown	Active at the start of delay to start until the end of warm-up if warmup idle is enabled. Also active during cooldown if cooldown idle is enabled. See Warm-up Idle and Cooldown Idle in Engine Logic . This output does not react to the Idle switched input.
RPM Output	Running	Refer to the RPM Output feature under Sensors > Engine Speed for more information.
Amb Temp Out	Running	Used by the J1939 Ambient Air Temperature Control feature. Refer to the J1939 Reference Manual for more details.

Warning Functions

Functions			
Low Engine Temperature	High Engine Temperature	Low Oil Pressure	Under Speed
Over Speed	Low Fuel Level	High Fuel Level	Low Battery Voltage
High Battery Voltage	Under Frequency	Over Frequency	AC Under Voltage
AC Over Voltage	Over Current	Fuel In Basin	Battery Charger Fault
Configurable Warning 1	Configurable Warning 2	Auxiliary Sensor 1	Auxiliary Sensor 2
Auxiliary Sensor 3	Auxiliary Sensor 4		
Name	Active Mode	Description	
Load Imbalance	Running	AC current phases do not match. (Load Imbalance)	
DTC Received (DTC/MIL)	Running	Active when controller receives a DM1 from the ECM.	



Failure Functions

Functions			
Overcrank	Engine Failed to Stop	DM1 Stop Lamp	High Engine Temperature
Low Oil Pressure	Low Fuel Level	Under Speed	Over Speed
Low Battery Voltage	High Battery Voltage	Low Coolant Level	Low Air Pressure
Low Hydraulic Pressure	Under Frequency	Over Frequency	AC Under Voltage
AC Over Voltage	Over Current (TG410 only)	ECM Communication Failure	Configurable Failure 1
Configurable Failure 2	Configurable Failure 3	Auxiliary Sensor 1	Auxiliary Sensor 2
Auxiliary Sensor 3	Auxiliary Sensor 4		
Name	Active Mode	Description	
Load Imbalance	Running	AC current phases do not match. (Load Imbalance)	
Exception Fault*	All	When the controller encounters an unhandled exception or lockup (watchdog triggered), it will reset and enter the Failure Mode as an exception fault. *The name of this fault is configurable from the Configurator Software.	

4.3.1 Group Outputs

Group functions have been designed to allow multiple output functions to be bundled together and assigned to a single switched output pin. The definition of a group output follows.

When any of the functions in a group is active (OR logic), the assigned switched output will be active.

Group Functions

Name	Active Mode	Description
Group #1	Group Dependent	Must be set from RapidCore Configurator software.
Group #2	Group Dependent	Must be set from RapidCore Configurator software.
Group #3	Group Dependent	Must be set from RapidCore Configurator software.
Group #4	Group Dependent	Must be set from RapidCore Configurator software.

Example: Low AC Frequency, High AC Frequency are bundled in 'Group #1' and assigned to Switched Output D. This output is connected to an external indicator lamp labeled 'AC Frequency Warnings', allowing one output to indicate there is a warning with the AC frequency. The following table shows the output state based on the Warnings status.

Low AC Frequency Warning	High AC Frequency Warning	Switched Output State
Inactive	Inactive	OFF
Inactive	Active	ON



Low AC Frequency Warning	High AC Frequency Warning	Switched Output State
Active	Inactive	ON
Active	Active	ON

4.3.2 Pull and Hold Coil

On some engine systems the fuel pump has two coils. This is because the initial power-on of the fuel solenoid requires substantial current (Pull Coil), but only needs a small amount of current to hold it in place (Hold Coil).

1. Hold Coil (Fuel) is energized.
2. Pull Coil is energized for the first 1.6 to 1.8 seconds of preheat. If preheat is disabled, the pull coil is energized at the beginning of cranking; the crank output turned off for that time period.
3. This is repeated for each crank attempt.

Configuring a switched output to Pull Coil automatically configures the engine logic necessary for a Pull Coil system.

Note: The pull coil feature does not operate when the fuel output is activated by the Auto Power ECM feature or when requesting stored DTCs (DM2 codes). See the [CANbus \(J1939\)](#) section for more information on these features.

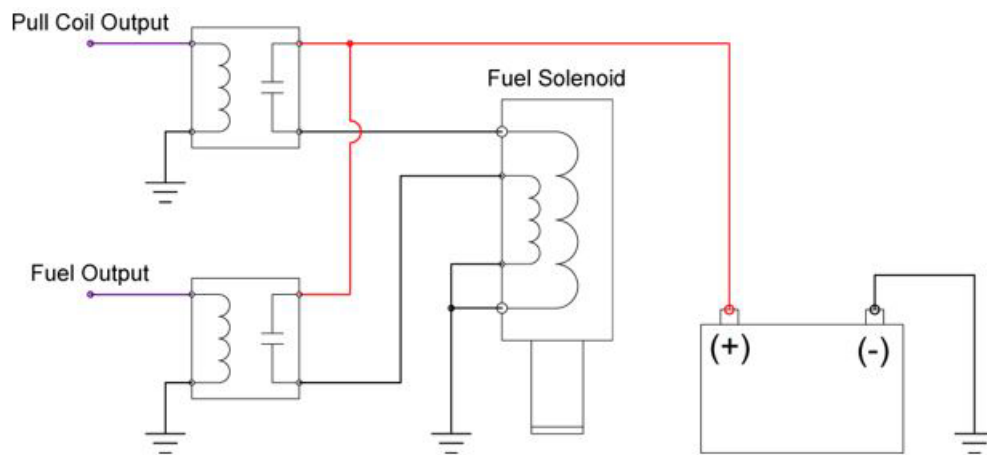

Pull Coil Wiring Example



4.4 Sensors

The controller has four sensor inputs which can be connected to a variety of different sensors/switches depending on the input. See the [Terminal Descriptions](#) section for more information regarding the sensor types supported.

To configure the behavior of these sensor inputs, the user assigns the sensor input to one of the following seven sensor functions:

- Engine Temperature
- Oil Pressure
- Fuel Level
- Auxiliary Sensor 1
- Auxiliary Sensor 2
- Auxiliary Sensor 3
- Auxiliary Sensor 4

Note that there are more sensor functions than sensor inputs as the Auxiliary Sensors can be assigned the same sensor input as the other sensor functions.

- The Engine Temperature, Oil Pressure, and Fuel Level functions are mostly fixed in functionality but the [Auxiliary Sensors](#) can be configured to perform specific shutdowns or special functions (for example, starting engine on low temperature)
- The Engine Temperature, Oil Pressure, and Fuel Level functions can be set to work with a switch or a sender/sensor, but the Auxiliary sensors can only work with a sender

Note: The engine speed and battery level are built in and do not need to be assigned to a pin.

4.4.1 Engine Temperature

Use the following settings' configurations to allow the controller to read and interpret data from the engine temperature sensor or switch.

(Sensors > Engine Temp. menu)

Name	Range	Default Settings	Description
Signal Source	Port A Port B Port C Port D J1939 Bus*	Port A	The sensor input pin where the engine temperature switch or sender is attached. *Engine temperature is obtained from the engine controller (ECM) using the CANbus communication port and J1939 protocol.



Name	Range	Default Settings	Description
Sensor Type	DAT DAH* VDO 250F* (custom sender)** Close = Warning+ Open = Warning+ Close = Failure+ Open = Failure+	DAT DAH	<p>Select the sender that is connected to the Signal Source above. If using a switch, select the action that should occur when the switch is active.</p> <p>*These are preprogrammed into the controller and cannot be changed.</p> <ul style="list-style-type: none"> - DAT DAH supports all Datcon type DAH (high range) temperature sensors such as 02022-00 - VDO 250F supports the VDO 323-420 or equivalent temperature sensor <p>DAT DAH and VDO 250F can only be used if the Signal Source is set to Port A, C or D. To use on other ports, store as a custom sender table using the RapidCore Configurator software.</p> <p>**A custom table can be created using the RapidCore Configurator Software. The text (custom sender) will be replaced with the custom text you choose when creating the sender.</p> <p>+The switch must close to ground.</p>
Trim Offset	-50.0 ~ 50.0 °F (-27.8 ~ 27.8 °C)	0.0 °F	Calibrate a sensor by using the offset to correct errors. Only applies if Sensor Type has been set to a sender.
Setpoints > Bypass Time	0 ~ 90 s	30 s	Amount of time to bypass warnings and failures after engine has started.
Setpoints > Low Warn (Low Warning)	Disabled 32 ~ 200 °F (0 ~ 93.3 °C)	Disabled	Reading at which a “Low Engine Temp” warning occurs. Displays ‘Low Engine Temp’ on the screen. Only applies if Sensor Type has been set to a sender. Monitored globally including Off and Auto Mode.
Setpoints > High Warn (High Warning)	Disabled 50 ~ 300°F (10 ~ 148.9 °C)	200 °F	Reading at which a “High Engine Temp” warning occurs. Only applies if Sensor Type has been set to a sender. Only monitored in the Run Mode.
Setpoints > High Fail (High Failure)	Disabled 50 ~ 300°F (10 ~ 148.9 °C)	220 °F	Reading at which a “High Engine Temp” failure occurs. Only applies if Sensor Type has been set to a sender. Only monitored in the Run Mode.

Note: All temperature settings are entered in terms of Fahrenheit.



4.4.2 Oil Pressure

Use the following settings' configurations to allow the controller to read and interpret data from the oil pressure sensor or switch.

Name	Range	Default Settings	Description
Signal Source	Port A Port B Port C Port D J1939 Bus*	Port B	The sensor input pin where the oil pressure switch or sender is attached. *Oil pressure is obtained from the engine controller (ECM) using the CANbus communication port and J1939 protocol.
Sensor Type	DAT 100P/R240* VDO 150P/R180* (custom sender)** Close = Warning ⁺ Open = Warning ⁺ Close = Failure ⁺ Open = Failure ⁺	DAT 100P/R240 (Stewart 279B-F)	Select the sender that is connected to the Signal Source above. If using a switch, select the action that should occur when the switch is active. *These are preprogrammed into the controller and cannot be changed. - DAT 100P/R240 supports the Stewart - Warner 279B-F and Datcon 2505-00 sender tables - VDO 150P/R180 supports the VDO 360-004 oil pressure sender DAT 100P/R240 and VDO 150P/R180 cannot be used on port A. To use on port A, store as a custom sender table using the RapidCore Configurator software. **A custom table created using RapidCore Configurator Software. The text (custom sender) will be replaced with the custom text you choose when creating the sender. ⁺ The switch must close to ground.
Trim Offset	-50.0 ~ 50.0 PSI (-344.7 ~ 344.7 kPa)	0 PSI	Calibrate a sensor by using the offset to correct errors. Only applies if Sensor Type has been set to a sender.
Setpoints > Bypass Time	0 ~ 90 s	30 s	Amount of time to bypass warnings and failures after engine has started.
Setpoints > Low Warning	Disabled 0.1 ~ 99.0 PSI (0.7 ~ 682.6 kPa)	20.0 PSI	Reading at which a "Low Oil Pressure" warning occurs. Only applies if Sensor Type has been set to a sender.
Setpoints > Low Failure	Disabled 0.1 ~ 99.0 PSI (0.7 ~ 682.6 kPa)	15.0 PSI	Reading at which a "Low Oil Pressure" failure occurs. Only applies if Sensor Type has been set to a sender.

Note: All pressure settings are entered in terms of PSI.



4.4.3 Fuel Level

Use the following settings' configurations to allow the controller to read and interpret data from the fuel level sensor.

Name	Range	Default Settings	Description
Signal Source	Disable Port A Port B Port C Port D	Disable	The sensor input pin where the fuel level switch or sender is attached
Sensor Type	DAT R/33-240* VDO R/0-180* (custom sender)** Close = Warning ⁺ Open = Warning ⁺ Close = Failure ⁺ Open = Failure ⁺	Close = Failure	<p>Select the sender that is connected to the Signal Source above. If using a switch, select the action that should occur when the switch is active.</p> <p>*These are preprogrammed into the controller and cannot be changed.</p> <ul style="list-style-type: none"> - DAT R/33-240 supports a Datcon fuel level sensor of the range 33 Ω to 180 Ω - VDO R/0-180 supports a VDO fuel level sensor of the range 0 Ω to 180 Ω <p>DAT R/33-240 and VDO R/0-180 cannot be used on port A. To use on port A, store as a custom sender table using the RapidCore Configurator software.</p> <p>**A custom table created using the RapidCore Configurator Software. The text (custom sender) will be replaced with the custom text you choose when creating the sender.</p> <p>⁺The switch must close to ground</p>
Trim Offset	-50.0 ~ 50.0%	0.0%	Calibrate a sensor by using the offset to correct errors. Only applies if Sensor Type has been set to a sender.
Setpoints > Bypass Time	0 ~ 90 s	30 s	Amount of time to bypass warnings and failures after engine has started.
Setpoints > Low Warning	Disabled 1 ~ 90%	25%	Reading at which a "Low Fuel Level" warning occurs. Only applies if Sensor Type has been set to a sender. Only monitored in the Run Mode.



Name	Range	Default Settings	Description
Setpoints > Low Failure	Disabled 1 ~ 90%	5%	Reading at which a “Low Fuel Level” failure occurs. Only applies if Sensor Type has been set to a sender. Only monitored in the Run Mode.
Setpoints > High Warning	Disabled 1 ~ 125%	Disabled	Reading at which a “High Fuel Level” warning occurs. Displays ‘High Fuel Level’ on the screen. Only applies if Sensor Type has been set to a sender. Monitored globally including Off and Auto Mode.

4.4.4 Engine Speed

Use the following settings’ configurations to allow the controller to read and interpret speed sensing data.

Name	Range	Default Settings	Description
Signal Source	J1939 Bus Mag Pickup Genset Voltage	Genset Voltage	The source for the engine speed signal. J1939 -- Engine speed is obtained over the engine CAN communication bus. Genset Voltage -- The AC Voltage connector phase A is used for engine speed. Mag Pickup -- A magnetic pickup, alternator output, or the distributor signal can be used to sense speed. Must use J6 pins 7 and 8. If using a distributor, a filter is often required. Contact Cattron at www.cattron.com for more information on using a distributor signal.
Speed Settings > Rated RPM	500 ~ 4000 RPM in 1 RPM increments	1800 RPM	Speed at which the engine runs under normal operating conditions. Warning and failure setpoints are calculated from this setting.
Speed Settings > Idle RPM	300 ~ 2000 RPM in 1 RPM increments	900 RPM	Speed at which the engine runs when it is idling.



Name	Range	Default Settings	Description
Speed Settings > Tooth Count	1 ~ 600	110	(only applies when Signal Source is set to Mag Pickup) Number of teeth on the flywheel. If the number of teeth is unknown, the following formula can be used. A multimeter must be used to measure the AC frequency (Frequency-In-Hz below) from the magnetic pickup. The speed (Speed-In-RPM below) must be known. $\text{Tooth-Count} = (\text{Frequency-In-Hz} * 60) / \text{Speed-In-RPM}$
Setpoints > Low Warn (Under Speed Warning)	20 ~ 99%	90%	Reading at which a warning occurs.
Setpoints > Low Fail (Under Speed Failure)	20 ~ 99%	85%	Reading at which a failure occurs.
Setpoints > High Warn (Over Speed Warning)	101 ~ 150%	110%	Reading at which a warning occurs.
Setpoints > High Fail (Over Speed Failure)	101 ~ 150%	115%	A over speed failure is triggered if the speed is above this threshold for 4 seconds.
RPM Control > Min Speed	500 ~ 4000 RPM in 1 RPM increments	600 RPM	Front Panel Speed Control Settings. See the Front Panel Speed Control section for more information on these settings.
RPM Control > Max Speed	500 ~ 4000 RPM in 1 RPM increments	2000 RPM	
RPM Control > Speed Bias	0 to 600 RPM in 1 RPM increments	30 RPM	
RPM Control > TSC1 RPM/s	Disabled 10 to 300 RPM in 10 RPM increments	200 RPM	
RPM Display	Blank AC Hertz Aux Sensor 1 Aux Sensor 2	AC Hertz	



Name	Range	Default Settings	Description
RPM Switch > Secondary (Secondary RPM / 50 Hz)	500 ~ 4000 RPM in 1 RPM increments	1500 RPM	The Rated RPM when the Secondary RPM / 50 Hz is selected. See RPM / Frequency Select section for more information.
RPM Switch > Primary (Primary RPM / 60 Hz)	500 ~ 4000 RPM in 1 RPM increments	1800 RPM	The Rated RPM when the Primary RPM / 60 Hz is selected. See RPM / Frequency Select section for more information.
RPM Output	See the RPM Output section for more information.		

Note: When using J1939 or Genset Voltage as a signal source, connections to the speed sensing terminals are not required.

IMPORTANT: When using Genset Voltage as a signal source, the voltage source must be connected to terminal A (J7-1). AC frequency is sensed on terminal A only.

	CAUTION
	<p>SPEED IS MONITORED AT THE START OF CRANKING. IF THERE IS SPEED DETECTED ABOVE THE CRANK DISCONNECT SETTING, THEN CRANKING AND IDLE ARE SKIPPED. THE SPEED IS NOT MONITORED DURING DELAY TO START OR PREHEAT AS THIS PROVIDES SOME DEGREE OF PROTECTION AGAINST SPURIOUS SIGNALS DUE TO NOISE. THE FUEL INPUT IS TURNED ON AT THE START OF PREHEAT AND OFTEN POWERS EXTERNAL EQUIPMENT THAT CAN CAUSE NOISE.</p>

	ATTENTION
	<p>LA VITESSE DE ROTATION EST CONTROLEE AVANT D'ENGAGER LE DEMARREUR. SI LA VITESSE DETECTEE EST SUPERIEURE A LA VITESSE DE DESENGAGEMENT DU DEMARREUR, LE DEMARRAGE ET LE RALENTI SONT IGNORES. LA VITESSE N'EST PAS CONTROLEE PENDANT LE DELAI DE DEMARRAGE OU DE PRECHAUFFAGE, AFIN D'ASSURER UNE CERTAINE PROTECTION CONTRE LES SIGNAUX PARASITES DUS AU BRUIT. L'ARRIVEE DE CARBURANT EST ACTIVEE AU DEBUT DU PRECHAUFFAGE, ET ALIMENTE SOUVENT CERTAINS EQUIPEMENTS EXTERNES QUI PEUVENT GENERER DU BRUIT.</p>

4.4.4.1 Front Panel Speed Control

The operator is able to adjust the speed of the engine by using the controller's front panel. This section describes the two methods available for implementing speed control, the settings and the parameters to be used, and the necessary instructions allowing the operator to control the speed.



Speed Control Methods

Setting	Description
Front Panel Speed Control using J1939 TSC1	The controller can instruct the ECM of an electronic engine to adjust its speed by broadcasting the TSC1 command. Refer to the J1939 Reference Manual for more information.
Front Panel Speed Control using Switched Outputs	The controller can instruct the ECM of an electronic engine to adjust its speed by using switched outputs on the controller set to RPM Increment and RPM Decrement to interface with digital inputs on the ECM. When the speed is changed, the corresponding switched output will be on for 1 second each time increment or decrement is pressed. See the rest of this section for more information.
Aux 4 Speed Control	The Auxiliary Sensor 4 is used to determine the setpoint speed. The speed is adjusted with the TSC1 J1939 command. Refer to the J1939 Reference Manual for more information.

	WARNING
	SWITCHED OUTPUTS HAVE A FLOATING VOLTAGE OF APPROXIMATELY 8 V WHEN OFF. IF USING THE OUTPUTS FOR DIGITAL LOGIC, IT WILL BE NECESSARY TO PUT A PULL-DOWN RESISTOR (2.2 KΩ, 1 WATT) FROM THE OUTPUT TO GROUND TO ENSURE A LOW LOGIC LEVEL WHEN OUTPUT IS OFF.

	AVERTISSEMENT
	LES SORTIES COMMUTEES PRESENTENT UNE TENSION FLOTTANTE D'ENVIRON 8 V LORSQU'ELLES SONT OFF (INACTIVES). SI VOUS SOUHAITEZ UTILISER LES SORTIES COMME SIGNAUX LOGIQUES NUMERIQUES, IL FAUT INSTALLER UNE RESISTANCE PULL-DOWN (2,2 KΩ, 1 W) ENTRE LA SORTIE CONCERNEE ET LA MASSE, POUR ASSURER UN NIVEAU LOGIQUE BAS QUAND LA SORTIE EST OFF.

Front Panel Speed Control Using the Switched Outputs

Settings

Name	Parent Menu	Range	Default	Description
Speed Control Enable	RapidCore only. Engine Speed menu.	Enable Disable	Disable	(Programmable from RapidCore Configurator Software only) Enables or disables front panel speed control.
RPM Display	Sensors > Engine Speed	Blank AC Hertz Aux Sensor 1 Aux Sensor 2	AC Hertz	Parameter to display when adjusting speed from front panel. This is used to provide operator feedback in the case that the engine RPM affects another parameter such as AC Frequency or an Auxiliary Sensor (example: flow rate of pump).



Name	Parent Menu	Range	Default	Description
Limit Method	RapidCore only. Engine Speed menu.	Speed Bias Min RPM / Max RPM	Speed Bias	(Programmable from RapidCore Configurator Software only) The method in which the minimum and maximum speeds the operator is allowed to adjust is determined.
Speed Bias	Sensors > Engine Speed > RPM Control	0 ~ 600 RPM in 1 RPM increments	30 RPM	The minimum or maximum RPM that the engine speed can be adjusted around the Rated RPM. Example: Rated RPM is 1800 and Speed Bias is 150. The minimum RPM will be 1650 and maximum RPM will be 1950. Only valid when the correct Limit Method is chosen.
Min Speed		500 ~ 4000 RPM in 1 RPM increments	600 RPM	The minimum RPM that can be set using speed control. Only valid when the correct Limit Method is chosen.
Max Speed		500 ~ 4000 RPM in 1 RPM increments	2000 RPM	The maximum RPM that can be set using speed control. Only valid when the correct Limit Method is chosen.
TSC1 RPM/s	Sensors > Engine Speed > RPM Control	Disable 10 ~ 300 RPM/s in 10 RPM/s increments	200 RPM/s	Ignore this setting. Refer to the J1939 Reference Manual for information on this setting.

Speed Control Instructions

When the controller is running and there are other functions occurring, the controller will scroll through its display parameters as usual. When the speed control page is displayed, it will show the Engine Speed as well as the following instructions: Hold AUTO + Up/Down to Adjust RPM.

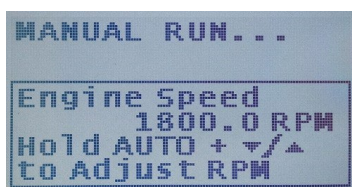

Speed Control Parameter Page

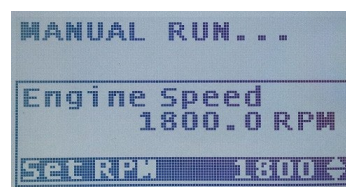

Speed Control Adjust Page

Pressing and holding the AUTO button will display the screen to the right. If a 'Display Adjust Parameter' is set, it will also be displayed underneath the Engine Speed. While still holding the AUTO key, press the up or down arrows to adjust the RPM. The Engine Speed display should update as the engine physically changes its speed to accommodate the speed request.



	CAUTION
	WHEN USING SWITCHED OUTPUTS FOR SPEED CONTROL, THE SET RPM WILL DISPLAY '---' INSTEAD OF THE SET SPEED.

	ATTENTION
	SI VOUS UTILISEZ DES SORTIES COMMUTEES POUR LA COMMANDE DE VITESSE, SET RPM (REGIME MOTEUR DE CONSIGNE EN TOURS/MINUTE) AFFICHERA « --- » AU LIEU DU REGIME DE CONSIGNE.

4.4.4.2 RPM Output

This feature can be used to turn an output on and off when the speed of the engine/generator rises or falls below a given speed.

To use this feature, a [Switched Output](#) has to be set to “RPM Output”.

(Sensors > Engine Speed)

Name	Range	Default	Description
RPM Output	Sub menu	----	----
RPM Output > Debounce	0.2 ~ 10 s in 0.2 s increments	2 s	Sets the time to wait before turning on or off the switched output.
RPM Output > Trigger	Disable Under Over	Disable	Sets when to turn on the switched output relative to the Switched RPM setting.
RPM Output > Switch RPM	500 to 3000 RPM in 1 RPM increments	1800 RPM	Sets the RPM to trigger on. Trigger is based on this setting.

4.4.5 Battery

Use the following settings' configurations to allow the controller to read and interpret the battery voltage level.

Name	Range	Default	Description
Battery Recharge	Enable Disable	Disable	Enables or disables the ability to have the engine start on low battery voltage in order to charge it.
Recharge Setup > Level	6.0 - 30.0 V	10.4 V	Voltage level at which the controller starts the engine to recharge the battery.
Recharge Setup > Pre-Alarm	1 ~ 30 min	5 min	Amount of time to display a warning before starting the engine.
Recharge Setup > Duration	10 ~ 900 min	90 min	Amount of time to run the engine.



Name	Range	Default	Description
Setpoints > Low Warning	Disabled 6.0 ~ 24.0 V	11.3 V	Reading at which a warning occurs.
Setpoints > Low Failure	Disabled 6.0 ~ 24.0 V	Disabled	Reading at which a failure occurs.
Setpoints > High Warning	Disabled 12.0 ~ 32.0 V	Disabled	Reading at which a warning occurs.
Setpoints > High Failure	Disabled 12.0 ~ 32.0 V	Disabled	Reading at which a failure occurs.
LowBat InCrank	6.0 ~ 24.0 V	8.0 V	Screen displays a 'Low Voltage During Cranking' warning if voltage dips below this level during cranking.

	CAUTION
	WHEN THE ENGINE IS RUNNING, THE BATTERY VOLTAGE WILL EQUAL THE ALTERNATOR CHARGING VOLTAGE. THE ACTUAL OPEN-CIRCUIT BATTERY VOLTAGE MAY BE LOWER THAN DISPLAYED.

	ATTENTION
	QUAND LE MOTEUR TOURNE, LA TENSION DE BATTERIE EST EGALE A LA TENSION DE CHARGE DE L'ALTERNATEUR. LA TENSION REELLE DE LA BATTERIE EN CIRCUIT OUVERT PEUT ETRE INFERIEURE A CELLE AFFICHEE.



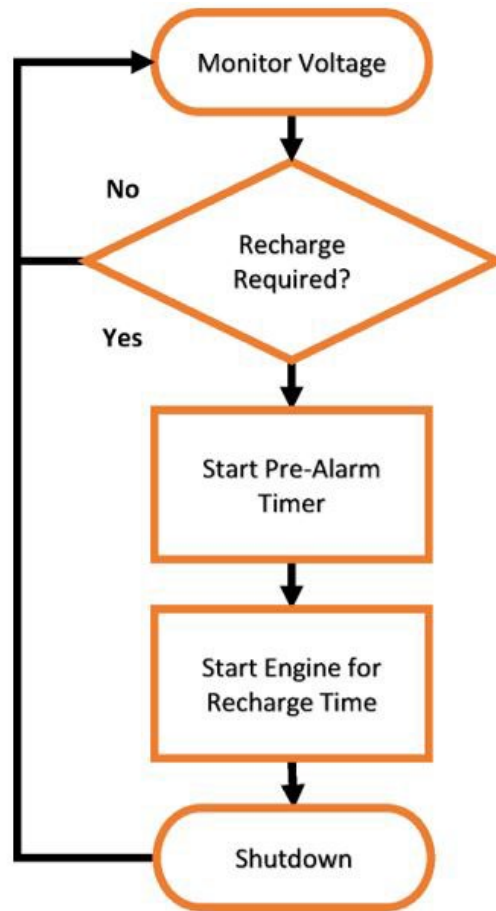

Battery Recharge Sequence

4.4.6 Auxiliary Sensors

The Auxiliary sensors are used for supporting custom sensors and triggering actions based on the sensor values. There are four auxiliary sensors.

Note: There is a fifth sensor – the Transducer Sensor (Auxiliary Sensor 5 in RapidCore) – that is similar to the Auxiliary Sensors. It is set in the Application Menu > (or Sensors > Auxiliary Sensor 5 in RapidCore). The following menus are for the Auxiliary Sensors.

	<p>CAUTION</p> <p>YOU MUST USE THE RAPIDCORE CONFIGURATOR SOFTWARE TO PROGRAM A CUSTOM SENDER TABLE TO THE CONTROLLER FOR THE AUXILIARY SENSOR(S) THAT WILL BE USED. OTHERWISE "UNDEFINED SENSOR" WILL APPEAR MENU IN THE FRONT PANEL MENU SYSTEM. ONCE A SENDER TABLE IS PROGRAMMED TO THE CONTROLLER ALL THE OTHER SETTINGS CAN BE ADJUSTED FROM THE FRONT PANEL OF THE CONTROLLER.</p>
---	--



	ATTENTION
	<p>VOUS DEVEZ UTILISER LE LOGICIEL RAPIDCORE CONFIGURATOR POUR PROGRAMMER UN TABLEAU D'EMISSION PERSONNALISE SUR LE CONTROLEUR, POUR LE OU LES CAPTEURS AUXILIAIRES QUI SERONT UTILISES. SINON, LE MESSAGE « UNDEFINED SENSOR » (CAPTEUR NON-DEFINI) S'AFFICHERA DANS LE MENU DU PANNEAU DE COMMANDE. UNE FOIS QU'UN TABLEAU D'EMISSION EST PROGRAMME DANS LE CONTROLEUR, TOUS LES AUTRES PARAMETRES PEUVENT ETRE REGLES A PARTIR DU PANNEAU DE COMMANDE DU CONTROLEUR.</p>

(Sensors > Aux Sensor 1/2/3/4 menus)

Name	Range	Default	Description
Signal Source	Disable Port A Port B Port C Port D	Disable	The source from which to get the signal for the Aux Sensor. Any port can be used, even if it is used by another sensor or Aux Sensor. If the port is in use by other sensor, this is known as <i>overloading</i> the port.
Custom Sender (Configurator Software only)	-----	Undefined	The sender resistance / value curve must be programmed from the RapidCore Configurator Software even if the port is being overloaded. This tells the controller how to interpret the signal from the port. No front panel configuration is allowed until the sender curve is programmed to the controller.
Display	Enable Disable	-----	Determines if the sensor's value is displayed on the screen when the engine is running.



Name	Range	Default	Description
Active Mode	Disable Global Off Mode (Not in Auto) Auto Mode Running Cranking After Cranking Cooldown	----	<p>Determines under which operating conditions the Auxiliary Sensor is monitored. Multiple selections are allowed. Does not apply to “Start on Low” or “Start on High”; for those selections, the active mode is always Auto.</p> <p>Refer to the examples in the following pages for information on specific mode functions.</p> <ul style="list-style-type: none"> - Disable - Input cannot be triggered - Global - Input can be triggered at any time - Off Mode - Input can be triggered while in the Off Mode - Auto Mode - Input can be triggered while in the Auto Mode - Running - Input can be triggered after a start command is received until shutdown (cooldown not included) - Cranking - Input can be triggered during cranking - After Cranking - Input can be triggered after engine has started until shutdown - Cooldown - Input can be triggered while cooldown timer is active
Func. Select	Fault Monitor Output on Low Output on High Start on Low Start on High	----	<p>Determines how the controller responds to the readings of the Auxiliary Sensor.</p> <p>“x on Low” will turn on the output or start the controller if the sensor input falls below the Start Level.</p> <p>“x on High” will turn on the output or start the controller if the sensor input rises above the Start Level.</p>
Trim Offset	-50.0 ~ 50.0 units The units depend on the unit type of the programmed sender table -- °F, PSI, %, V, A	----	Calibrate a sensor by using the offset to correct errors.
Mode Settings > Bypass Time	0 ~ 90 s in 1 s increments	----	The amount of time to ignore the sensor input after the desired active mode is first entered. Once triggered, the bypass time does not apply again until the device resets (for example, transitioning from Run to the Off or Auto state) or on power-up.



Name	Range	Default	Description
Mode Settings > Run Time	Disable 1 ~ 6000 min* in 1 min increments	----	<p>(Only applies if Func. Select is not set to Fault Monitor) The amount of time to turn on the auxiliary switched output or run the controller before turning off the output or shutting down the controller.</p> <p>If the Run Time is disabled, then the start/output is held until the Stop Level is reached (if enabled) or until the controller is reset or powered down or, in the case of Start on Low / Start on High, until the user presses the OFF button.</p> <p>Note that the run time is not exact. Up to 10 seconds may be added to the beginning of the run time counter and up to 4 seconds to the end. The run time begins when a start request is received so crank time, preheat time, etc., are included in the Run Time.</p>
Mode Settings > Start Level	Disable Temperature: 32 ~ 999 °F in 1 °F increments Pressure: 1 ~ 6000 PSI in 1 PSI increments Level:	----	<p>(Only applies if Func. Select is not set to Fault Monitor) The level at which the auxiliary switched output turns on or the engine starts.</p> <p>If this is set to Disable, the Auxiliary Sensor action defined in Func. Select is disabled. The Auxiliary Sensor becomes display only (unless Func. Select is set to Fault Monitor).</p>
Mode Settings > Stop Level	1 ~ 99% in 1% increments Voltage: 0.1 ~ 99.9 V in 0.1 V increments Current: 1 ~ 999 A in 1 A increments		<p>(Only applies if Func. Select is not set to Fault Monitor) The level at which the auxiliary switched input turns off or the engine is stopped.</p> <p>If Stop Level is disabled, the start/output condition is maintained until the Run Time expires (if enabled) or until the controller is reset or powered down or, in the case of a start, until the user presses the OFF button.</p>
Setpoints > Low Warning			(Only applies if Func. Select is set to Fault Monitor) Reading at which a warning occurs.
Setpoints > Low Failure			(Only applies if Func. Select is set to Fault Monitor) Reading at which a failure occurs.
Setpoints > High Warning			(Only applies if Func. Select is set to Fault Monitor.) Reading at which a warning occurs.
Setpoints > High Failure			(Only applies if Func. Select is set to Fault Monitor.) Reading at which a failure occurs.
Timers > Trigger Delays Aux Sensors menu:			
Aux 1	1 to 3600 s in 1 s increments	5 s	<u>Func. Select is set to fault monitor:</u> Sets the amount of time to ignore the input for warning and
Aux 2			



Name	Range	Default	Description
Aux 3			failure detection purposes. No warnings or failures will be generated during this time.
Aux 4			"Func. Select" set to other than fault monitor: Sets the amount of time to delay a start or stop event. If set to larger than 4 s the stop delay portion is limited to 4 s. If the trigger for the start or stop event becomes unavailable during this time the time will be reset and the controller will wait for the next start/stop trigger. <u>Limitations:</u> For TG350/TG410 firmware versions below 1.88.01, the maximum range is 45 s.

* 1 ~ 600 min for firmware versions below 1.78.

If using *Output on Low* or *Output on High*, one of the switched outputs events must be set to one of the following, corresponding to the Auxiliary Sensor being configured per the following table.

(Switched I/O > Switched Out A/B/C/D/E/F > Events menus)

Name	Description
Aux Sensor 1	Used by the Auxiliary Sensor 1 <i>Output on Low</i> or <i>Output on High</i> feature.
Aux Sensor 2	Used by the Auxiliary Sensor 2 <i>Output on Low</i> or <i>Output on High</i> feature.
Aux Sensor 3	Used by the Auxiliary Sensor 3 <i>Output on Low</i> or <i>Output on High</i> feature.
Aux Sensor 4	Used by the Auxiliary Sensor 4 <i>Output on Low</i> or <i>Output on High</i> feature.

The display resolution of the auxiliary sensors that are displayed on the screen are different than the resolution used for the purpose of the comparisons that determine if the start level, stop level, low warning, etc., are in effect. The resolutions are given in the following table.

Sensor Unit Type	Comparison Resolution
Temperature	1 °F
Pressure	1 PSI
Level	1%
Voltage	0.1 V
Current	1 A

Example: If the Auxiliary Sensor 1 (Aux 1) is using a temperature sender curve, set to *Output on Low*, and the Start Level is set to 130 °F, then the Output will not turn on until the temperature drops to 129 °F since the resolution for comparisons is 1 °F.

The following tables gives all the possible actions that the auxiliary sensors can perform.



	Behavior	Func. Select	Start Level	Run Time	Stop Level
A - Indefinitely	Start controller when the sensor drops below a certain value. Run indefinitely. ¹	Start on Low	Set to value that the sensor needs to drop below to start.	Disable	Disable
	Turn on an output when the sensor drops below a certain value. Keep the output on indefinitely. ²	Output on Low	Set to value that the sensor needs to drop below to turn on the output.	Disable	Disable
	Start controller when the sensor rises above a certain value. Run indefinitely. ¹	Start on High	Set to value that the sensor needs to rise above to start.	Disable	Disable
	Turn on an output when the sensor rises above a certain value. Keep the output on indefinitely. ²	Output on High	Set to value that the sensor needs to rise above to turn on the output.	Disable	Disable
B - Fixed Duration	Start controller when the sensor drops below a certain value. Run for a fixed period of time and then stop controller.	Start on Low	Set to value that the sensor needs to drop below to start.	Set to the desired run duration.	Disable
	Turn on an output when the sensor drops below a certain value. Run for a fixed period of time and then turn off the output.	Output on Low	Set to value that the sensor needs to drop below to turn on the output.	Set to the desired duration to keep the output on.	Disable
	Start controller when the sensor rises above a certain value. Run for a fixed period of time and then stop controller.	Start on High	Set to value that the sensor needs to rise above to start.	Set to the desired run duration.	Disable
	Turn on an output when the sensor rises above a certain value. Run for a fixed period of time and then turn off the output.	Output on High	Set to value that the sensor needs to rise above to turn on the output.	Set to the desired duration to keep the output on.	Disable
C - Start Level / Stop Level	Start controller when the sensor drops below a certain value. Stop controller when the sensor rises above a certain value.	Start on Low	Set to value that the sensor needs to drop below to start.	Disable	Set to the value the sensor needs to rise above to stop the controller.



	Behavior	Func. Select	Start Level	Run Time	Stop Level
	Turn on an output when the sensor drops below a certain value. Turn off output when the sensor rises above a certain value.	Output on Low	Set to value that the sensor needs to drop below to turn on the output.	Disable	Set to the value the sensor needs to rise above to turn off the output.
	Start controller when the sensor rises above a certain value. Stop controller when the sensor drops below a certain value.	Start on High	Set to value that the sensor needs to rise above to start.	Disable	Set to the value the sensor needs to drop below to stop the controller.
	Turn on an output when the sensor rises above a certain value. Turn off output when the sensor drops below a certain value.	Output on High	Set to value that the sensor needs to rise above to turn on the output.	Disable	Set to the value the sensor needs to drop below to turn off the output.
D - Start Level / Stop Level with Timeout	Start controller when the sensor drops below a certain value. Stop controller when the sensor rises above a certain value. Stop the controller after a fixed time if the stop level is not reached.	Start on Low	Set to value that the sensor needs to drop below to start.	Set to the desired maximum run duration (i.e., this is the timeout).	Set to the value the sensor needs to rise above to stop the controller.
	Turn on an output when the sensor drops below a certain value. Turn off output when the sensor rises above a certain value. Turn off the output after a fixed time if the stop level is not reached.	Output on Low	Set to value that the sensor needs to drop below to turn on the output.	Set to the desired maximum duration to keep the output on (i.e., this is the timeout).	Set to the value the sensor needs to rise above to turn off the output.
	Start controller when the sensor rises above a certain value. Stop controller when the sensor drops below a certain value. Stop the controller after a fixed time if the stop level is not reached.	Start on High	Set to value that the sensor needs to rise above to start.	Set to the desired maximum run duration (i.e., this is the timeout).	Set to the value the sensor needs to drop below to stop the controller.



	Behavior	Func. Select	Start Level	Run Time	Stop Level
	Turn on an output when the sensor rises above a certain value. Turn off output when the sensor drops below a certain value. Turn off the output after a fixed time if the stop level is not reached.	Output on High	Set to value that the sensor needs to rise above to turn on the output.	Set to the desired maximum duration to keep the output on (i.e., this is the timeout).	Set to the value the sensor needs to drop below to turn off the output.
E - Warnings / Failures	Trigger warnings and/or failures on the sensor.	Fault Monitor	N/A	N/A	N/A
F - Display only	Do not perform any actions based on the sensor value. Just display the value to the user.	Fault Monitor (Disable all warnings and failures)	N/A	N/A	N/A

¹ The user must manually stop the controller by pressing the OFF button.

² The controller must be either

- Powered down, or
- A reset initiated by
 - Going from the Run Mode to the Auto or Off Mode, or
 - Changing a setting in the menu and exiting the menu system

4.4.6.1 *Fault Monitor Example*

In this example, a sensor is monitoring the temperature of an engine block. If the temperature rises above 275 °F, a warning message is displayed. If the temperature rises above 350 °F, the engine shuts down and a failure message is displayed.

Relevant Settings

Setting	Value
Signal Source	Same as Engine Temperature
Display	Disable (if enabled, controller will display Engine Temperature twice)
Sensor Type	Same as Engine Temperature
Sensor Table Name	Engine Temp.
Active Range	Running
Mode Select	Fault Monitor
Setpoints > Low Warning	Disabled



Setting	Value
Setpoints > Low Failure	Disabled
Setpoints > High Warning	275 °F
Setpoints > High Failure	350 °F

The following chart shows the connection between engine temperature and time. At approximately 13 minutes run time, the temperature rises above the 275 °F warning threshold, activating the warning display. The engine will continue to run because it has not reached the 350 °F failure threshold. At 20 minutes run time, the temperature falls below the warning threshold, and the warning disappears.

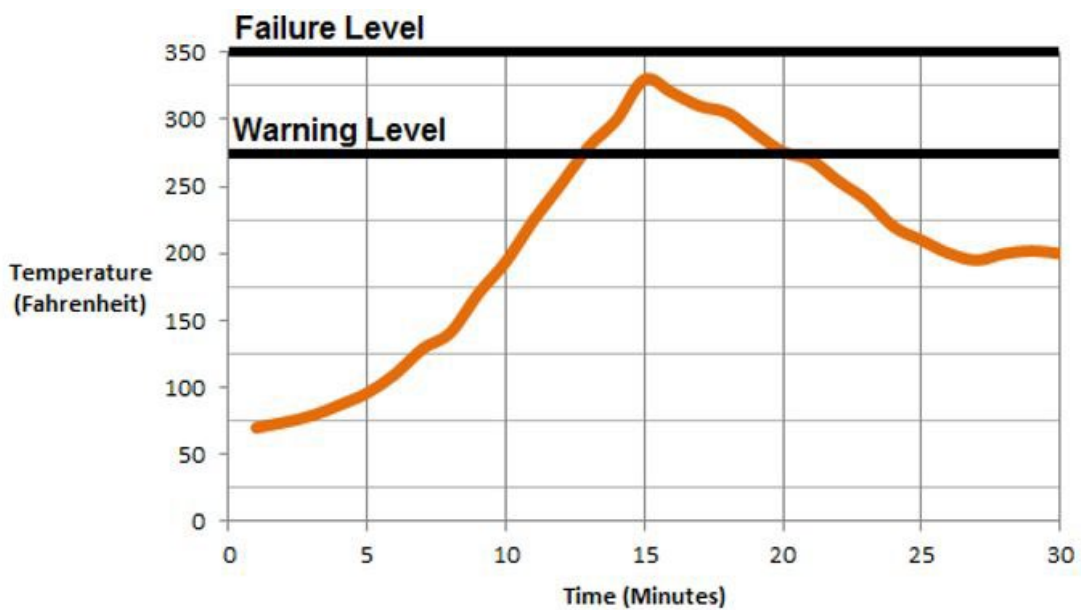

4.4.6.2 Start on Low Example

In this example, a sensor is monitoring the voltage of an external battery bank. If the voltage falls below 10.5 V, the engine will start and run for 40 minutes to charge the battery.

Relevant Settings

Setting	Value
Signal Source	Sensor Port X
Display	Enable
Sensor Type	Custom
Sensor Table Name	Battery Bank
Active Range	N/A (these ranges are fixed for Start on Low / High)



Setting	Value
Mode Select	Start on Low
Mode Settings > Active Time	40 min
Mode Settings > Start Level	10.5 V
Mode Settings > Stop Level ¹	Disabled

¹Stop Level needs to be disabled when the engine is running because the battery voltage will equal the alternator charging voltage. Having this disabled will force the engine to run for the entire duration of the active time.

The following chart shows the connection between a battery bank and time. At approximately 80 minutes time, the voltage falls below the 10.5 V start threshold, causing the engine to start. The engine runs for the 40 minutes of active time, regardless of the voltage reading, and then shuts down.

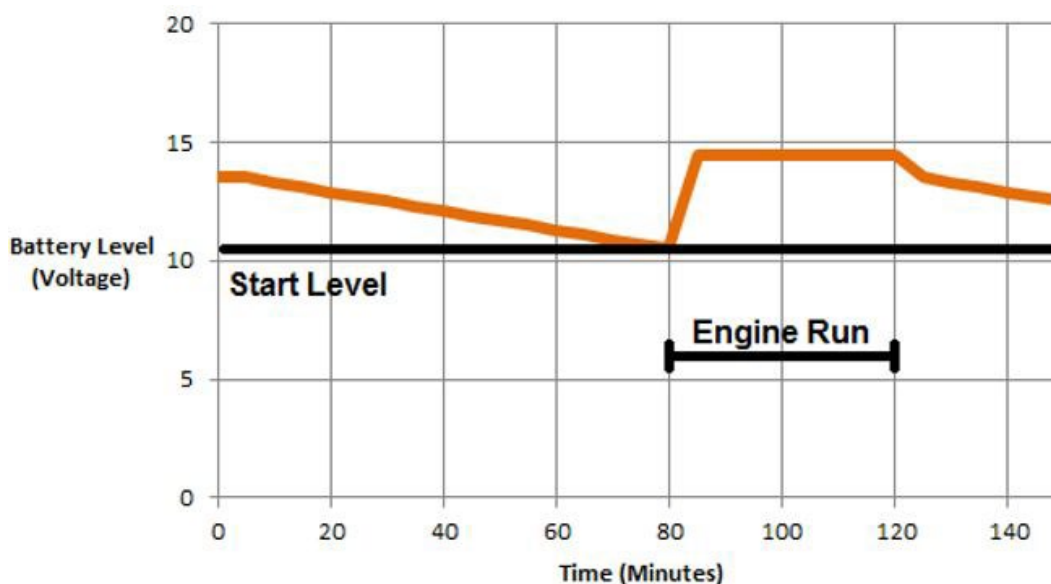

4.4.6.3 Output on High Example

In this example, a sensor is monitoring the temperature of an engine. If the temperature rises above 325 °F, a fan will turn on to cool the engine. Once the temperature drops to below 200 °F, the fan will turn off.

Relevant Settings (Auxiliary Sensor)

Setting	Value
Signal Source	Same as Engine Temperature
Display	Disable (if enabled, controller will display Engine Temperature twice)
Sensor Type	Same as Engine Temperature
Sender Table Name	Engine Temp.



Setting	Value
Active Range	Global
Mode Select	Output on High
Mode Settings > Active Time ¹	Disabled
Mode Settings > Start Level	325 °F
Mode Settings > Stop Level	200 °F

¹Active time is disabled because the fan needs to stay on indefinitely or until 200 °F is reached.

Relevant Settings (Switched Outputs)

Setting	Value
Switched Output X	Auxiliary Sensor X (choose based on which Auxiliary Sensor is being used)

The following chart shows the connection between engine temperature and time. At approximately 10 minutes run time, the temperature rises above the 325 °F start threshold and the fan turns on. The fan continues to run as the temperature declines. When the temperature falls below the 200 °F stop threshold, the fan turns off.

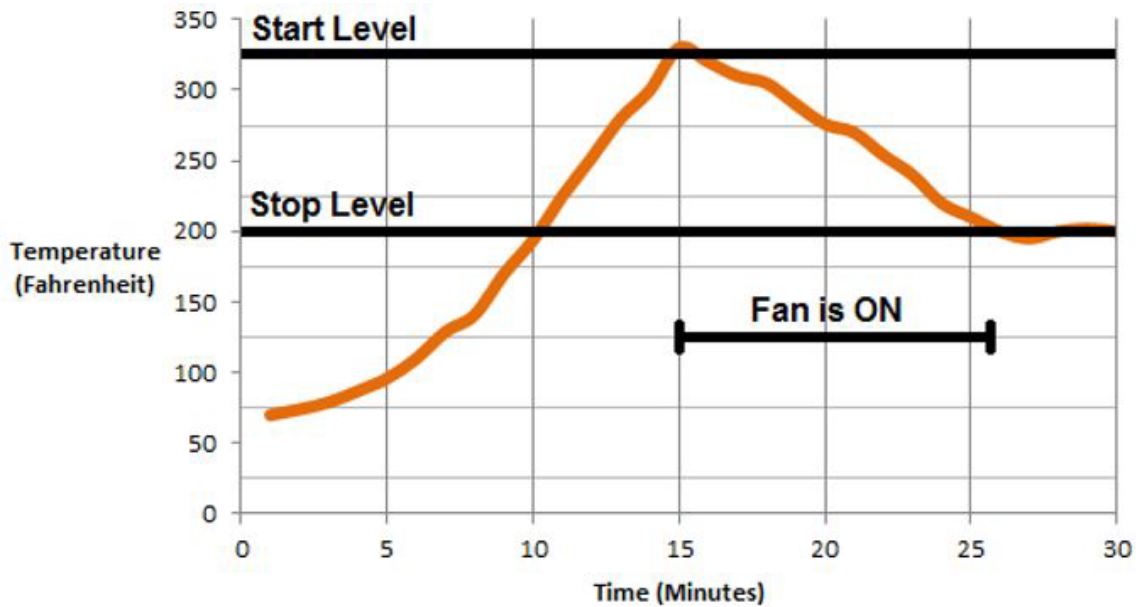

4.4.7 Custom Sender Tables

Custom Sender Tables are created using the RapidCore Configurator Software when using a sensor that is not supported by Cattron. The Configurator Software has the ability to create these custom tables, allowing the controller to properly read the sensor data.



	CAUTION
	CUSTOM SENDER TABLES CAN ONLY BE CREATED WHEN USING THE CONFIGURATOR SOFTWARE.

	ATTENTION
	LES TABLEAUX D'EMISSION PERSONNALISES NE PEUVENT ETRE CREES QU'AVEC LE LOGICIEL CONFIGURATOR.

Parameter	Description
Name	The label that will be displayed in the controller (Engine Temp, Oil Pressure, etc.).
Input Type	Choose resistance, voltage or current based on the sensor type. Use the Terminal Descriptions section to determine if your sensor is compatible with a sensor port.
Unit Type	Choose temperature, pressure, voltage, current or percentage based on the sensor. This defines what unit of measurement will be displayed on the front panel (°F, PSI, V, A, %).

The following example outlines the steps for creating a custom sender table:

1. Navigate to the sensor input that will be using your custom sender table.
2. Select a Name, Input Type and Unit Type for the controller (definitions in the table above).
3. Click the check box next to 'Build Table' (Step 1 in the following image).
4. From the 'Sender' drop-down menu, select 'Custom' (Step 2 in the following image).
5. Click the 'Edit' button next to the drop-down menu (Step 3 in the following image).
6. Enter the sensor values. Once entered, click Apply, then OK.



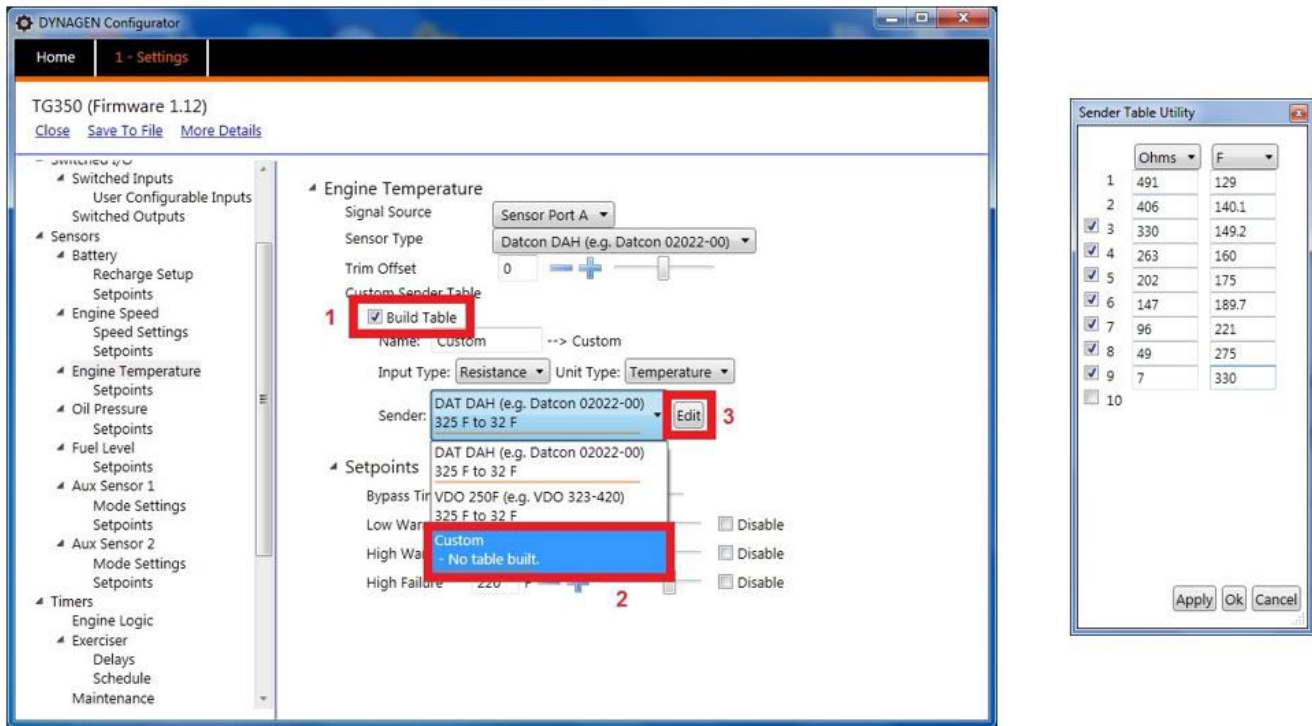

4.5 Timers

The controller has an internal clock which is used not only to keep time, but also to ensure that programmed events happen at the correct times. The following sections are used to configure settings associated with timing functions.

	CAUTION
	THE CONTROLLER HAS AN ON-BOARD BACKUP BATTERY TO KEEP TIME EVEN WHEN THE MAIN POWER IS NOT SUPPLIED TO THE UNIT. THIS BATTERY HAS AN UNPOWERED (NO MAIN POWER) LIFETIME OF APPROXIMATELY FIVE YEARS.

	ATTENTION
	LE CONTROLEUR DISPOSE D'UNE BATTERIE DE SECOURS INTEGREE, QUI PERMET DE CONSERVER L'HEURE MEME QUAND L'UNITE N'EST PAS CONNEXE A L'ALIMENTATION PRINCIPALE. CETTE BATTERIE A UNE DUREE DE VIE D'ENVIRON CINQ ANS SANS ALIMENTATION (EN L'ABSNECE D'ALIMENTATION PRINCIPALE).

4.5.1 Engine Logic

The following settings determine how the controller starts and stops the engine. It gives the user the functionality to add delays and timers to the sequences. Most of the settings have a switched output associated with them that must be set in the settings for [Switched Outputs](#).



	CAUTION
	SETTING A TIMER'S VALUE TO 0 SECONDS WILL DISABLE THE TIMER. FOR EXAMPLE, IF DELAY TO START IS SET TO 0 S, THE CONTROLLER WILL NOT PERFORM A DELAY TO START WHEN STARTING THE ENGINE.

	ATTENTION
	REGLER LA MINUTERIE SUR 0 SECONDE A POUR EFFET DE LA DESACTIVER. PAR EXEMPLE, SI DELAY TO START (RETARD AU DEMARRAGE) EST REGLE SUR 0 S, LE CONTROLEUR N'APPLIQUERA PAS DE RETARD AU DEMARRAGE LORS DU DEMARRAGE DU MOTEUR.

Timers > Engine Logic:

Name	Range	Default	Description
Delay to Start	0 ~ 90 s	0 s	Amount of time to delay the starting of the engine after receiving a command to start.
DTS Manual Run (Delay to Start on Manual Run)	Disable Delay or Enable Delay	Enable Delay	Determines if the Delay to Start timer is used when the front panel RUN button is used to start the engine.
Preheat Mode	Preheat Timer Switched Input J1939	Preheat Timer	Determines the method used to control enabling the Glowplug output. See the Preheat Mode section for more information.
Preheat Time	0 ~ 1200 s 0 ~ 90 s in firmware versions below 1.33	0 s	Amount of time the <u>Glowplug output</u> is active before cranking the engine. Used on diesel engines to warm the engine before cranking.
Crank Time	3 ~ 30 s	10 s	Amount of time the <u>Crank output</u> is active before going to crank rest. This timer immediately expires upon successful cranking.
Midheat Time	0 ~ 90 s	0 s	Keeps <u>Glowplug output</u> turned on while cranking but not during crank rest. Output will turn off upon crank failure, crank success or midheat time expiration.
Crank Rest Time	1 ~ 90 s	15 s	Amount of time to delay between each attempt to start the engine.
Crank Attempts	1 ~ 20	3	Number of attempts to start the engine before going to an overcrank failure.
Fuel In Rest (Fuel Crank Rest)	Fuel ON or Fuel OFF	Fuel ON	Determines if the fuel output stays on during the crank rest time.



Name	Range	Default	Description
RPM Disconnect	100 ~ 2000 RPM	650 RPM	Speed at which controller determines the engine has started successfully and turns off the <u>Crank output</u> .
Postheat Time	0 ~ 90 s	0 s	Amount of time the <u>Glowplug output</u> remains on after crank success and the engine is running.
False Restart (Restart on False Start)	Enable false start (engine stall) detection. Refer to the False Restart section.		
False Check (False Restart Detect Time)			
Engine Stall	Enable Disable	Disable	If enabled, after the false restart delay and if the engine speed goes below the crank disconnect setting, (1) disables oil pressure shutdown, and (2), after two seconds the controller will shut down on an "engine stall" failure. This prevents an erroneous low oil pressure, under speed, or under frequency failure. Available in firmware version 1.87 and above.
Warmup Time	0 ~ 600 s in 5 s increments	0 s	After successful cranking, engine delays this amount of time before turning on the <u>Warmup output</u> . This allows the engine to warm up before applying any load to it. The output will turn off when the controller enters the Cooldown Delay.
OFF Button Function	Cooldown Shutdown Force Cooldown	Shutdown	The function the OFF button on the front panel performs while engine is running. See the OFF Button Function section for more information.
Cooldown Time	0 ~ 6000 s in 5 s increments	0 s	Amount of time to cool down the engine after a stop command has been received. During this time the <u>Warmup output</u> turns off and the <u>Cooldown output</u> turns on. If another start command is received during cool down, the controller will return to Running Mode.



Name	Range	Default	Description
ETS On Duration (Energize to Stop)	0 ~ 30 s	0 s	Amount of time the <u>Energize to Stop (ETS) output</u> is on after the engine has shut down. Time must be greater than 0 s for the Energize to Stop function to work. As of TG350/TG410 version 1.88, the OFF button is disabled during ETS to prevent possible issues with the engine failing to shut down. If controller still detects speed (RPM) above 600 RPM in the last two seconds, it goes to a ' Failed to Stop ' failure.
Warm-up Idle	Idle options. See the Idle section for more information.		
Idle Settings			
Cooldown Idle			
Auto Idle Link			

4.5.1.1 Preheat Mode

The controller has the ability to control the length of the preheat time through three different methods. The following table describes each method.

Preheat Mode Settings (under Timers > Engine Logic menu)

Mode	Description
Preheat Timer	This mode uses the Preheat Time setting in the Engine Logic menu.
Switched Input	This mode uses a switched input set to 'ECM Preheat' to determine when to exit preheat. The preheat time (in Engine Logic) must be set to a minimum of 5 seconds for this input to work. If the switched input is or becomes active when the preheat timer is counting down, the controller displays 'ECM Preheating' on the screen after the preheat counter has finished its countdown. Cranking begins when the 'ECM Preheat' switched input is no longer active.
J1939	This mode uses commands sent from the ECM over J1939 to decide when to exit preheat.



CAUTION

DURING PREHEAT, THE GLOWPLUG SWITCHED OUTPUT IS ON (IT NEEDS TO BE SET TO A SWITCHED OUTPUT – SEE [SWITCHED OUTPUTS](#)).



	ATTENTION
	PENDANT LE PRECHAUFFAGE, LA SORTIE COMMUTEE GLOWPLUG (VOYANT DE PRECHAUFFAGE) EST ACTIVEE (ELLE DOIT ETRE PARAMETREE EN SORTIE COMMUTEE - VOIR SWITCHED OUTPUTS (SORTIES COMMUTEES)).

4.5.1.2 False Restart

The false restart feature is used to monitor and recover from unsuccessful crank attempts where the speed did go above the crank disconnect and the controller is in the Run Mode. For example, the engine might have stalled shortly after cranking.

False Restart Settings (under Timers > Engine Logic)

Name	Range	Default	Description
False Restart (Restart on False Start)	Enable Disable	Disable	Determines if the controller will monitor for false starts and attempt a restart. Controller will only attempt restarting the engine as many times as determined by Crank Attempts.
False Check (False Restart Detect Time)	5 ~ 30 s in 1 s intervals	8 s	Amount of time after successful cranking to monitor for a false restart. A false restart is defined as the speed dropping below 250 RPM for 2 seconds. If this time expires and the engines stalls out, the controller will not attempt a restart. This time starts from crank success.

Tip: It takes up to 2 seconds for the false restart to be triggered. In addition, it takes time for the engine speed to drop below 250 RPM. These should be measured and added to the desired False Check setting.

For example, when the speed is disconnected, it takes approximately 2.5 s for the speed sensing to record 0 RPM when the speed sensing is set to a magnetic input at a speed of 3200 Hz/1800 RPM. This totals 4.5 s when you include the 2 s for the false restart delay. So, if the desired monitoring period is 10 s, the False Check setting should be set to 15 s.



4.5.1.3 OFF Button Function

The OFF button on the front panel of the controller can be configured to function in three different ways while the engine is running. The following table describes each of these functions.

Function	Description
Cooldown	This function causes the controller to go into cooldown. Pressing the OFF button again will cause the engine to shut down.
Shutdown	This function bypasses cooldown and causes the engine to shut down.
Force Cooldown	This function causes the controller to activate the cooldown process. Pressing the OFF button will have no effect as the controller is forcing the engine to perform a full cool down.

	WARNING
	IF THE CONTROLLER RECEIVES A COMMAND TO START FROM THE REMOTE START OR FRONT PANEL RUN BUTTON WHILE IN COOLDOWN, IT WILL LEAVE THE COOLDOWN MODE AND GO BACK TO RUNNING MODE.

	AVERTISSEMENT
	SI LE CONTROLEUR REÇOIT UNE COMMANDE DE DEMARRAGE A PARTIR DE LA COMMANDE DE DEMARRAGE A DISTANCE, OU DU BOUTON RUN (MARCHE) DU PANNEAU DE COMMANDE ALORS QU'IL EST EN MODE COOLDOWN (REFROIDISSEMENT), IL QUITTERA LE MODE COOLDOWN (REFROIDISSEMENT) ET REVIENDRA AU MODE RUNNING (MARCHE).

4.5.1.4 Idle

The controller ignores under speed, voltage and frequency warnings and failures when active. If using J1939, the controller will broadcast TSC1 as the Idle Speed parameter found in the [Engine Speed](#) section.

This section explains the general Idle functionality. There are three ways to use Idle, as follows:

- [Warmup Idle](#) – Automatically enter the Idle Mode during warmup for a period of time before going to rated speed; see [Warmup Idle](#)
- [Cooldown Idle](#) – Idle automatically during cool down; see below
- [Idle Switched Input](#) – Idle whenever this switched input is active; see the Idle Mode function under [Switched Inputs](#)

Name	Parent Menu	Range	Default	Description
Warmup Idle	Timers > Engine Logic	Disable Warm-up Timer Oil Temp. Engine Temp.	Refer to the Warmup Idle section.	
Idle Settings	Timers > Engine Logic	[Menu]		



Name	Parent Menu	Range	Default	Description
Cooldown Idle	Timers > Engine Logic	Disable Enable	Disable	Idle during cooldown.
Auto Idle Link	Timers > Engine Logic	Disable Breaker Trip	Disable	<p>If set to breaker trip, the breaker trip will be activated whenever the controller is in the Idle Mode. The breaker trip will be turned off when Idle Mode is exited if it was not in the latched state.</p> <p>If the user de-latches the breaker trip output while Auto Idle is active, the breaker trip will turn off for 1 second and then turn back on.</p>

Idle Switched Output

A switched output can be set to Idle to turn on whenever Idle Mode is entered. This is useful for electronic governors that have an idle input to tell the governor to run the engine at idle speed. Note that the switched outputs are meant to drive relays, so a relay must be installed to do the logic for the governor.

4.5.1.4.1 Warmup Idle

This section explains the Warmup Idle functionality.

The Warmup Idle is used to run the engine at a reduced speed at engine start.

Name	Parent Menu	Range	Default	Description
Warmup Idle	Timers > Engine Logic	Disable Warm-up Timer Oil Temp. Engine Temp.	Disable	<p>If enabled, the engine is placed in Idle Mode during the warm-up period.</p> <p><u>Warm-up Timer</u> – The engine idles during the duration of the warm-up timer countdown.</p> <p><u>Oil Temp.</u> – The oil temperature over J1939 is used to determine the extent of the Warm-up / Idle period.</p> <p><u>Engine Temp.</u> – Same as Oil Temp. but the engine temperature is used. The engine temperature can come locally or from J1939.</p> <p>The oil temp and engine temp selections use the Debounce, Low Point, and High Point settings below.</p>
Debounce	Timers > Engine Logic > Idle Settings	1 to 10 s, in 1 s increments	10 s	(Warmup Idle) If the temperature remains between the “Low Point” and “High Point” settings for this time, exit the warm-up / idle.



Name	Parent Menu	Range	Default	Description
Low Point	Timers > Engine Logic > Idle Settings	1 to 180 °F, in 1 °F increments	32 °F	(Warmup Idle) Continue to idle when the temperature is below this setting. Ignore the Debounce.
High Point	Timers > Engine Logic > Idle Settings	1 to 180 °F, in 1 °F increments	50 °F	(Warmup Idle) Always exit idle when the temperature is above this setting.

4.5.1.4.2 Idle Inhibit

Use this feature to prevent start up when the Idle Mode switch is active.

Settings (Other Config > Idle Inhibit, in the Configurator Software; these are under the switched inputs when the idle input is enabled)

Name	Parent Menu	Range	Default	Description
Remote Start (Start / Stop Switched Input Inhibit)	Other Config > Idle Inhibit	No Inhibit Inhibit	No Inhibit	Prevent the remote start switch input from starting the engine when the idle switch is active.
Aux Start (Aux 1, 2, 3, 4 Sensor AutoStart Inhibit)	Other Config > Idle Inhibit	No Inhibit Inhibit	No Inhibit	Prevent Auxiliary 1, 2, 3, and 4 sensors AutoStart feature from starting the engine when the idle switch is active.

If the engine is in the Idle Mode because of the [Warmup Idle](#) feature, the remote start (start/stop) and auxiliary sensors AutoStart can still start the engine.

This prevents starting when the Idle switch is active in the Auto Mode. This will also shut down the engine if the idle switched input is activated when the controller is in the delay to start, preheat, cranking, and crank reset states. The main purpose is to prevent a remote start if the idle switch was accidentally left on.

4.5.2 Schedulers

4.5.2.1 Exerciser

The Exerciser function is used to start and run the engine periodically. The following settings configure the Exerciser function.

Exerciser Settings (in the Timers menu)

Name	Range	Default	Description
Enable	Enable Disable	Disable	Enables the exerciser feature.
Delays > Pre-Alarm	1 ~ 20 min	5 min	Amount of time to display a warning before starting the engine.
Delays > Run Time	10 ~ 1500 min	30 min	Amount of time to run the engine.



Name	Range	Default	Description
Schedule > Start Date	1 ~ 31	8	<p>The day of the month for the first exerciser run. This setting is only used to set the first exerciser run. All subsequent exerciser runs use the Repeat Days setting to determine when they should run.</p> <p>If the date and time selected has already gone by for the current month, then the exerciser will be started on the given date in the next month. Also, if the date has not yet occurred, but the current month does not have that date (for example, it is February 21 and a date of 31 has been selected), then the exerciser will run in the next month to have that date (March 31).</p>
Schedule > Start Hour	0 ~ 23	12	<p>The time of day for the exerciser run. If the “Pre-Alarm” setting above is non-zero, then this setting indicates when the pre-alarm warning countdown will begin. The controller will start after the pre-alarm countdown is finished.</p>
Schedule > Repeat Days	1 ~ 28 days	14	<p>Number of days between each exerciser cycle. This setting is applied to all subsequent exerciser starts after the first start.</p>



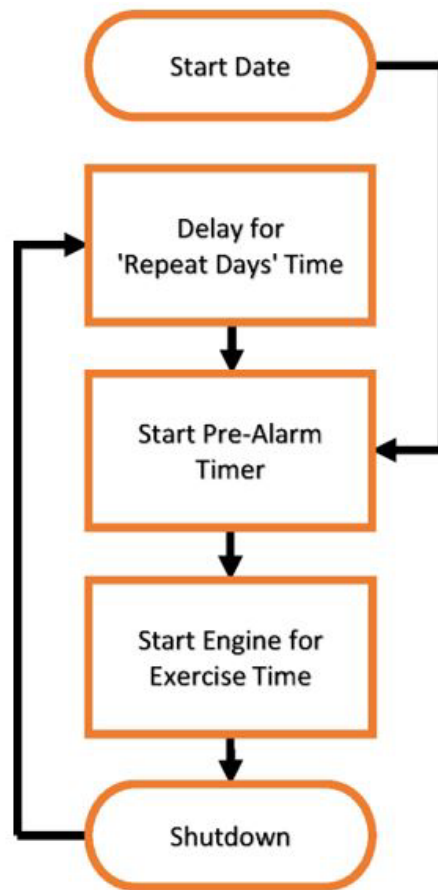

Exerciser Sequence

If the controller is in the Off Mode, if the emergency stop is activated, or if the start inhibit is active, then the exerciser will not run. The event “Bypass Exerciser” will be logged in the Events History and the exerciser will run again at the next scheduled time as determined by the “Repeat Days” setting.

4.5.2.2 Week Scheduler

The weekly scheduler allows up to 16 unique weekly exercise times to be created. By default, all schedulers are disabled.

Timers > Week Scheduler

Name	Range	Description
Weekday	Sunday ~ Saturday	The day of the week on which the exercise will take place.
Start time	24-hour clock in 1 min increments	The time at which the exercise should start on the given day. At the selected time, a one-minute pre-alarm is displayed on the LCD screen. The controller starts after this one-minute period.
Run time	10 ~ 1440 min in 1 min increments	The duration of the exercise run period. Up to one day.



When entering the Week Scheduler menu, there will be 16 sub menu items, each corresponding to one of the 16 weekly exercise times. If disabled, the entry will have dashed lines, as shown here: “-----”. If enabled, the day of week, start time, and duration will be displayed for the menu. Pressing Enter will enter the sub menu for that exerciser time.

It is recommended that the RapidCore Configurator Software be used to enter the times as this provides a much more convenient interface, especially if daily exercise times are wanted.

4.5.2.3 Long Time Run

The Long Time Run counter can be used to shut down the controller after a very long period of time. This is useful for remote primary power applications where the user wants to divide run time between two generators. When the countdown expires, the controller will shut down. Long Time Run is only active if the generator was started manually (i.e., by pressing the front RUN button).

Timers > Long Time Run

Name	Range	Default	Description
Start Trigger	Disable Manual Start	Disable	Set to “Manual Start” to enable the Long Time Run feature.
Run Duration	1 ~ 5000 hr in 1 hr increments	1 hr	The amount of time to run before shutting down.

4.5.3 Maintenance

The controller has the ability to count down the time between scheduled maintenance events. Once maintenance is required, the controller will alert the operator via the LCD screen and a switched output (if enabled) wired to a lamp / horn / buzzer. The following settings are used to configure the maintenance timer.

Timers > Maintenance

Name	Range	Default	Description
Reset Counter	Yes or No	----	Once the maintenance count interval expires, use this to reset the time and turn off the switched output (if enabled). Select Yes to reset the counter and exit the menu. Select No to exit the menu without resetting the counter.
Enable Counter	Enable Disable	Disable	Enables or disables the maintenance function.
Count Interval	10 ~ 9990 hr in 5 hr increments	1000 hr	Determines the number of hours between required maintenance. A switched output can be configured to turn on once the count interval expires.

To determine the amount of time until the next scheduled maintenance, follow these menu steps:

Main Menu > Device Info. > Maintenance



The maintenance counter is disabled if “---” is displayed. A negative number indicates the amount of time since the maintenance timer expired.

Note: The maintenance timer displays “Service Required” when this time expires. This message is only displayed the next time the controller enters the Run Mode. If the timer expires when the controller is in the Run Mode, the message is not displayed.

4.6 AC Monitor

The controller has the ability to monitor AC voltage from a generator. The following sections are used to configure settings associated with AC monitoring.

4.6.1 Generator Voltage

The following settings are used to configure the controller’s response to voltage measurements.

AC Monitor > Genset Voltage menu

Name	Range	Default	Description
Voltage Source	Disable 2-Wire Single 3-Wire Single 3-Wire 3-Phase 4-Wire 3-Phase 4-Wire Delta Auto Selection	3-Wire Single	The wiring configuration of the generator. Disable will disable AC voltage and AC frequency sensing and display. <u>2-Wire Single</u> : One 120 VAC L-N. Use phase A. <u>3-Wire Single</u> : 120/240 VAC systems. Use phases A and B. <u>3-Wire 3-Phase</u> : Three phase delta without a ground. <u>4-Wire 3-Phase</u> : Three phase Wye system. Center taped ground. <u>4-Wire Delta</u> : Delta with a ground. The high leg is phase B. For example, if A-N and C-N read 120 VAC, then B-N will read 208 VAC. <u>Auto Selection</u> : Selecting Auto Selection will use the Voltage Select switched inputs to determine the wiring configuration. This setting also enables the AC Frequency monitoring and display.
Scaling Factor	0.500 ~ 2.500 in 0.001 increments	1.000	The gain to apply to the AC voltage that is read at the controller. See below for more information.
Nominal Volts	50 ~ 800 VAC* in 1 VAC increments	240 VAC	Generator line-to-line voltage output when operating under normal running conditions.
Auto Nominal > 1Ph 3-Wire (1-Phase 3-Wire)	50 ~ 800 VAC* in 1 VAC increments	240 VAC	Nominal Volts when using the Voltage Select inputs.



Name	Range	Default	Description
Auto Nominal > 3-Phase (1)	50 ~ 800 VAC* in 1 VAC increments	208 VAC	
Auto Nominal > 3-Phase (2)	50 ~ 800 VAC* in 1 VAC increments	480 VAC	
Auto Nominal > 3-Phase (3)	50 ~ 800 VAC* in 1 VAC increments	600 VAC	
Auto Scaling > 1Ph 3-Wire (1-Phase 3-Wire)	0.500 ~ 2.500 in 0.001 increments	1.000	Scaling Factor when using the Voltage Select inputs.
Auto Scaling > 3-Phase (1)	0.500 ~ 2.500 in 0.001 increments	1.000	
Auto Scaling > 3-Phase (2)	0.500 ~ 2.500 in 0.001 increments	1.000	
Auto Scaling > 3-Phase (3)	0.500 ~ 2.500 in 0.001 increments	1.000	
Auto Single	A-C Phase A-B Phase	A-B Phase	For 1-Phase 3-Wire when using the Voltage Select inputs. This determines the phases from which the single-phase voltage is read.
Setpoints > Low Warn	50 ~ 99% in 1% increments	90%	Reading at which a warning occurs.
Setpoints > Low Fail	50 ~ 99% in 1% increments	85%	Reading at which a failure occurs.
Setpoints > High Warn	101 ~ 150% in 1% increments	110%	Reading at which a warning occurs.
Setpoints > High Fail	101 ~ 150% in 1% increments	115%	Reading at which a failure occurs.

	CAUTION
	* 800 VAC APPLIES TO SOFTWARE LOGIC ONLY. DO NOT EXCEED 600 VAC ON THE AC VOLTAGE TERMINALS INCLUDING DURING OVER VOLTAGE WARNING AND FAILURE CONDITIONS.

	ATTENTION
	* 800 VCA NE S'APPLIQUE QU'A LA LOGIQUE LOGICIELLE. NE DEPASSEZ PAS 600 VCA SUR LES BORNES DE TENSION CA, Y COMPRIS EN SITUATION D'AVERTISSEMENT DE SURTENSION OU DE DEFAILLANCE.



Application Note: Scaling Factor

The scaling factor setting can be used to calibrate the AC voltage if there are discrepancies between the reading and the actual value. It can also be used if transformers are used to step up / down the voltage. The scaling factor applies to all phases in a system.

Example: The voltage source is a 3-Wire 3-Phase system with a nominal voltage of 208 VAC. The controller is reading 206.3 VAC, but a calibrated multimeter gives 208.3 VAC. Use the formula below to determine the scaling factor.

$$\text{Scaling Factor} = \text{Multimeter Reading} / \text{Controller Reading}$$

$$\text{Therefore, Scaling Factor} = 208.3 \text{ VAC} / 206.3 \text{ VAC}$$

$$\text{Scaling Factor} = 1.010$$

4.6.1.1 AC Voltage Select

The controller has the ability to automatically change its AC sensing (voltage and current) and display configuration through the use of switched inputs. When using voltage select, the controller will continue to monitor the inputs for 10 seconds after crank success. Once that time expires, the controller will then display the selected voltage configuration.

The following must be set:

1. Two switched inputs (Switched I/O > Switched IN X > Function) must be set to the *Volt Select 1* and *Volt Select 2* switch input functions
2. AC Monitor > Genset Voltage > Voltage Source must be set to *Auto Selection*. Rapid Configurator Software note: this option will not appear unless Step 1 is performed

The following table shows the relationship between the switched inputs' status and the voltage configuration.

Volt Select 1 Input	Volt Select 2 Input	Voltage Configuration
Inactive	Inactive	3-Wire Single Phase
Active	Inactive	3-Phase (1)
Inactive	Active	3-Phase (2)
Active	Active	3-Phase (3)

	CAUTION
	BOTH <i>VOLT SELECT 1</i> AND <i>VOLT SELECT 2</i> MUST BE ASSIGNED TO SWITCHED INPUTS. OTHERWISE, THE VOLTAGE SENSING WILL BE DISABLED.

	ATTENTION
	<i>VOLT SELECT 1</i> (SELECTION TENSION 1) ET <i>VOLT SELECT 2</i> (SELECTION TENSION 2) DOIVENT TOUS DEUX ETRE AFFECTES A DES ENTREES COMMUTEES. SINON, LA DÉTECTION DE TENSION SERA DÉSACTIVÉE.

The following settings must be set. All except “Auto Single” are menus that contain four settings corresponding to the Volt Select 1 / Volt Select 2 inputs above.



Name	Volt Select 2 Input
Genset Voltage > Auto Nominal	These settings correspond to the “Nominal Volts” setting under the AC Monitor > Genset Voltage menu.
Genset Voltage > Auto Scaling	These settings correspond to the “Scaling Factor” setting under the AC Monitor > Genset Voltage menu.
Genset Voltage > Auto Single	Only applies when voltage source is set to 1-Phase 3-Wire. This determines the phases from which the single phase voltage is read: A-C or A-B.
Genset Current > Auto Rated	These settings correspond to the “Rated Amps” setting under the AC Monitor > Genset Current menu.
Genset Current > Auto Scaling	These settings correspond to the “Scaling Factor” setting under the AC Monitor > Genset Current menu.

4.6.2 Generator Frequency

Generator AC frequency display on the controller is enabled when the [Voltage Source](#) is not set to Disable.

The following settings are used to configure the controller’s responses to frequency measurements.

Frequency Settings (in AC Monitor > Genset Freq)

Name	Range	Default	Description
Freq. Source	50 Hz System (50 Hz) 60 Hz System (60 Hz) Auto Selection	60 Hz System	This is the wiring configuration of the generator. Selecting Auto Selection will use the RPM / Frequency Select input to determine which frequency is used. This setting is used by the following setpoints. It does not affect the display of AC Frequency.
Setpoints > Low Warn (Under-Frequency Warning)	Disable 20 ~ 99% in 1% increments	90%	Reading at which a warning occurs.
Setpoints > Low Fail (Under-Frequency Failure)	Disable 20 ~ 99% in 1% increments	85%	Reading at which a failure occurs.
Setpoints > High Warn (Over-Frequency Warning)	Disable 101 ~ 150% in 1% increments	110%	Reading at which a warning occurs.
Setpoints > High Fail (Over-Frequency Failure)	Disable 101 ~ 150% in 1% increments	115%	Reading at which a failure occurs.

4.6.2.1 RPM / Frequency Select

The controller has the ability to change between Primary RPM / 60 Hz and Secondary RPM / 50 Hz through the use of a switched input.





The following settings must be set in order for this feature to function.

- Switched I/O > Switched In A/B/C/D/E > Function > RPM Switch (Primary RPM / 60 Hz - Secondary RPM / 50 Hz Select). The switched input is only monitored before a start signal has been received. Once a start signal has been received, changing the status of the switched input will have no effect
- AC Monitor > Genset Freq. > Freq. Source > Auto Selection
- Sensors > Engine Speed > RPM Switch > Primary (Primary RPM / 60 Hz)
- Sensors > Engine Speed > RPM Switch > Secondary (Secondary RPM / 50 Hz)

The following table shows the relationship between the switched input status and the RPM / Frequency.

Switched Input	Speed / Frequency
Inactive	Primary RPM / 60 Hz
Active	Secondary RPM / 50 Hz

	CAUTION
	IF ENABLED, THE J1939 TSC1 PGN WILL BE BROADCASTED ACCORDING TO THE SELECTED SPEED. OTHERWISE, ONLY THE WARNING AND FAILURE SETPOINTS ARE AFFECTED BY THIS FUNCTION.

	ATTENTION
	S'IL EST ACTIVE, LE PGN J1939 TSC1 SERA DIFFUSE SELON LA VITESSE SELECTIONNEE. DANS LE CAS CONTRAIRE, SEULS LES POINTS DE CONSIGNE D'AVERTISSEMENT ET DE DEFAILLANCE SONT AFFECTES PAR CETTE FONCTION.

4.6.3 Generator Current

The following settings are used to configure the controller's responses to current measurements.

AC Monitor > Genset Current

Name	Range	Default	Description
Current Source	Enable Disable	Enable	Enables or disables current metering.
Turns Ratio	5 ~ 5000 A : 5 A in 5 A increments	100 A : 5 A	The turns ratio of the current transformers.
Scaling Factor	0.500 ~ 1.250 in 0.001 increments	1.000	Scaling factor at which the current is read into the controller. See below for more information.
Rated Amps	5 ~ 5000 A in 1 A increments	100 A	Maximum current draw that the generator can provide when operating under normal running conditions.
Auto Rated > 1Ph 3-Wire	5 ~ 5000 A in 1 A increments	100 A	Rated Amps when using the Voltage Select inputs.



Name	Range	Default	Description
Auto Rated > 3-Phase (1)	5 ~ 5000 A in 1 A increments	100 A	
Auto Rated > 3-Phase (2)	5 ~ 5000 A in 1 A increments	100 A	
Auto Rated > 3-Phase (3)	5 ~ 5000 A in 1 A increments	100 A	
Auto Scaling > 1Ph 3-Wire	0.500 ~ 2.500 in 0.001 increments	1.000	Scaling Factor when using the Voltage Select inputs.
Auto Scaling > 3-Phase (1)	0.500 ~ 2.500 in 0.001 increments	1.000	
Auto Scaling > 3-Phase (2)	0.500 ~ 2.500 in 0.001 increments	1.000	
Auto Scaling > 3-Phase (3)	0.500 ~ 2.500 in 0.001 increments	1.000	
Dummy Load	[Menu]	See the Dummy Load section.	
Basic Alarm	[Menu]	See the Basic Alarms section.	
IDMT Protect	Disable Breaker Trip Shutdown Trip	See the IDMT section.	
IDMT Settings	[Menu]		
Imbalance Mode	Disable Breaker Trip Shutdown Trip	See the Load Imbalance section.	
Imbalance Set	[Menu]		
Break Trip Fail	Disable Enable	Disable	Shuts down the generator if the generator circuit breaker fails to trip. If the 45 switched output is active - due to IDMT or Load Imbalance - and if after 10 seconds the measured generator current is still above 10% of the Rated Current, the generator will shut down.

4.6.3.1 Basic Alarms

The controller can give a warning and/or shut down on over current. If [IDMT](#) is enabled, then it overrides the High Failure shutdown, but the warning is still active.



AC Monitor > O.C. Protection > Basic Alarm



Name	Range	Default	Description
High Warn	Disable 1 ~ 125% in 1% increments	110%	Reading at which a warning occurs.
High Fail	Disable 1 ~ 125% in 1% increments	115%	Reading at which a failure occurs.

Percentages are based on the Rated Amps setting. The warning and failure setpoints apply to each phase separately and not to the sum of the phases.

4.6.3.2 IDMT

IDMT sets an inverse time trip curve for over-current. When set, this overrides the [Over-Current Failure](#).

AC Monitor > O.C. Protection

Name	Range	Default	Description
IDMT Protect	Disable Breaker Trip Shutdown Trip	Disable	<u>Disable</u> : Disables the IDMT feature. <u>Breaker Trip</u> : If IDMT is active, the 45 switched output is activated to switch off the main generator breaker. This is a latching feature. The operator must press the  (up) and  (down) keys to reset the feature. <u>Shutdown Trip</u> : Shuts down the engine.
IDMT Settings > TDS Const (Time Dial Setting)	0.1 ~ 30 in 0.1 increments	0.3	Sets the slope of the IDMT curve. This controls the sensitivity of the trip to over current.
IDMT Settings > IDMT Reset	1 ~ 600 s in 1 s increments	200 s	How long the current must drop and stay below the rated current to reset the IDMT.

The equation for the IDMT is given as:

$$(t_r)_m = \frac{TDS * 13.5}{\frac{I}{I_s} - 1}$$

where

TDS is the time dial setting above

I_s is the [Rated Current](#) (in A)

I is the actual current measured by the controller (in A)

$(t_r)_m$ is the trip time (in seconds)





For example, with a Rated Current of 100 A and a TDS of 0.1, the IDMT will trigger in:

- 0.15 seconds if the actual generator current is 1000 A
- 1.35 seconds if the actual generator current is 200 A
- 6.75 seconds if the actual generator current is 120 A

4.6.3.3 Load Imbalance

Load imbalance provides protection against differences in phase currents.

AC Monitor > O.C. Protection

Name	Range	Default	Description
Imbalance Mode	Disable Trip Only Shutdown Trip	Disable	<u>Disable</u> : Disables the Load Imbalance feature. <u>Trip Only</u> : If Load Imbalance is active, the 45 (RapidCore name) switched output is activated to switch off the main generator breaker. This is a latching feature. The operator must press the  (up) and  (down) keys to reset the latch. <u>Shutdown Trip</u> : Shuts down the engine.
Imbalance Set > Imbalance	1 ~ 200% in 1% increments	10%	The percentage of rated current that any phase must exceed the other phases by to trigger a load imbalance.
Imbalance Set > Debounce	1 ~ 600 s in 1 s increments	10 s	The length of time to allow an imbalance before triggering (trip, shutdown).

The load imbalance formula is given as:

For three-phase:

$$\max\{|I_A - I_B|, |I_A - I_C|, |I_B - I_C|\} > \text{Rated Amps} \times \text{Phase Imbalance Threshold (\%)}$$

For single-phase:

$$|I_1 - I_2| > \text{Rated Amps} \times \text{Phase Imbalance Threshold (\%)}$$

where

$I_A, I_B, I_C, I_1,$ and I_2 are the actual currents measured by the controller

Note: Phase Imbalance is the same as load imbalance.



4.6.3.4 *Dummy Load*

The dummy load feature can be enabled to prevent wet stacking.

AC Monitor > Genset Current > Dummy Load

Name	Range	Default	Description
Bypass Time	Disabled 1 ~ 120 s in 1 s intervals	Disabled	The amount of time to delay before applying the dummy load.
Load On	Disabled 1 ~ 500 A in 1 A increments	Disabled	The threshold below which the dummy load is applied. There is a 4 second debounce time. The bypass time must expire before the load is applied. All phases must drop below this threshold to trigger the dummy load.
Load Off	Disabled 1 ~ 500 A in 1 A increments	Disabled	The threshold above which the dummy load is removed. The dummy load is turned off if one phase rises above this threshold.

One of the [Switched Outputs](#) must also be set to dummy load. The output is only turned on when the engine is running.

4.6.3.5 *EPS Supplying Load*

The EPS (Emergency Power System) Supplying Load sets a flag in Modbus register 40006 to indicate to the Cattron RA400 remote annunciator that the generator is actively supplying power. If this flag is set, the RA400 will light its EPS Supplying Load indicator. This is used to meet NFPA110 requirements.

If the actual current measured on any one phase of the generator is above 5% of the AC over current warning set point, then the EPS Supplying Load flag is set. For more information on this register, refer to the TOUGH Series Modbus Reference Manual or the RA400 manual.

4.7 Communications

The controller has the ability to communicate with other systems over communication buses. The following sections relate to settings associated with communications.

4.7.1 CANbus (J1939)

This page gives a very short overview of J1939 support (electronic engines). For detailed information about J1939 and all related settings, please refer to the J1939 Reference Manual, which can be found at www.cattron.com.



Name	Range	Default	Description
ECM Model	Generic J1939 John Deere JDEC Volvo EMS This is not a complete list; see the J1939 Reference Manual for the full list.	Generic J1939	Choose one of the compatible ECM modules from the list.
ECM Communication Failure	Enable Disable	Disable	If no CAN messages are received for more than 6 seconds, the controller shuts down the engine.
DTC Display	Disable Global Enable Running Enable	Disable	Enables or disables active fault messages (DM1) monitoring.
Active DTC Log	Enable Disable	Disable	Enables or disables the storing of active faults (DM1).
Read Stored DTC	Enable Disable	Disable	Enables or disables the ability to request stored fault codes from the ECM (DM2).
Auto Power ECM	Enable Disable	Disable	When enabled, the fuel relay is enabled in Auto Mode so that the ECM is already booted up and initialized before the user decides to start the engine.
ECM Power Delay	5 ~ 30 s in 1 s increments	10 s	Used in conjunction with Auto Power ECM. When the engine shuts down, the controller waits for the time specified by the ECM Power Delay before turning on the fuel relay. This prevents unwanted start-ups due to the engine not being completely shut down.
Cummins PGNs	Disable Sending Enable	Sending Enable	Enables or disables the broadcasting of PGNs required by some Cummins engines.
SPN Conversion	Version 1 Version 2 Version 3	Version 3	Select the SPN conversion method.
EMS2B Frequency Select	Primary Secondary	Primary	For Volvo EMS2B Engine Control Modules only.
EMS2B Accelerator Pedal	40.0 ~ 60.0% in 0.1% increments	50.0 %	For Volvo EMS2B Engine Control Modules only.



4.7.2 Modbus (RS485)

The Modbus functionality on the controller provides interface ability to PLCs, SCADA and building management systems. For detailed information about the Modbus registers and their interpretations, please refer to the TOUGH Series Modbus Reference Manual, which can be found at www.cattron.com.

It uses the Modbus RTU communication protocol and is configured as a slave only.

Name	Range / Values	Default	Description
Device Address	1 ~ 247 in 1 increments	1	The device address of the controller.
Baud Rate (BPS)	9600, 19200, 38400, 57400	9600	The speed at which the controller (slave) communicates with the master.

4.8 Other Config

This section contains miscellaneous settings.

4.8.1 Password

A password is required to change certain settings. The Password menu is used to change this password and to control if and when the user is prompted for a password.

Other Config > Passcode

Name	Range	Default	Description
Bypass	Disable or Enable	Disable	If enabled, a password is not required to change settings.
Timeout	0 ~ 120 min in 1 min increments	10 min	How long after the password is entered before the user is required to enter it again. The timeout is implemented as a simple countdown timer. The following apply: <ul style="list-style-type: none"> • If the bypass time is changed, this new bypass time will not be loaded until the countdown timer has expired and the user enters the password. • The countdown timer is stored in non-volatile memory and is “paused” when the controller is powered off. The counter will resume when the controller is powered on again. • Any button press in the menu will reset the timer.
Passcode	0000 ~ 9999	0000	The four numeric digits that make up the password.

4.8.2 Settings Name / ID

If you are storing settings from the RapidCore Configurator Software, a custom name can be entered to allow users to determine the settings that are stored in the controller. This custom name, called “Configuration Name” (ID in the controller), is found under Options in the settings tab of the Configurator Software. There is no controller menu to set this ID. It can be up to 12 characters long.



The Configuration Name can be viewed in the Device Info > About TG410/TG350 menu. It is labeled ID.

4.8.3 Process Control

The Process Control feature has two different control methods: Main-In and Main-Out. The Main-In maintains a reservoir/pressure level by controlling the flow of fluid/gas into the reservoir/tank. The Main-Out maintains a reservoir/pressure level by controlling the flow of fluid/gas from the reservoir/tank. It does this by regulating the speed of the engine over the J1939 CANbus.

The process control feature takes over on an engine start once the engine has ramped up to the goal speed (after going through the idle and intermediate ramping).

The controller reads the sensor value from selected Auxiliary Sensor input (1, 2, 3 or 4) or Transducer Input (Aux 5), compares the input value with the set-point, and then, based on an algorithm, increments or decrements the speed (RPM) by a certain amount (controlled by the Gain and Delay settings) to maintain the desired set-point outside of the deadband area. Control pauses inside the deadband area. If the sensor input goes beyond a minimum or maximum value, the algorithm will pause, and the RPM will be maintained at a minimum or maximum value.

The algorithm is a fuzzy logic type control with a deadband and a minimum / maximum saturation. The user sets the aggressiveness of the control with the *Gain* setting and the response time of the control with the *Delay* setting.

Front Panel: Other Config > Process Control menu, or

RapidCore: Pumping Applications > Closed Loop Control

Name	Range	Default	Description
Closed Loop > System (Control Type)	Disabled Main-In (Maintain In) Main-Out (Maintain Out)	Disabled	Main-In controls the level when pumping fluid into a reservoir. Main-Out controls the level while pumping fluid out of the reservoir.
Closed Loop > Sensor In (Sensor Input)	AUX-1 AUX-2 AUX-3 AUX-4 AUX-5	Aux-5	The Auxiliary Sensor Input function that is providing feedback on the reservoir level. Aux-5 refers to the Transducer under the Application menu.
Closed Loop > Delay	1 ~ 30 s in 0.1 s increments	8.0 s	The sampling time of the control algorithm. This value must be tuned for each installation.
Closed Loop > Gain	1 ~ 30 in 0.1 increments	19.0	The amount to increment or decrement the RPM when the sensed value is outside of the deadband. This number does not represent an actual RPM. A larger gain will generate a larger RPM change than a smaller gain for the same size error. This value must be tuned for each installation.



Name	Range	Default	Description
Setpoints > Main-In (Maintain In Setpoint)	1 ~ 900 in 0.1 increments	300.0	The level set-point to attempt to maintain. Only applies if the Control Type is set to Maintain-In. This value takes on the units of the Aux sensor set in the Closed Loop > Sensor In menu.
Setpoints > Main-Out (Maintain Out Setpoint)	1 ~ 900 in 0.1 increments	500.0	The level set-point to attempt to maintain. Only applies if the Control Type is set to Maintain-Out. This value takes on the units of the Aux sensor set in the Closed Loop > Sensor In menu.
Setpoints > Deadband+ (High Deadband)	1 ~ 30 in 0.1 increments	3.0	The high limit of the deadband.
Setpoints > Deadband- (Low Deadband)	1 ~ 30 in 0.1 increments	3.0	The low limit of the deadband.
Thresholds > High Edge (High Limit)	1 ~ 900 in 0.1 increments	700.0	The high saturation. The maximum level at which the RPM control is fixed. This value takes on the units of the Aux sensor set in the Closed Loop > Sensor In menu.
Thresholds > Low Edge (Low Limit)	1 ~ 900 in 0.1 increments	100.0	The low saturation. The minimum level at which the RPM control is fixed. This value takes on the units of the Aux sensor set in the Closed Loop > Sensor In menu.
Thresholds > Max RPM (Max Limit RPM)	500 ~ 4000 RPM in 1 RPM increments	3200 RPM	The fixed RPM that should be used when the level rises above the High Edge.
Thresholds > Min RPM (Low Limit RPM)	500 ~ 4000 RPM in 1 RPM increments	1000 RPM	The fixed RPM that should be used when the level falls below the Low Edge.



5 Troubleshooting

If you are having issues with your controller, please refer to the following table for a solution before contacting Cattron at www.cattron.com.

Issue	Solution
Engine starts but the crank output does not turn off	<p>The controller is not receiving a speed signal.</p> <ul style="list-style-type: none"> • Verify the Sensors > Engine Speed > Signal Source setting is set correctly. • Verify the Timers > Engine Logic > RPM Disconnect setting is set correctly. • Ensure the correct wiring to the controller. For magnetic pickup, Speed Sensing A and B terminals are used. For generator voltage, the AC voltage connections are used.
Sensor always displays its lowest or highest value	<p>The sensor could either be open (not connected) or shorted to ground. Verify your connections and ensure the correct sender table is loaded.</p>
Sensor value acts erratically, bounces, or climbs on engine start-up	<p>This could be caused by one of the following:</p> <ul style="list-style-type: none"> • Bad ground between sensor and controller. Check that there is a good ground between the negative post on the battery and the battery negative terminal (J4-3) on the controller. Also check that the connection from the negative post on the battery to the sensor body is good; if not, then add a grounding wire close to the sensor. • The ground strap is not sufficient AWG. Ensure the ground and power wiring can carry the large amperage for the starter motor and other equipment. • If you are using a magnetic pickup sensor for speed sensing, it might be generating noise. Use a shielded twisted pair cable from the magnetic sensor to the controller. Refer to the typical wiring diagram for how to do this. • Try twisted pair cable running both ground and the signal; ground it near the sensor body. Try an isolated sensor (sensor having both a ground post and a signal post).
Controller displays “Failure To Stop” on a shutdown.	<p>Either set Energize to Stop under Timers to 0 seconds or increase its duration. At the end of the Energize to Stop time, the controller will detect if the engine speed is zero. If it is not, it goes into a “Failure To Stop” failure.</p>



6 Technical Support

For remote and communication control systems support, parts and repair, or technical support, visit us online at:
www.cattron.com/contact.



Due to continuous product improvement, the information provided in this document is subject to change without notice.

Cattron Wireless Automation and Control Solutions Support

For remote and communication control systems support, parts and repair, or technical support, visit us online at:
www.cattron.com/contact

Cattron North America Inc., 655 N River Rd NW, Suite A, Warren, OH 44483