

# GENERAC®

---

## POWER SYSTEMS, INC.

# Operator's Manual

## "E" Option Control Panels

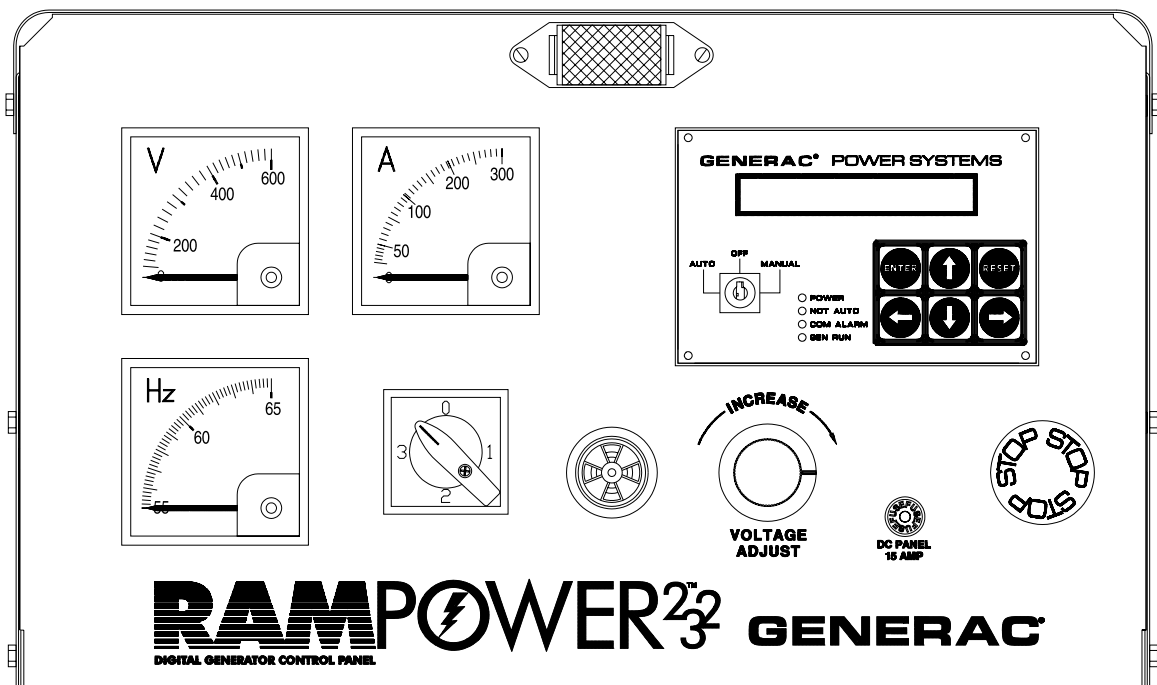



## Important Safety Instructions

### E Option Control Panels

**⚠ SAVE THESE INSTRUCTIONS – The manufacturer suggests that these rules for safe operation be copied and posted in potential hazard areas. Safety should be stressed to all operators and potential operators of this equipment. ⚠**

Study these SAFETY RULES carefully before installing, operating or servicing this equipment. Become familiar with this manual and all literature pertaining to your generator set and related equipment. This equipment can operate safely, efficiently and reliably only if it is properly installed, operated and maintained. Many accidents are caused by failing to follow simple and fundamental rules or precautions.

Generac cannot possibly anticipate every possible circumstance that might involve a hazard. The warnings in this manual, and on tags and decals affixed to your equipment are, therefore, not all-inclusive. If you use a procedure, work method or operating technique Generac does not specifically recommend, you must satisfy yourself that it is safe for you and others. You also must make sure the procedure, work method or operating technique that you choose does not render the equipment unsafe.

### **⚠ GENERAL HAZARDS ⚠**

- For safety reasons, Generac recommends that this equipment be installed and serviced by a Generac Authorized Service Dealer or other competent, qualified electrician or installation technician who is familiar with applicable codes, standards and regulations. The operator also must comply with all such codes, standards and regulations.
- When working on this equipment, remain alert at all times. Never work on the equipment when you are physically or mentally fatigued.
- Inspect the equipment regularly, and promptly repair or replace all worn, damaged or defective parts using only factory-approved parts.
- Before performing any maintenance on the generator or any related equipment, disconnect the generator's battery cables to prevent accidental start-up. Disconnect the cable from the battery post indicated by a NEGATIVE, NEG or (-) first. Reconnect that cable last.

### **⚡ ELECTRICAL HAZARDS ⚡**

- Generators produce dangerous electrical voltages and can cause fatal electrical shock. Avoid contact with bare wires, terminals, connections, etc., while the generator and related equipment are running. Ensure all appropriate covers, guards and barriers are in place before operating the equipment. If you must work around an operating unit, stand on an insulated, dry surface to reduce shock hazard.

- Do not handle any kind of electrical device while standing in water, while barefoot, or while hands or feet are wet. DANGEROUS ELECTRICAL SHOCK MAY RESULT.
- If people must stand on metal or concrete while installing, operating, servicing, adjusting or repairing this equipment, place insulative mats over a dry wooden platform. Work on the equipment only while standing on such insulative mats.
- Wire gauge sizes of electrical wiring, cables and cord sets must be adequate to handle the maximum electrical current (ampacity) to which they will be subjected.
- Before installing or servicing this equipment, make sure that all power voltage supplies are positively TURNED OFF at their source. Failure to do so will result in hazardous and possibly fatal electrical shock.
- When installed with an automatic transfer switch, the generator may crank and start anytime without warning. To prevent injuries cause by sudden start-up, disable the generator's automatic start circuit before working on or around the unit. Then, place a "Do Not Operate" tag on the generator control panel and on the transfer switch.
- In case of accident caused by electric shock, immediately shut down the source of electrical power. If this is not possible, attempt to free the victim from the live conductor. AVOID DIRECT CONTACT WITH THE VICTIM. Use a nonconducting implement, such as a rope or board, to free the victim from the live conductor. If the victim is unconscious, apply first aid and get immediate medical help.
- Never wear jewelry when working on this equipment. Jewelry can conduct electricity resulting in electric shock, or may get caught in moving components causing injury.

### **🔥 FIRE HAZARDS 🔥**

- For fire safety, the generator and related equipment must be installed and maintained properly. Installation always must comply with applicable codes, standards, laws and regulations. Adhere strictly to local, state and national electrical and building codes. Comply with regulations the Occupational Safety and Health Administration (OSHA) has established. Also, ensure that the equipment is installed in accordance with the manufacturer's instructions and recommendations. Following proper installation, do nothing that might alter a safe installation and render the unit in noncompliance with the aforementioned codes, standards, laws and regulations.

**Safety Rules .....Inside Front Cover**

**General Information .....2**

OVERVIEW..... 2

ENGINE CONTROL .....2

E OPTION CONTROL MODULE .....2

    Overview .....2

    Keypad 3

    Display3

        – Software Version Page.....3

        – Generator Command Page .....3

        – Generator Status Page .....3

        – Alarm Status Message Page .....3

        – Alarm Log Page.....4

        – Instrumentation Page .....4

        – Parameter Entry Page .....4

ALARMS..... 4

ALARM PROCESSING .....5

    Input Alarm Functions .....5

        – Alarm Active .....5

    Alarm Type .....6

        – Status .....6

        – Warning – Non-Latched.....6

        – Alarm – Latched .....6

        – Shutdown .....6

        – Alarm Status .....6

        – Alarm Message .....6

    Other Alarms .....6

        – Overcrank.....6

        – Coolant Level .....6

PROGRAMMABLE PARAMETERS .....6

    Preheat Enabled .....6

    Preheat Time .....6

    Start Time.....7

    Pause Time .....7

    Start Attempts.....7

    Starter Disengage Speed .....7

    Hold Off Time .....7

    Cool-down Time .....7

    Load Accept Voltage and Frequency .....7

    Warm-up Time .....7

    Flywheel Teeth.....7

    User-defined Output Functions .....7

    Analog Input Scaling Factors.....7

    Analog Input Messages .....7

    Analog Input Alarm Messages .....8

    Analog Input Alarm Settings .....8

    Digital Input Alarm Settings .....8

    Oil Pressure Alarms .....8

    Oil Temperature Alarms .....8

    Coolant Temperature Alarms .....8

    Battery Voltage Alarms .....8

    Engine Speed Alarms .....8

    Generator Voltage Alarms .....8

    Generator Frequency Alarms .....8

    Fuel Level Alarms .....8

    Serial Communications.....8

        – Serial Communication  
            Via Modem.....8

        – Remote Annunciator Panel .....9

        – Altering the Serial  
            Communications Setup .....9

    User Password .....9

ADDITIONAL PANEL COMPONENTS .....9

    AC Voltmeter .....9

    AC Ammeter .....9

    Frequency Meter .....9

    Line-phase Selector Switch .....9

    Voltage Adjust Potentiometer.....10

    Alarm Horn.....10

    DC Panel Fuse .....10

    Emergency Stop Switch .....10

CHECKING/REPLACING THE E PANEL  
CONTROL MODULE INTERNAL FUSE .....10

**Notes .....11**

**Appendix 1 – Glossary.....12**

E CONTROL PANEL DEFINITIONS .....12

**Appendix 2 – Operation .....13**

OUTPUT FUNCTION TABLE .....13

E PANEL MASTER CONTROL BOX  
CONFIGURATION SETTINGS .....14

    Standard Alarm Configuration Menu .....14

    Engine Configuration Menu.....14

    User Configuration Menu .....15

E PANEL DISPLAY MAP.....16

**Appendix 3 – Electrical Data .....18**

**Appendix 4 – Exploded Views and  
Parts Lists .....22**

**AUTHORIZED SERVICE  
DEALER LOCATION**

To locate the GENERAC AUTHORIZED SERVICE  
DEALER nearest you, please call this number:

**1-800-333-1322**

DEALER LOCATION INFORMATION  
CAN BE OBTAINED AT THIS NUMBER.

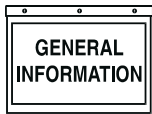

## OVERVIEW

The “E” option control panel is a programmable engine control and monitoring system. It allows the user to customize the generator starting and running sequence, monitor engine parameters and configure the alarms. This can be done either through its own control module, featuring liquid-crystal display (LCD) and keypad, or using a PC and RS232 serial communications. The module includes user programmable inputs and outputs that allow it to be tailored to a vast range of applications. All of the setup information is stored in nonvolatile (permanent) memory.

## ENGINE CONTROL

The module has a three-position selector switch that selects between “Auto” mode, “Off” and “Manual” start mode. When the switch is in the OFF position, the generator will not start, and it will stop if it is running. When the switch is turned to MANUAL, the generator will start immediately and will continue to run until the switch is turned to the OFF position or a shutdown alarm is activated. With the switch in the AUTO position, the generator will wait for either the remote start contacts to close or for a start command to be sent from the serial link. The generator will run until the remote start contacts open, a stop command is sent down the serial link, a shutdown alarm is activated or the switch is turned to the OFF position. The remote start contacts always will have priority over the serial link commands so that the serial link cannot stop the generator if the remote start contacts are closed. When GenLink™ software, which may be obtained from a Generac Authorized Service Dealer, is connected to the E panel via a modem, the panel will monitor the connection to ensure that the line has not dropped. If the E panel detects that the line has been dropped, it will disconnect the modem so that it is ready for another incoming call. If the generator had been started via the modem connection, then it will be stopped immediately unless the remote start contacts are closed or the generator is in manual. However, if the GenLink software disconnected cleanly (as a result of a user command) with the generator running, then the generator will continue to run for another three hours unless it receives a stop command.

When a start command is received, the engine preheat will be engaged if it is selected. The user can program the preheat to engage for a programmable time before engaging the starter motor, to engage while the engine is attempting to start, or to do both. In order to protect the engine from trying to start while it is already running (if the rpm sensor is damaged), an alarm is generated if there is oil pressure when the start command is sent. An alarm also is generated if there is a voltage output from the generator but the rpm sensor detects zero engine speed.

The user can program the length of time that the starter motor is engaged during a start attempt. After the first attempt, the generator will pause for a programmable length of time before the next attempt. The number of attempts also is programmable, after which the failed to start alarm is activated.

The user can program a warm-up time that is active after the generator has started. This could be used in conjunction with a programmable relay output to inhibit the transfer switch from applying load until the generator is ready. The warm-up time can be set to zero if this function is not required. This timer is separate from the alarm hold off timer, which allows the generator to run for a time before certain alarms (such as low oil pressure) are active.

If the generator is in the AUTO mode and a stop command is received, a programmable cool-down timer can be used to keep the generator running with no load for a fixed time. This also can work in conjunction with a relay output to inhibit the transfer switch. If the timer is set to zero, this function is disabled. If the selector switch is turned to OFF, then the generator will stop immediately without waiting for the cool-down time.

Certain alarm functions are designated as shutdown alarms. These alarms will stop the generator and inhibit it from starting until the alarm condition has cleared and the alarm has been reset.

## E OPTION CONTROL MODULE

### ◆ OVERVIEW

The LCD on the front of the module (Figure 1) features a 24-character by two-line display screen that will show one of seven pages. There is a keypad with six keys that are used for operating the display and selecting the various pages. A key-activated switch allows the user to select whether the generator is in the “Auto” mode, “Off” mode or “Manual” run mode. Four LEDs indicate the following conditions:

- “Power” – Battery power is OK.
- “Not Auto” – The generator is not in the automatic mode.
- “Com Alarm” – A common alarm condition has occurred.
- “Gen Run” – The generator is running.

#### NOTE:

**The “Power” LED will go out immediately if the battery voltage dips below the alarm limit, but the alarm will not be triggered unless the voltage is low for more than five minutes.**

Figure 1 – Control Module Layout

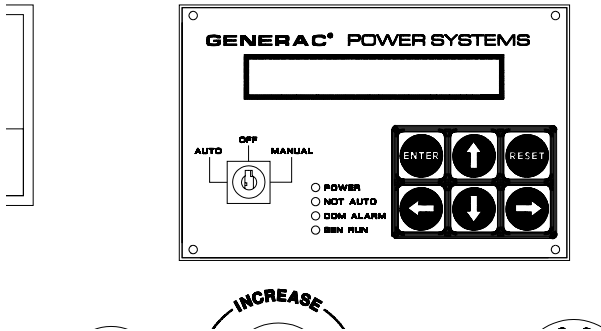

### ◆ KEYPAD

The keypad consists of six keys labeled as follows: ↑ (up), ↓ (down), ← (left), → (right), Enter, and Reset. The left and right arrow keys are used to select the different pages on the display. The up and down arrow keys are used to scroll between options within a page. They also are used for selecting characters when the user is entering messages or parameters for the alarms. The left and right arrow keys move the cursor when the user is entering data. The enter key takes the user into a page on the display to change data (when applicable) and also accepts data that has been entered. It also is used to accept an alarm. The reset key ignores data that has been entered and returns the original value. It also is used to return from the parameter entry mode once the user has finished changing the data, and to reset any latched alarms that have cleared.

### ◆ DISPLAY

The display is organized into a series of pages, each page displays information about the status of the generator. For example, the “Alarm Status Message Page” displays the highest priority current alarm or status condition. The user will be able to scroll between the pages using the left and right arrow keys. Certain actions also cause the display to change pages, e.g., when an alarm becomes active, the display automatically will go to the alarm status page and display the alarm message.

The back light for the display is normally off. If the user presses any key, the back light will come on automatically and remain on for five minutes after the last key was pressed. It also will come on if any status message is current, which means the display will switch to the alarm status page. The back light will flash when an alarm or shutdown message is active, and the audible alarm will sound.

When the display is showing certain pages, the user is able to scroll between relevant items within the page using the up and down arrow keys. For example, if the display is showing the “Alarm Log Page,” the user can use the up and down arrow keys to scroll between the entries on the alarm log. A description of each page is given below.

#### ◆ Software Version Page

This page displays the software revision. Pressing the enter key in this page will perform a display and LED test.

#### ◆ Generator Command Page

This page displays the command sent to the generator. The possible commands are as follows:

- Generator switched off
- Generator in manual mode
- Generator in auto mode – stop command
- Generator in auto mode – remote run command
- Generator in auto mode – serial link run command

#### ◆ Generator Status Page

This page displays the current status of the generator. Options will be as follows:

- Stopped – ready to run
- Stopped – start inhibit active
- Pre-heating (with timer counting down)
- Attempting to start (with timer counting down and number of attempts)
- Pausing before start attempt (with timer counting down and number of attempts)
- Started – running up to speed
- Warming up
- Ready to accept load
- All alarms enabled
- Cooling down
- Stopping
- Stopped due to alarm

If the user has not pressed a key for some time, any change in status will cause this page to be displayed provided that there are no active alarms or status messages from other inputs. If an alarm condition occurs, the alarm status page will be displayed automatically.

#### ◆ Alarm Status Message Page

This page displays alarm messages and programmable status messages. Messages are displayed according to priority, with the shutdown alarms having highest priority, and status messages having lowest priority.

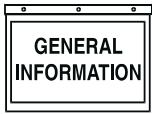

If an alarm becomes active, the display will switch to this page and display the highest priority alarm message. The back light and alarm LED will flash, and the audible alarm will be activated. The user must press the enter key to accept the alarm, at which time the back light will be on continuously. If the alarm is non-latching, the alarm message will clear as soon as the condition is cleared. If the alarm is a latching alarm, then the user must press the reset key to clear the message. Once a message has cleared, the display will show the next priority alarm message.

After an alarm has been accepted, the user is able to scroll through other active alarm and message screens using the up and down arrow keys.

#### ❖ Alarm Log Page

This page displays the last 50 alarm messages. When the user selects this page, it displays the latest alarm message. Pressing the up or down arrow keys will allow the user to scroll up and down the list of messages.

#### ❖ Instrumentation Page

This page displays one of the analog signal values. Pressing the up or down arrow keys will scroll to other analog display screens.

#### ❖ Parameter Entry Page

This page allows the user to modify the various set points and programmable options. See the "Programmable Parameters" section of this manual for more specific option information. The user must press the Enter key when this page is displayed and will then be prompted for a password. The password is a six-digit number and the default value is 000000. However, the user will be able to change the password. Digits will be selected using up and down arrow keys, and the cursor will be moved by the left and right arrow keys. When the user presses the Enter key, the password will be checked. If the password is correct, the display will show one of the data entry screens.

There are four parameter entry menus: "Engine Parameter," "System Alarm," "Digital I/O" and "Analog Input." The user will be able to scroll through the various parameters in each menu using the up and down arrow keys. The left and right arrow keys are used to switch between the four menus. When a parameter that requires changing is displayed, the user presses the Enter key to enable data entry. A cursor will appear at the first character that can be altered. The user can then change the character using the up and down arrow keys. The user can move to the next character or previous character using the left and right arrow keys. Pressing the Enter key will accept the new setting. Pressing the Reset key will ignore the new setting.

If an alarm condition occurs when the user is entering data, the data will be ignored, and the display will show the alarm screen. If a status condition occurs when data is being entered, the display will not change.

Once the user has finished entering data by pressing the Enter key, pressing the Reset key will allow the user to select other pages using the left and right arrow keys.

## ALARMS

All analog channels have alarms associated with them. There is also a coolant level alarm, an emergency stop alarm and eight user definable inputs that can be used to generate alarms. Alarms can be status messages, non-latching alarms, latching alarms or shutdown alarms. When a new alarm condition occurs, the alarm LED and the display back light will flash. Also, the alarm relay contacts will close (operating the audible alarm), and the display will show the alarm message. The user will be able to accept the alarm (turn off the audible alarm) from the keypad, and if the alarm condition has cleared, he or she also will be able to clear the alarm. Non-latching alarms will clear themselves if the alarm condition is no longer present. Latching alarms require the user to clear the alarm from the keypad even if the alarm condition is no longer present. Shutdown alarms are similar to latched alarms, but they also cause the generator to stop and will not allow it to start again until the key-switch has been turned to the OFF position to reset the alarm. Status messages are similar to non-latching alarms except that they do not activate the alarm relay or the alarm LED and are not recorded on the alarm log.

Alarms can be always active, immediately active when the generator is commanded to run, or active after the hold off timer has expired. This timer delays the operation of certain alarms until a programmable time after the engine has started. Some alarms allow the user to define the type of alarm and when it is active.

The following chart is a summary of the alarms and the programmable options:

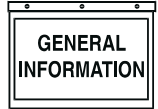

<b>Alarm Message</b>	<b>Alarm Active Options</b>	<b>Alarm Type Options</b>
Pre-Low Oil Pressure Warning	Hold Off	Non-Latch
Low Oil Pressure Shutdown Alarm	Hold Off	Shutdown
Pre-High Coolant Temp. Warning	Hold Off	Non-Latch
High Coolant Temp. Shutdown Alarm	Hold Off	Shutdown
Low Coolant Temp. Warning	Always	Non-Latch
Pre-High Oil Temp. Warning	Immediate, Hold Off, Disabled	Non-Latch
High Oil Temp. Shutdown Alarm	Immediate, Hold Off, Disabled	Shutdown
Low Battery Voltage Warning*	Always	Non-Latch
Overspeed Alarm	Immediate	Shutdown
Underspeed	Hold Off	Non-Latch, Latch, or Shutdown Status
Overcrank Alarm	Immediate	Shutdown
Over Voltage	Hold Off	Non-Latch, Latch, or Shutdown Status
Under Voltage	Hold Off	Non-Latch, Latch, or Shutdown Status
Over Frequency	Hold Off	Non-Latch, Latch, or Shutdown Status
Under Frequency	Hold Off	Non-Latch, Latch, or Shutdown Status
High Fuel Warning	Always, Disabled	Non-Latch
Low Fuel Warning	Always, Disabled	Non-Latch
Low Fuel Shutdown Alarm	Always, Disabled	Shutdown
User Analog Alarms**	All Options Available	All Options Available
Low Coolant Level Alarm	Hold Off	Shutdown
Emergency Stop	Always	Shutdown
RPM Sensor Failure Alarm	Always	Shutdown
Start Inhibit – Oil Pressure	Immediate	Shutdown
Oil Pressure Sensor Failure	Always	Shutdown
Oil Temp. Sensor Failure	Always, Disabled	Shutdown
Coolant Temp. Sensor Failure	Always	Shutdown
User Digital Input Alarms***	All Options Available	All Options Available
High Battery Voltage Warning	Always	Non-Latch

\* Battery voltage must be below alarm limit for 5 minutes to trigger alarm.  
 \*\* Each user analog input channel has a high and low alarm.  
 \*\*\* Each user digital input can be programmed to trigger an alarm on high or low level.

## ALARM PROCESSING

### ◆ INPUT ALARM FUNCTIONS

The E option panel will monitor the status of the analog and digital inputs, and generate alarm messages as required. Digital alarms and user-defined analog alarms are fully programmable. The user is able to select the type of alarm, the state of the input that will trigger the alarm, and the alarm message when it is active. The configurations are defined as follows:

#### ✦ Alarm Active

The user is able to select when the alarm is active. The options will be as follows:

- **Disabled:** If this option is selected, the alarm is disabled and has no effect.
- **Always:** With this option selected, the alarm is active regardless of the state of the generator.
- **Immediate:** In this mode, the alarm is not active when the generator is stationary. It becomes active as soon as the generator starts to crank and remains active until the generator stops.
- **Hold Off:** This option waits until a preset time after the generator is running before becoming active. The hold off time can be set by the user. Note that the hold off time is common to all alarms.

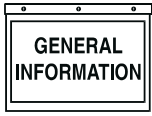

## ◆ ALARM TYPE

---

### ✧ Status

This type of alarm will display a message on the screen. The message will not be logged. This is the lowest priority of alarm types.

### ✧ Warning – Non-Latched

This type of warning will activate the audible alarm, and flash the alarm LED and display back light. The associated message will be displayed on the screen. When the user accepts the warning (by pressing the Enter key), the back light will stop flashing, and the alarm LED will be on continuously. The message will be displayed on the alarm screen, but the user will be able to scroll through other screens. The LED and message will clear when the warning condition clears. This type of warning is logged.

### ✧ Alarm – Latched

This type of alarm will act similarly to the non-latched warning, except that the alarm does not clear when the alarm condition clears. When the alarm condition occurs, the audible alarm sounds, the LED and back light flash as before, and the user must accept the alarm to stop them. The alarm will continue to be displayed on the screen even after the alarm condition has cleared. The user must either press the Reset key or turn the key-switch to the OFF position to clear the alarm after the alarm condition has cleared. This type of alarm is logged.

### ✧ Shutdown

This type of alarm will act similar to the latched alarm, but it also will stop the engine when the alarm condition occurs. It can be reset only by turning the key-switch to the OFF position. All shutdown alarms are latching, and this type of alarm is logged.

### ✧ Alarm Status

This is the value at which the alarm is active. For analog alarms, it is a number corresponding to the alarm limit. Digital alarms are either “normally open” or “normally closed,” and an alarm is generated when the input is not in the normal state.

### ✧ Alarm Message

Each alarm will have a message associated with it. The analog alarm messages will be preset, and the digital alarm messages and user-defined analog messages will be entered via the keypad or the serial link.

## ◆ OTHER ALARMS

---

### ✧ Overcrank

This alarm is unlike other alarms as it is not associated with an analog or digital signal. The user is able to define the number of crank attempts, the length of each crank attempt and the rest time between cranks. After the last attempt has been made, an overcrank alarm will be generated. The user will then be unable to disable this alarm or alter the alarm message.

### ✧ Coolant Level

This alarm is generated by the coolant level detector. This device senses whether coolant is present or not. It has no user-definable level setting and is a shutdown alarm that is active after the hold off time. There are no user-definable parameters for this alarm.

## PROGRAMMABLE PARAMETERS

The E option panel allows the user to configure various options to control the generator starting and stopping cycles, and the way that the alarms operate. Parameters are entered either from the control module or via the serial link. A description of the programmable parameters follows:

### ◆ PREHEAT ENABLED

---

This parameter determines how the preheat function works. The preheat can be fully disabled, enabled before starting only (for the duration of the preheat time), or before and during starting (for the duration of the preheat time and also while the starter is engaged). Note that if the user wishes to engage the preheat during starting but not to have a preheat before starting, it is possible to set the preheat time to zero.

### ◆ PREHEAT TIME

---

When a start command is received, some engines require preheating before the generator attempts to start. When the preheat function is enabled, this parameter allows the user to determine the time that the preheat contact closes before activating the starter solenoid.

### ◆ **START TIME**

Once a start command has been received and the preheat time has expired (if enabled), the starter solenoid will be engaged. This parameter allows the user to determine how long the starter solenoid is engaged before the start attempt is regarded as having failed. If the generator does not start within this time, the generator will wait for a preset time before attempting to start again. The user also can program the number of start attempts the generator tries.

### ◆ **PAUSE TIME**

If the generator does not start within the programmed start time, it will pause before trying to start again. This parameter determines the length of that pause.

### ◆ **START ATTEMPTS**

This parameter determines the number of times that the generator tries to start. If the generator has not started after this number of attempts, an alarm is generated.

### ◆ **STARTER DISENGAGE SPEED**

While the starter is engaged, the engine speed is monitored. Once it reaches this value, the starter motor is disengaged, and the engine is regarded as having started.

### ◆ **HOLD OFF TIME**

Once the engine has started, some alarm functions (such as low oil pressure and under speed) are not activated immediately since the engine must be given time to reach a stable condition. This parameter determines the time that elapses before the hold off alarms are activated.

### ◆ **COOL-DOWN TIME**

It is sometimes desirable to run the generator for a given time with no load before stopping to allow the engine to cool down. This parameter determines the length of time that the generator continues to run after a stop command is sent in AUTO mode. Note that if the key-switch is turned to the OFF position when the generator is running, it will stop immediately regardless of this setting. This value also should be set to zero if this function is controlled by the transfer switch.

### ◆ **LOAD ACCEPT VOLTAGE AND FREQUENCY**

Once the generator has started, the voltage and frequency will ramp up until they reach the values at which the generator can accept load. These parameters allow the user to set the values. The values should be set slightly lower than the nominal values to allow for a margin of error in the regulator and governor settings. Once the values have been reached, the warm-up timer is started.

### ◆ **WARM-UP TIME**

Some applications require that the generator is allowed to run for a given time before a load is applied. This parameter allows the user to set that time. Note that if this function is controlled elsewhere (e.g., within a transfer switch), this time should be set to zero. The generator is ready to accept load when this timer expires. This parameter can be assigned to an output relay.

### ◆ **FLYWHEEL TEETH**

This parameter holds the number of flywheel teeth. This value is used to determine the engine speed from the magnetic pickup signal.

### ◆ **USER-DEFINED OUTPUT FUNCTIONS**

There are three user-defined outputs, and the preheat output also can be used as a user-defined output if the preheat function is disabled. Each output can be programmed to signal that an alarm is active, to indicate one specific alarm or input condition, to indicate the status of the key-switch, or to indicate the current status of the generator.

**NOTE:**

**See the “Output Function Table” on Page 11 for more detail.**

### ◆ **ANALOG INPUT SCALING FACTORS**

The two user-defined analog inputs can be scaled so that the display uses meaningful values rather than the voltage level at the input. The user enters the value to be displayed when the input voltage is zero and when it is at the maximum value. (An analog input to the E panel is a voltage sourced input with a zero- to 10-volt range.) All alarm settings are based on this scaling, and the instrumentation display shows the input value based on this scaling too.

### ◆ **ANALOG INPUT MESSAGES**

This is a message up to 24 characters long that is displayed on the instrumentation display when the corresponding value is being shown.

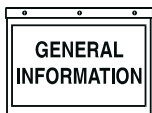

## ◆ ANALOG INPUT ALARM MESSAGES

There is a user-definable message for each alarm condition on each analog input. This message is shown on the alarm display when the alarm condition is active and is stored in the alarm log.

## ◆ ANALOG INPUT ALARM SETTINGS

Each analog input has two alarms associated with it. One is activated when the input value is higher than the high set-point, and the other is active when the input is lower than the low set-point. The user also can define when the alarm is active (or disable it) and the severity of the alarm (from simply displaying a status message to shutting down the generator – see “Alarm Processing” on Page 5).

## ◆ DIGITAL INPUT ALARM SETTINGS

Each digital input also can generate an alarm. The user can program the alarm message, the input state that generates the alarm, when the alarm is active, and the alarm type. A digital input to the E panel is NOT a voltage sourced input, but a dry contact closure to ground. Voltage never should be sourced to a digital input. The signal options to a digital input are as follows:

- **High:** This signal is an open circuit.
- **Low:** This signal is a contact closure to ground.

## ◆ OIL PRESSURE ALARMS

The oil pressure input has two associated alarm functions. The pre-low oil pressure warning is a non-latched, hold off alarm with a user-definable set-point. The low oil pressure shutdown is a shutdown, hold off alarm with a user-definable set-point. The shutdown alarm set-point should be the lowest of the two settings so that the user will have some warning of a low oil condition before the generator is shut down.

## ◆ OIL TEMPERATURE ALARMS

The oil temperature has a non-latched warning and a shutdown alarm associated with it. The set-points are programmable, and the alarms can be immediate, hold off or disabled.

## ◆ COOLANT TEMPERATURE ALARMS

The coolant temperature input has three associated alarms. The pre-high coolant temperature alarm is a non-latched, hold-off alarm. The high coolant temperature alarm is a shutdown, hold-off alarm. The low coolant temperature warning is a non-latched, always active alarm. Set-points for each alarm are programmable.

## ◆ BATTERY VOLTAGE ALARMS

The low battery voltage warning set-point is programmable. The warning will be activated if the battery voltage is below this value for more than five minutes. This is a non-latched, always active alarm. Note that the “Power” LED on the front panel is extinguished immediately if the battery voltage is less than this value. The high battery voltage alarm set-point is also programmable. The warning is active immediately when the battery voltage is higher than this value.

## ◆ ENGINE SPEED ALARMS

The user can program the overspeed and the underspeed alarm. The overspeed alarm is an immediate shutdown alarm. Underspeed is a hold off alarm that can either be non-latched, latched or shutdown.

## ◆ GENERATOR VOLTAGE ALARMS

An alarm can be generated for high voltage and low voltage. The set-points are user-definable, and the alarms can be either non-latching, latching or shutdown.

## ◆ GENERATOR FREQUENCY ALARMS

An alarm can be generated for high frequency and low frequency. The set-points are user-definable, and the alarms can be either non-latching, latching or shutdown.

## ◆ FUEL LEVEL ALARMS

Alarms can be generated by an optional fuel level sensor. The high fuel level warning is non-latching. There is also a low fuel level warning that is non-latching and a low fuel shutdown alarm. Each of these alarms has a set-point and can be always active or disabled.

## ◆ SERIAL COMMUNICATIONS

### ✧ Serial Communication Via Modem

The control panel has the ability to communicate to a PC via an RS232 serial port. The PC software will be able to interrogate the module, and the user also will be able to program the parameters on the PC and download them to the module. The user will be able to start and stop the generator if it is in AUTO mode.

The module does not have a built-in modem. However, software will include the ability to interface with an external modem. The user can initialize the modem from the panel.

### ◆ Remote Annunciator Panel

The serial connections can be configured to allow the control panel to connect to a remote annunciator/remote relay panel, which is configured as RS485, to meet NFPA 110. Only one communication port is available for either a modem or remote annunciator.

### ◆ Altering the Serial Communications Setup

The following instructions are necessary to alter the serial communications setup on your unit:

The E option control panel is capable of being used with either a modem or a remote annunciator/remote relay panel, depending on the configuration of the serial connections. The unit comes set up for connection to a modem (RS232). In order to use the control panel with a remote annunciator/remote relay panel (RS485), adhere to Figure 2 and the instructions that follow.

**Figure 2 – E Panel Serial Communications Setup Modification**

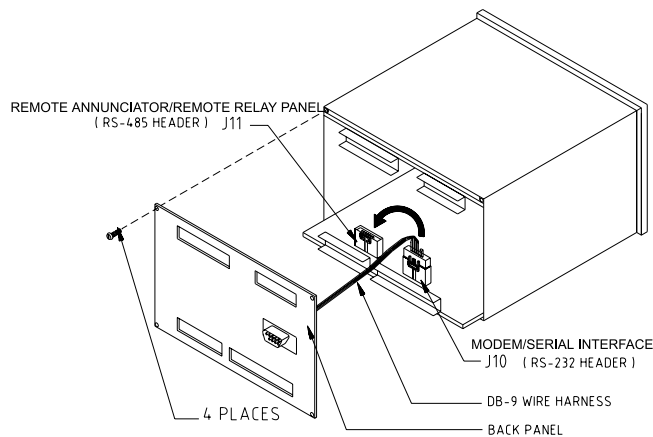

1. Unplug all four wire harnesses from the back of the E panel control module.
2. Remove the four phillips head screws retaining the rear cover of the control module.
3. Open the back of the control module.
4. Locate the DB-9 wire harness that runs from the DB-9 connector on the back panel to the black header on the lower circuit board inside the control module.
5. Carefully remove the black connector from the header by pressing the locking tab and lifting up.
6. Insert the black connector into the RS485 header (J11). Make sure that the connector is fully inserted and that the locking tab snaps into place.
7. Replace the back panel and the four screws.

### NOTE:

**The previous diagram and instructions apply only to those units manufactured before January 2000. Units manufactured after January 2000 will incorporate a selector switch on the back of the control module. This switch will allow selection of either RS232 or RS485 without opening the module.**

### ◆ USER PASSWORD

The user can set the password. This is a six-digit number and is initially set to 000000.

## ADDITIONAL PANEL COMPONENTS

In addition to the control module, the E option panel contains the following components (see Figure 3, Page 10):

### ◆ AC VOLTMETER

This meter indicates the generator AC output voltage. (Also see “Line-phase Selector Switch” and “Voltage Adjust Potentiometer” in this section.) To determine the nominal rated AC voltage of your unit, refer to your unit’s data plate.

### NOTE:

**Some generators are reconnectable to a variety of voltages. Some units may be equipped with a rotary “Voltage Selector Switch.” Be sure to read the “Generator AC Lead Connections” section in your Owner’s Manual.**

### ◆ AC AMMETER

This meter indicates the current draw of connected electrical loads, in amps. Also see “Line-phase Selector Switch.” For continuous operation, never exceed the rated maximum continuous current capacity of your generator.

### ◆ FREQUENCY METER

This meter indicates the generator’s AC output frequency in “Hertz” (cycles per second).

### ◆ LINE-PHASE SELECTOR SWITCH

This four-position switch permits you to select either line-to-line or line-to-neutral readings on the panel voltmeter and ammeter. Switch positions are as follows:

Switch	Single-phase Units	Three-phase units
1	Line E1 to Neutral	Line E1 to E2
2	Line E3 to Neutral	Line E2 to E3
3	Line E1 to E3	Line E3 to E1

Figure 3 – E Option Panel Components

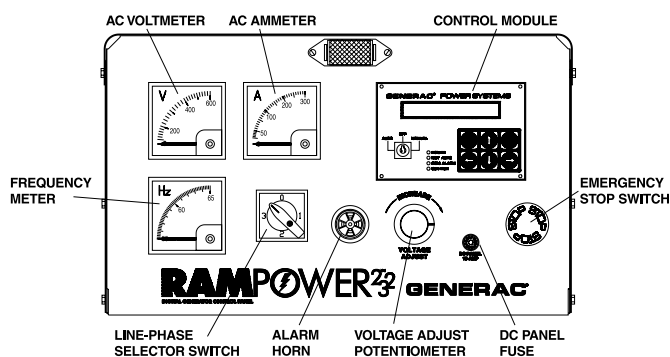

- The battery supply wires (#13 and #0) to the panel control module are open circuit (disconnected).
- The “Power” connector (CON4) is disconnected from the rear of the control module.
- The generator start battery connections have been reversed. Reversal of the battery connections **WILL** blow the internal fuse and is the most likely reason for its failure.

Before removing or disconnecting the E panel control module, check that none of the above conditions (a-e) exist.

**If you are satisfied that the problem lies with the control module ...**

- Disconnect the generator start battery.
- Unplug all four wire harnesses from the back of the control module.
- Loosen, then detach, the two retaining clips securing the control module and remove the module.
- Using a multimeter (e.g., Fluke 87) set to the diode range, measure between pins 1 (BAT+) and 2 (BAT-) of connector CON4 on the module.
  - With the **positive** meter lead connected to **pin 2** and the **negative** lead to **pin 1**, the meter should read between 0.4 and 0.6 volts, which indicates that the internal fuse is OK.
  - Reversing the meter leads would give a slowly increasing voltage reading on the meter, which also indicates a good fuse.
  - An open circuit fuse will give an open circuit meter reading (.OL on Fluke 87).

**If the meter reads open circuit ...**

- Remove the four phillips head screws retaining the rear cover of the control module.
- Open the back of the control module.
- Locate the internal printed-circuit board mounted fuse, which is behind and to the left of CON4.
- Remove the white plastic cover from the fuse holder and remove the fuse.
- If the fuse has blown, replace the fuse (part # A5705), reassemble the control module, and reinstall the control module and its connections.
- Reconnect the generator start battery and check if the control module now functions.

If the fuse blows again, or was not blown when the module was opened, or the module still does not function, the E panel control module must be replaced.

**VOLTAGE ADJUST POTENTIOMETER**

This potentiometer permits the operator to “fine adjust” the generator’s AC output voltage. Adjustment range is plus or minus 5 percent. Turn the knob clockwise to increase voltage, counterclockwise to decrease voltage.

**ALARM HORN**

This horn sounds an audible warning when an alarm condition exists. See the “Alarms” section for further information.

**DC PANEL FUSE**

This 15-amp fuse protects the panel components. This fuse is not to be confused with the control module internal fuse discussed in “Checking/Replacing the E Panel Control Module Internal Fuse”

**EMERGENCY STOP SWITCH**

When pressed, this switch will automatically shut down the entire generator set. The operator must pull the switch out to its original position to reset it and allow for generator operation.

**CHECKING/REPLACING THE E PANEL CONTROL MODULE INTERNAL FUSE**

Typically, the main indication of fuse failure is the absence of any illuminated front panel LEDs (even with the key in the OFF position, the “Power” LED will be illuminated) and no text visible on the module display. It should be noted however, that these conditions can exist if either ...

- The generator start battery is dead (less than 5 volts) or disconnected.
- The main panel fuse (15 amp) is blown.





## E CONTROL PANEL DEFINITIONS

Please refer to the following list for an explanation of terms used in various charts throughout the manual:

- **ALWAYS:** With this option selected, the alarm is active regardless of the state of the generator.
- **ANALOG INPUT:** An analog input to the E control panel is a voltage sourced input with a 0-volt to 10-volt range.
- **DIGITAL INPUT:** A digital input to the E control panel is NOT a voltage sourced input, but a dry contact closure to ground. Voltage should never be sourced to a digital input.
- **DISABLED:** If this option is selected, the alarm is disabled and has no effect.
- **HIGH:** A high signal to a digital input is open circuit.
- **HOLD OFF:** This option waits until a preset time after the generator is running before becoming active. The hold off time can be set by the user. Note that the hold off time is common to all alarms.
- **IMMEDIATE:** In this mode, the alarm is not active when the generator is stationary. It becomes active as soon as the generator starts to crank and remains active until the generator stops.
- **LATCHED:** When the alarm condition occurs, the audible alarm sounds, the LED and back light flash as before, and the user must accept the alarm to stop them. The alarm will continue to be displayed on the screen even after the alarm condition has cleared. The user must either press the Reset key or turn the key-switch to the OFF position to clear the alarm after the alarm condition has cleared. This type of alarm is logged.
- **LOW:** A low signal to a digital input is a contact closure to ground.
- **NON-LATCHED:** This type of warning will activate the audible alarm, and flash the alarm LED and display back light. The associated message will be displayed on the screen. When the user accepts the warning (by pressing the Enter key), the back light will stop flashing, and the alarm LED will be on continuously. The message will be displayed on the alarm screen, but the user will be able to scroll through other screens. The LED and message will clear when the warning condition clears. This type of warning is logged.
- **SHUTDOWN:** This type of alarm will act similar to the latched alarm, but it also will stop the engine when the alarm condition occurs. It can be reset only by turning the key-switch to the OFF position. All shutdown alarms are latching, and this type of alarm is logged.
- **STATUS:** This type of alarm will display a message on the screen. The message will not be logged. This is the lowest priority of alarm types.
- **USER INPUT:** Any of the eight digital or two analog inputs reserved for customer options.

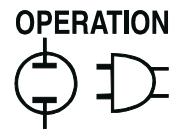

## OUTPUT FUNCTION TABLE

Output Function ID	Function Name	Description
00	Output not used	
01	Common Alarm	Active for all latched, non-latched and shutdown alarms
02	Pre-Low Oil Pressure	Active after hold off time
03	Low Oil Pressure	Active after hold off time
04	Pre-High Water Temperature	Active after hold off time
05	High Water Temperature	Active after hold off time
06	Low Water Temperature	
07	Pre-High Oil Temperature	
08	High Oil Temperature	
09	Low Battery Volts	Must be below set value for five minutes
10	High Battery Volts	
11	Overspeed	
12	Underspeed	Active after hold off time
13	AC Voltage High	Active after hold off time
14	AC Voltage Low	Active after hold off time
15	High Frequency	Active after hold off time
16	Low Frequency	Active after hold off time
17	High Fuel	
18	Low Fuel	Below the warning set-point
19	Critical Low Fuel	Below the shutdown set-point
20	Failed to Start	Overcrank
21	Coolant Level	
22	RPM Sensor Loss	
23	Oil Pressure Start Inhibit	Oil pressure was present at start request
24	Emergency Stop	
25	Oil Pressure Sensor Failure	Sensor is either open or short circuit
26	Oil Temperature Sensor Failure	Sensor is either open or short circuit
27	Coolant Temperature Sensor Failure	Sensor is either open or short circuit
28	User Analog Channel 1 High	Input at user analog channel 1 is above programmed high set-point
29	User Analog Channel 1 Low	Input at user analog channel 1 is below programmed low set-point
30	User Analog Channel 2 High	Input at user analog channel 2 is above programmed high set-point
31	User Analog Channel 2 Low	Input at user analog channel 2 is below programmed low set-point
32	User Digital Alarm 1	User programmable digital input 1 is active
33	User Digital Alarm 2	User programmable digital input 2 is active
34	User Digital Alarm 3	User programmable digital input 3 is active
35	User Digital Alarm 4	User programmable digital input 4 is active
36	User Digital Alarm 5	User programmable digital input 5 is active
37	User Digital Alarm 6	User programmable digital input 6 is active
38	User Digital Alarm 7	User programmable digital input 7 is active
39	User Digital Alarm 8	User programmable digital input 8 is active
40	Generator in Auto	
41	Generator in Manual	
42	Generator Off	
43	Generator Stopped	
44	Generator Alarm Shutdown	
45	Generator Ready to Start	
46	Generator Running	
47	Generator Ready to Accept Load	Generator has reached load accept voltage and frequency set-points, and the warm-up timer has expired
48	Generator Running, Alarm Active	

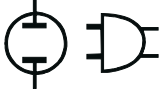

## E PANEL MASTER CONTROL BOX CONFIGURATION SETTINGS

### STANDARD ALARM CONFIGURATION MENU

Parameter	Value	Units	Active	Type
Pre-Low Oil Pressure Warning	0 to 100	PSI	Hold Off	Non-latch
Critical Low Oil Pressure Alarm	0 to 100	PSI	Hold Off	Shutdown
Low Coolant Temp Warning	0 to 245	Deg. F	Always	Non-latch
Pre-High Coolant Temp Warning	0 to 245	Deg. F	Hold Off	Non-latch
High Coolant Temp Alarm	0 to 245	Deg. F	Hold Off	Shutdown
Pre-High Oil Temp Warning	0 to 245	Deg. F	(A1)	Non-latch
High oil Temp Alarm	0 to 245	Deg. F	(A1)	Shutdown
Low Battery Level Warning	4 to 30	V	Always	Non-latch
High Battery Level Warning	4 to 30	V	Always	Non-latch
Engine Over Speed Alarm	0 to 4500	RPM	Immediate	Shutdown
Engine Under Speed	0 to 4500	RPM	Hold Off	(T1)
Generator Over Voltage	0 to 800	V	Hold Off	(T1)
Generator Under Voltage	0 to 800	V	Hold Off	(T1)
Generator Over Frequency	0 to 100	Hz	Hold Off	(T1)
Generator Under Frequency	0 to 100	Hz	Hold Off	(T1)
High Fuel Level Warning	0 to 100	%	(A2)	Non-latch
Low Fuel Level Warning	0 to 100	%	(A2)	Non-latch
Critical Low Fuel Level Alarm	0 to 100	%	(A2)	Shutdown

**Available Options:**

- A1 = Disable, Holdoff, Immediate
- A2 = Disable, Always
- T1 = Shutdown, Latched, Non-latched, Status

### ENGINE CONFIGURATION MENU

Parameter	Value	Unit	
Flywheel Teeth	50 to 200	Number	Preheat Option (P1)
Load Accept Frequency	0 to 90	Hz	Preheat Alternative (F1)
Load Accept Voltage	0 to 800	V	Output 1 (F1)
Starter Disengage Speed	0 to 4000	RPM	Output 2 (F1)
Number of Start Attempts	0 to 10	Number	Output 3 (F1)
Generator Cool Down Time	0 to 600	min	
Generator Warm Up Time	0 to 600	sec	
Alarm Hold Off Time	0 to 15	sec	
Start Attemp Pause Time	5 to 600	sec	
Start Timer	0 to 15	sec	
Preheat Timer	0 to 30	sec	

**Available Options:**

- P1 = No preheat, Preheat Before Start, Preheat Before and durring
- F1 = See output function table for available options

**USER CONFIGURATION MENU**

	Analog Channel1	Analog Channel2
Channel Title		
Upper Scaling Factor		
Lower Scaling Factor		

Message	Setpoint	Active	Type
Analog1 High		(A1)	(T1)
Analog1 Low		(A1)	(T1)
Analog2 High		(A1)	(T1)
Analog2 Low		(A1)	(T1)
User input 1	*1 Battery Charge Fail (S1)	(A1)	(T1)
User input 2	*1 Generator Power (S1)	(A1)	(T1)
User input 3	*1 Line Power (S1)	(A1)	(T1)
User input 4	*2 Back-up low oil pressure (S1)	(A1)	(T1)
User input 5	*2 Back-up high engine temp (S1)	(A1)	(T1)
User input 6	*2 Oil filter blocked (S1)	(A1)	(T1)
User input 7	*2 MLCB (S1)	(A1)	(T1)
User input 8	*2 Ruptured Tank (S1)	(A1)	(T1)

Messages can be a maximum of 24 characters including spaces.

**Available Options:**  
 S1 = Low, High  
 A1 = Disabled, Hold Off, Immediate, Always  
 T1 = Shutdown, Latched, Non-Latch, Status

- \*1 Assigned if used with 20 light Remote Annunciator or Remote Relay Panel. Otherwise available for any customer options.
- \*2 Factory wired if unit is equipped with these options. Otherwise these inputs are available for any customer requirements.



# Appendix 2 – Operation E Option Control Panels

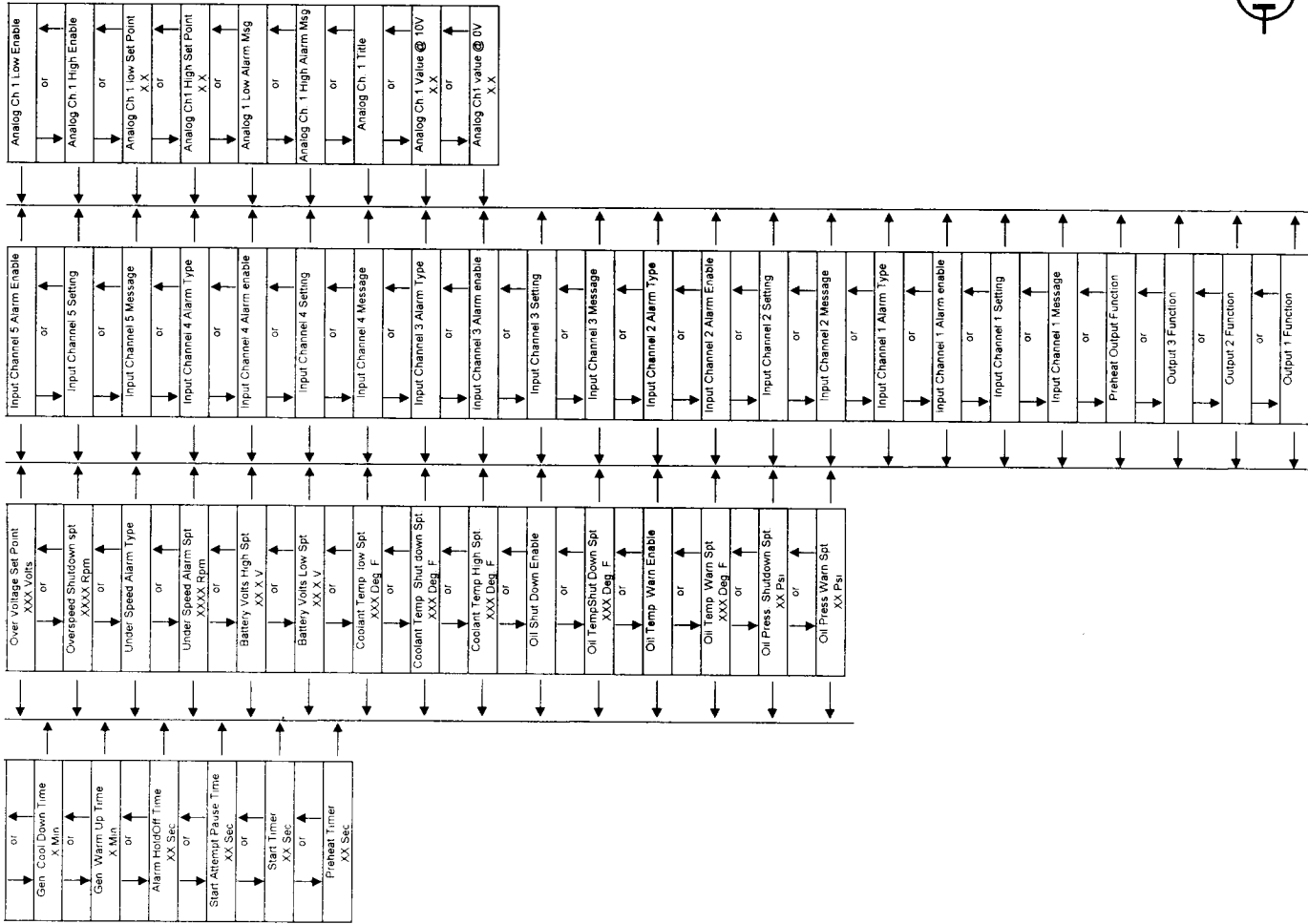
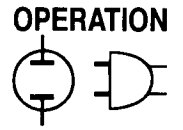



## Appendix 3 – Electrical Data

### E Option Control Panels Schematic Diagram (Units Less Than 400 kW) – Drawing No. A5501-

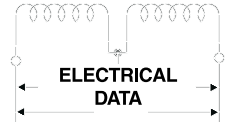

CODE	QTY	PART NO.	DESCRIPTION
AA	1	61286	AUDIBLE ALARM
AM	1	VARIOUS	AMMETER
AVR	1	67680	AUTOMATIC VOLTAGE REGULATOR
CB1	1	VARIOUS	AVR CIRCUIT BREAKER
D1	1	49939	FIELD BOOST DIODE
D2	1	25192	CHARGE ALT EXCITER DIODE
ES	1	98426A	EMERGENCY STOP BUTTON
ES1-3	3	98426C	NORMALLY CLOSED CONTACTS
HZ	1	PART NO.	FREQUENCY METER
L1	1	70202	PANEL LAMP
MC1	1	A4087	E-PANEL CONTROLLER ASSEMBLY
R1	1	VARIOUS	FIELD BOOST RESISTOR
R2	1	44213	CHARGE ALT EXCITER RESISTOR
SW1	1	61945	VOLT/AMMETER SWITCH
VM	1	VARIOUS	VOLTMETER
VR1	1	71361	VOLTS TRIM POTENTIOMETER

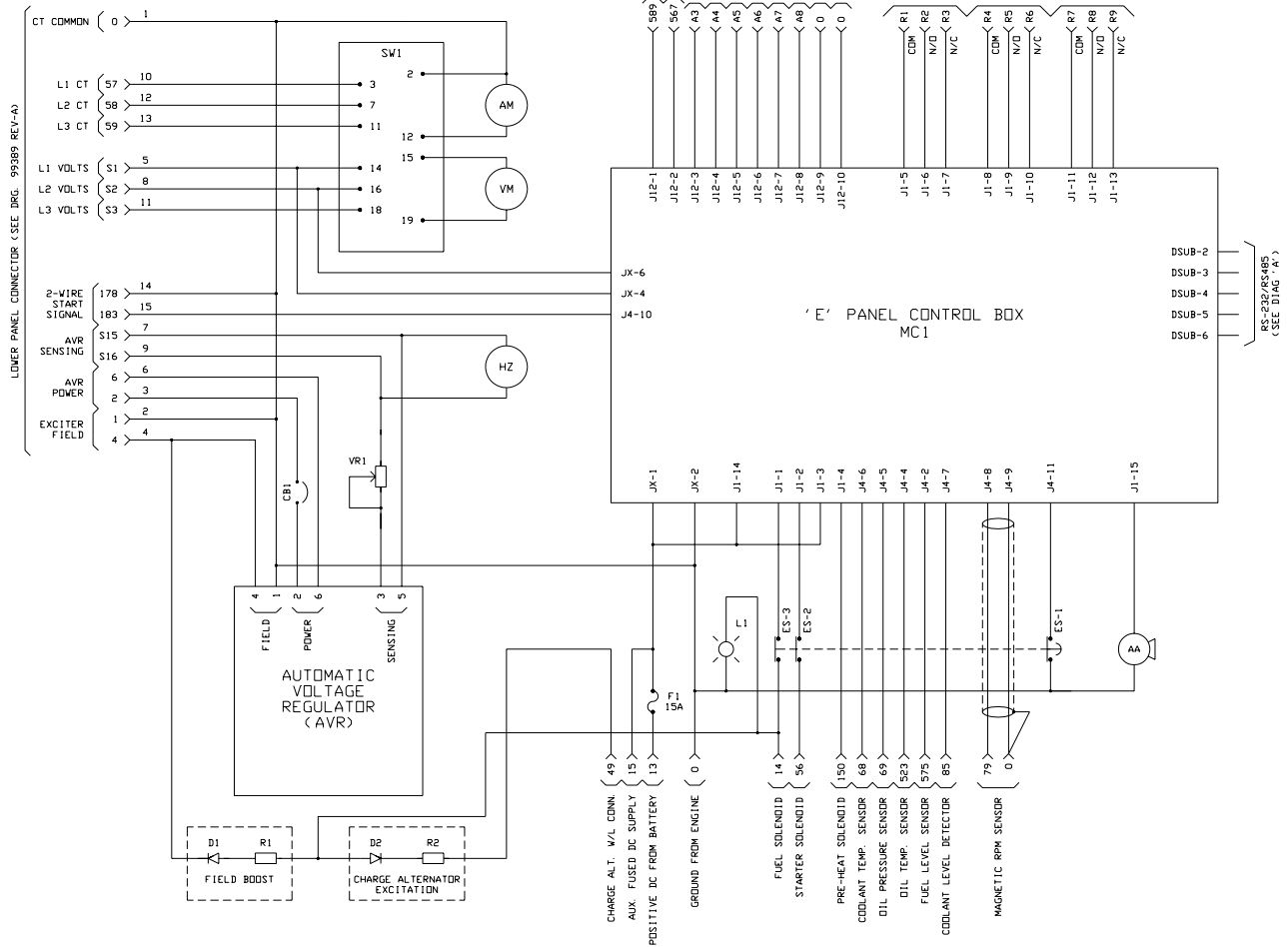

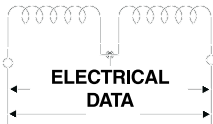

# Appendix 3 – Electrical Data

## E Option Control Panels

### Wiring Diagram (Units 400 kW and Larger) – Drawing No. C1376-A

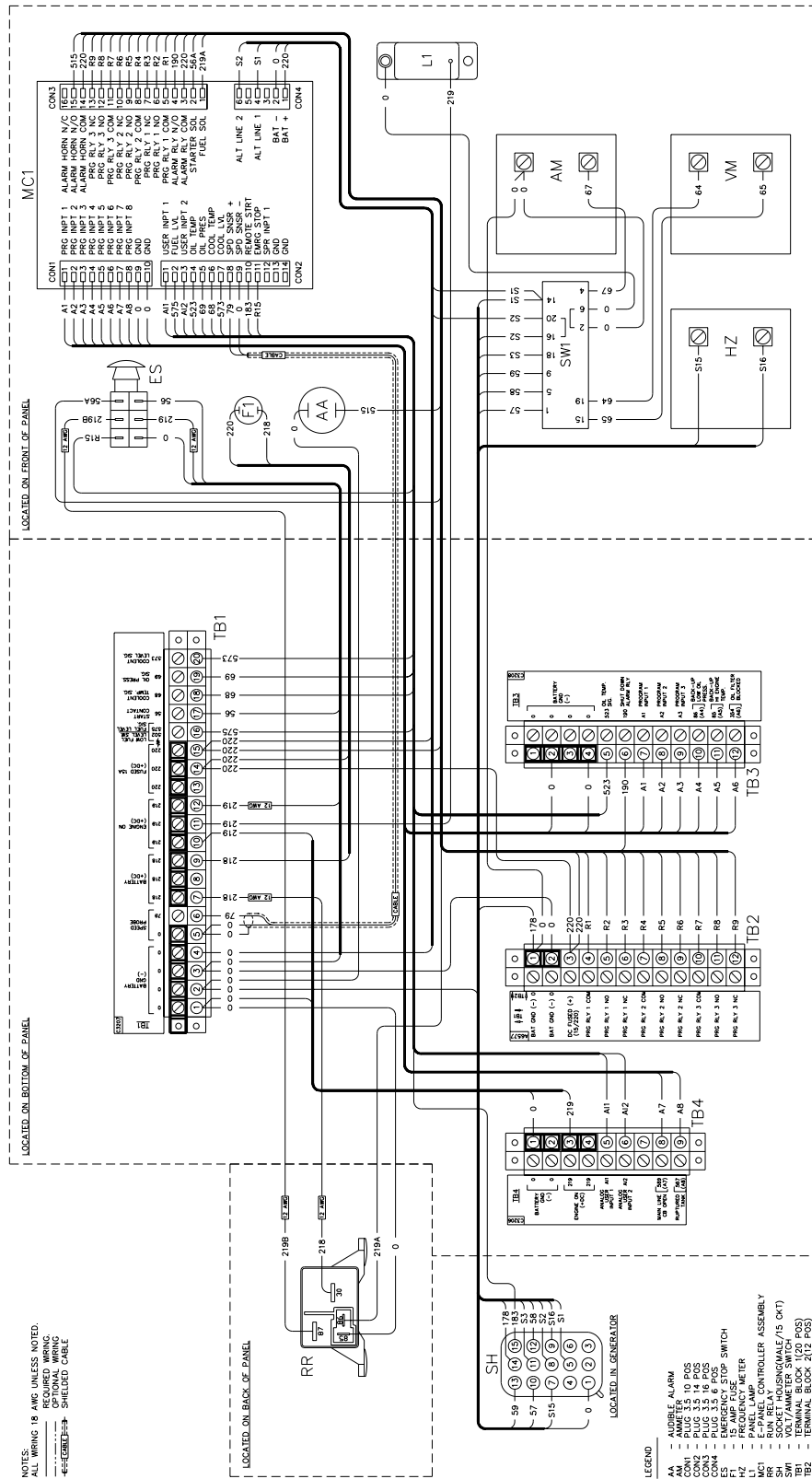

NOTES:  
 ALL WIRING 18 AWG UNLESS NOTED.  
 REQUIRED WIRING  
 SHIELDED CABLE

LEGEND  
 AA - AMMETER 10 POS  
 AM - AMMETER 10 POS  
 CON1 - PLUG 3, 5, 14 POS  
 CON2 - PLUG 3, 5, 14 POS  
 CON3 - PLUG 3, 5, 6 POS  
 CON4 - PLUG 3, 5, 6 POS  
 ES - EMERGENCY STOP SWITCH  
 HZ - FREQUENCY METER  
 L1 - PANEL LAMP  
 MC1 - CONTROL PANEL ASSEMBLY  
 RR - RUN RELAY  
 SW1 - SWITCH  
 TB1 - TERMINAL BLOCK (120 POS)  
 TB2 - TERMINAL BLOCK (120 POS)  
 TB3 - TERMINAL BLOCK (120 POS)  
 TB4 - TERMINAL BLOCK (4/8 POS)  
 VM - VOLTMETER

## Appendix 3 – Electrical Data

### E Option Control Panels Schematic Diagram (Units 400 kW and Larger) – Drawing No. C1375-A

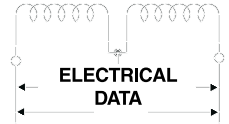

CODE	QTY	PART NO.	DESCRIPTION
AA	1	61286	AUDIBLE ALARM
AM	1	VARIOUS	AMMETER
D3	2	94261E	SURGE SUPPRESSING DIODE
ES	1	98426A	EMERGENCY STOP BUTTON
ES1-3	3	98426C	NORMALLY CLOSED CONTACTS
F1	1	32300	PANEL FUSE (15A)
HZ	1	VARIOUS	FREQUENCY METER
L1	1	70202	PANEL LAMP
MC1	1	A4087	E-PANEL CONTROLLER ASSEMBLY
R2	1	80294I	PULL UP RESISTOR (SEE NOTE)
RR	1	86035	RUN RELAY (70A)
SH	1	55089	SOCKET HOUSING
SW1	1	61945	VOLT/AMMETER SWITCH
VM	1	VARIOUS	VOLTMETER

**NOTES:**

----- PULL UP RESISTOR INSTALLED ONLY WHEN  
LOW FUEL LEVEL SWITCH IS USED.

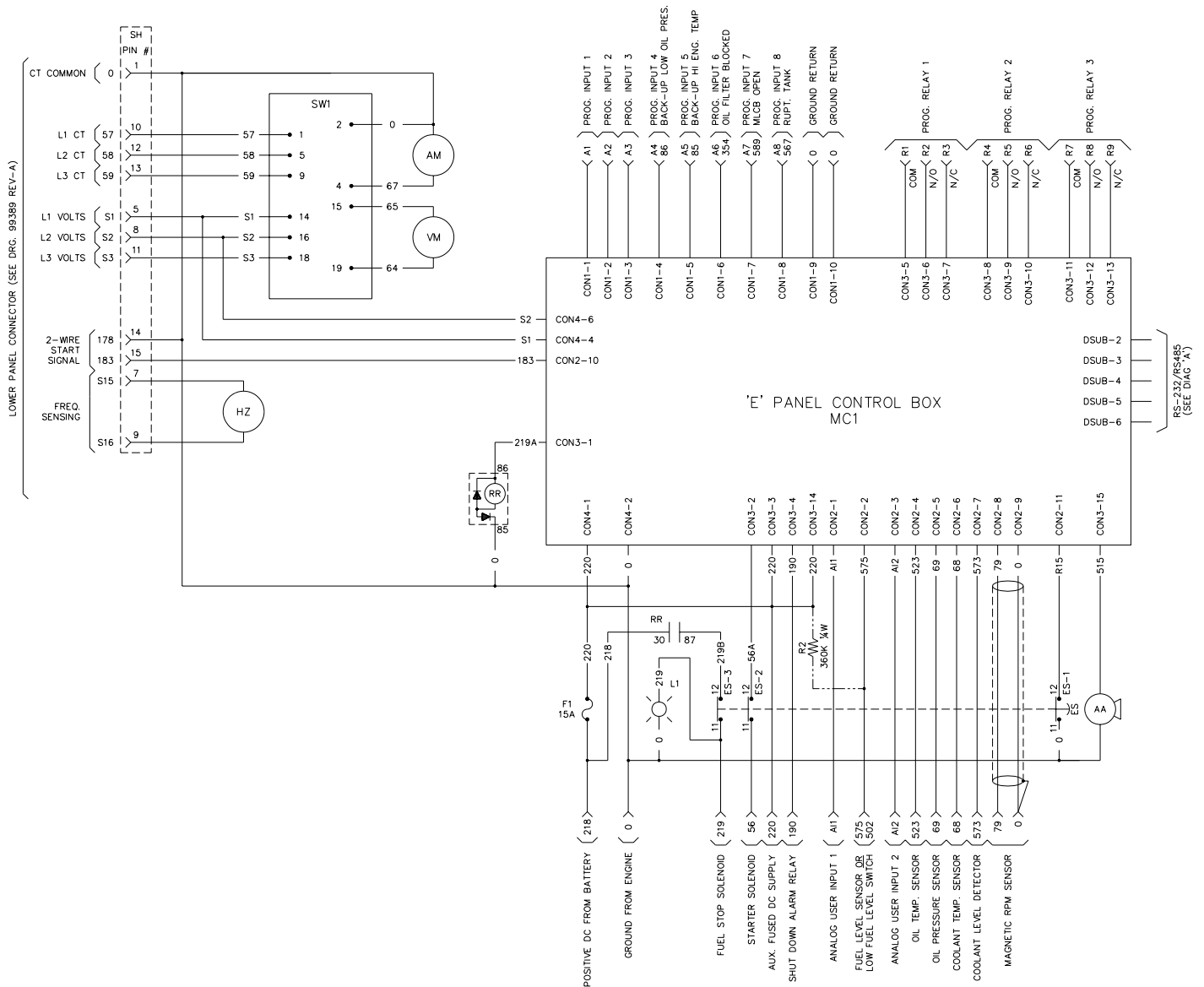



## Appendix 4 – Exploded Views and Parts Lists

### E Option Control Panels

### Control Panel (Units Less Than 400 kW) – Drawing No. A6325-H

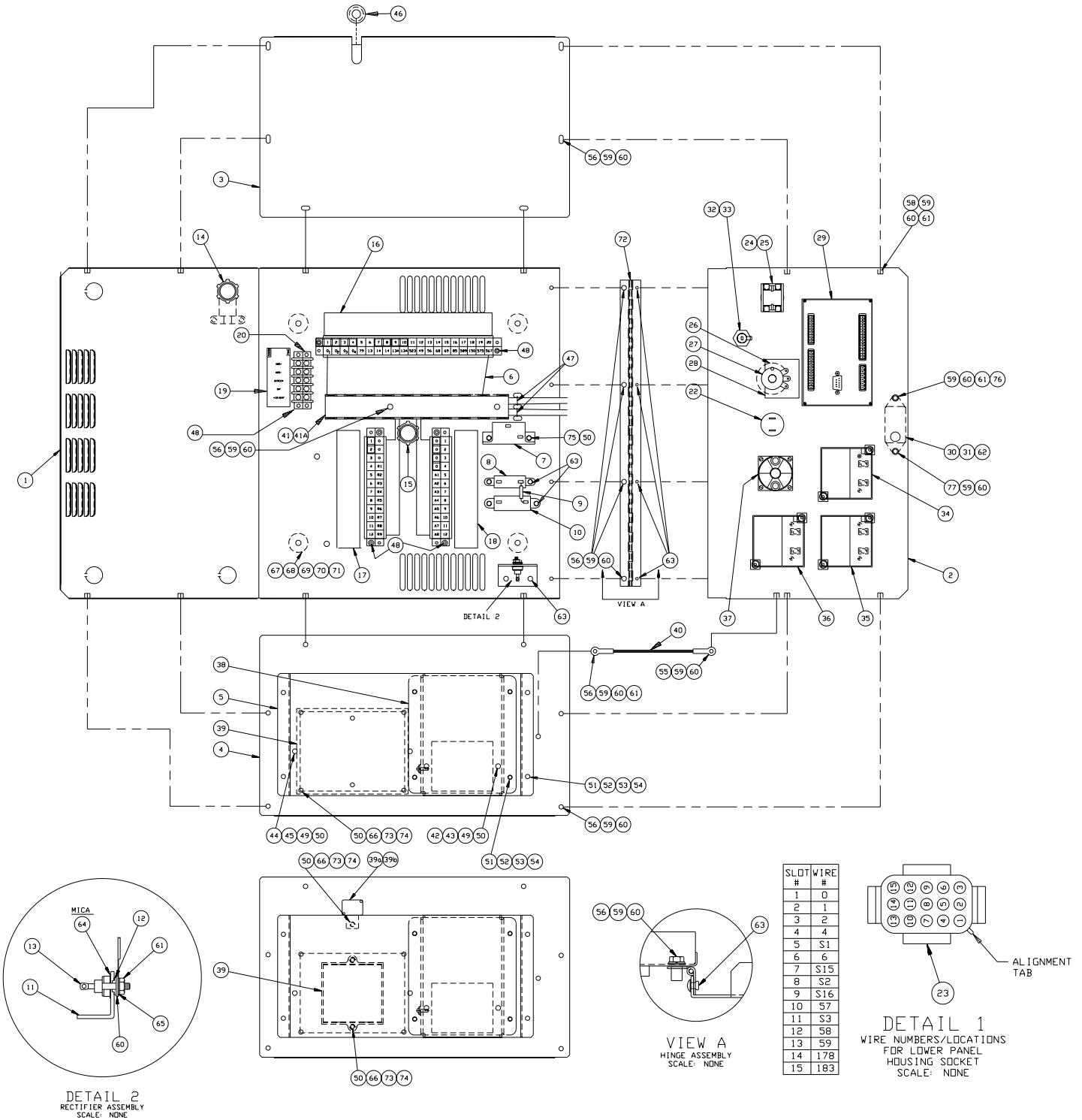
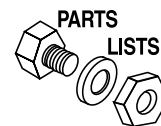

TABLE A – FIELD BOOST RESISTOR DATA	
All directly excited machines up to 100 kW with 12 or 24V DC systems	5 Ohm 25W P/N: 48352
All brushless machines up to 100 kW with 12V DC systems	25 Ohm 25W P/N: 57405
All brushless machines up to 100 kW with 24V DC systems	50 Ohm 25W P/N: 83364
All brushless machines up to 100 kW with 12 or 24V DC systems	75 Ohm 25W P/N: 86266

## Appendix 4 – Exploded Views and Parts Lists



### E Option Control Panels Control Panel (Units Less Than 400 kW) – Drawing No. A6325-H

ITEM	PART NO.	QTY.	DESCRIPTION	ITEM	PART NO.	QTY.	DESCRIPTION
1	A6320	1	CONTROL PANEL BOTTOM	39b	98942A	1	COVER, CONNECTOR HOUSING
2	A6324	1	CONTROL PANEL FRONT	40	A2275	1	FRONT PANEL STAY
3	A6322	1	CONTROL PANEL RIGHT SIDE	41	91472	9.5"	WIRE DUCT 1" X 1.5"
4	A6321	1	CONTROL PANEL LEFT SIDE	41A	91472A	9.5"	WIRE DUCT COVER 1"
5	A6323	1	CHASSIS AVR/E GOV.	42	A1441B	1	COVER PLATE, AVR
6	A6326	1	HARNESS E PNL. MAIN	43	A3393	1	DECAL, AVR COVER
7	See Table B	1	CIRCUIT BREAKER	44	A1441C	1	COVER PLATE, E-GOV
8	44213	1	RESISTOR 10 OHM 12W	45	A3394	1	DECAL, E-GOV COVER
9	25192	1	DIODE 600V 2A	46	30809	1	GROMMET 1/8-11/16
10	See Table A	1	RESISTOR 2	47	28739	2	TIE WRAP 4"
11	55444	1	HEAT SINK	48	A1661	8	POP RIVET
12	30468	1	STEP WASHER - NYLON	49	36901	3	#6-32 X 3/8" PPHMS
13	49939	1	RECTIFIER	50	22155	9	#6/M3 LOCK WASHER
14	39271	1	90° CONNECTOR 3/4"	51	36918	8	#8-32 X 1/2" PPHMS
15	34616	1	STRAIGHT CONNECTOR 3/4"	52	22264	8	#8/M4 LOCK WASHER
16	A3392-C	1	DECAL, TERMINAL STRIP	53	38150	8	#8/M4 FLAT WASHER
17	A6576	1	DECAL, TERMINAL STRIP TB2	54	22471	8	#8-32 HEX NUT
18	A6577	1	DECAL, TERMINAL STRIP TB3	55	33120	1	#10-32 X 3/8" HHMS
19	C2688	1	DECAL, TERMINAL STRIP TB4	56	33121	10	#10-32 X 1/2" HHMS
20	48850	1	TERMINAL BLOCK, 5 POS TB4	58	33147	1	#10-32 X 1" HHMS
22	61286	1	AUDIBLE ALARM	59	22152	17	#10/M5 LOCK WASHER
23	55089	1	HOUSING SOCKET 15 - CKT	60	23897	17	#10/M5 FLAT WASHER
24	98426A	1	EMERGENCY STOP SWITCH	61	22158	4	#10-32 HEX NUT
25	98426C	3	CONTACT, EMERGENCY STOP SWITCH	62	74130	1	LUG, PIN 4MM 22/18
26	71361	1	POTENTIOMETER	63	36261	10	POP RIVET
27	50123	1	KNOB	64	70370	2	MICA WASHER
28	55349	1	INSULATOR	65	23762	1	WASHER EXTERNAL SHAKE PROOF
29	A4087	1	MASTER CONTROL BOX	66	22985	2	#6/M3 FLAT WASHER
30	70202	1	PANEL LIGHT	67	40479	4	VIBRATION DAMPENNER
31	70082	1	LIGHT BLOCKER	68	22287	4	1/4-20 X 3/4" HHMS
32	32300	1	FUSE HOLDER	69	22097	4	1/4/M6 LOCK WASHER
33	22676	1	FUSE 15-A	70	22473	4	1/4/M6 FLAT WASHER
34	70045	1	AMMETER	71	47246	4	1/4 FLAT WASHER SPECIAL
35	70043	1	VOLT METER AC 0-300	72	A2273	1	HINGE
	70044	1	VOLT METER AC 0-600	73	36902	4	#6-32 X 1/2" PPHMS
36	70042	1	FREQUENCY METER 60 HZ	74	22188	4	#6-32 HEX NUT
	70042A	1	FREQUENCY METER 50 HZ	75	C2212	2	M4-0.7 X 16 TAPTITE
37	61945	1	VOLT/AMP SWITCH	76	24413	1	#10-32 X 1/2" TAPTITE
38	See Table C	1	AVR ASSEMBLY	77	C2720	1	#10-32 X 3/8" TAPTITE
39	See Table C	1	OPTIONAL ELECTRICAL GOVERNOR	*	A5705	1	INTERNAL MODULE FUSE, 5A (NOT SHOWN)
39a	98941A	1	HOUSING, CONNECTOR				

**TABLE B – AVR POWER (DPE) CIRCUIT BREAKER DATA**

All directly excited machines 19 to 45 kW	7A P/N: 48467
All brushless machines 19 to 26 kW	5.5A P/N: 54450
All brushless machines 21 to 41 kW	6.0A P/N: 48505
All brushless machines 45 to 100 kW	4.5A P/N: 48476
All brushless machines over 100 kW	4.5A P/N: 48476

**TABLE C – AVR/ELECTRONIC GOVERNOR CONTROLLER DATA**

All 60 Hz machines with Generac alternators use automatic voltage regulator (AVR)	P/N: 67680
All 50 Hz machines with Generac alternators use automatic voltage regulator (AVR)	P/N: 92952
Barber Colman 12V 2500-5000 Hz electronic governor controller	P/N: 67709
Barber Colman 24V 2500-5000 Hz electronic governor controller	P/N: 67710
Barber Colman 12V 5000-9500 Hz electronic governor controller	P/N: 67711



# Appendix 4 – Exploded Views and Parts Lists

## E Option Control Panels

### Control Panel (Units 400 kW and Larger) – Drawing No. C3879-A

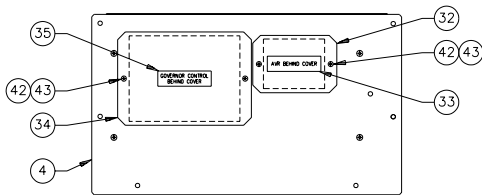
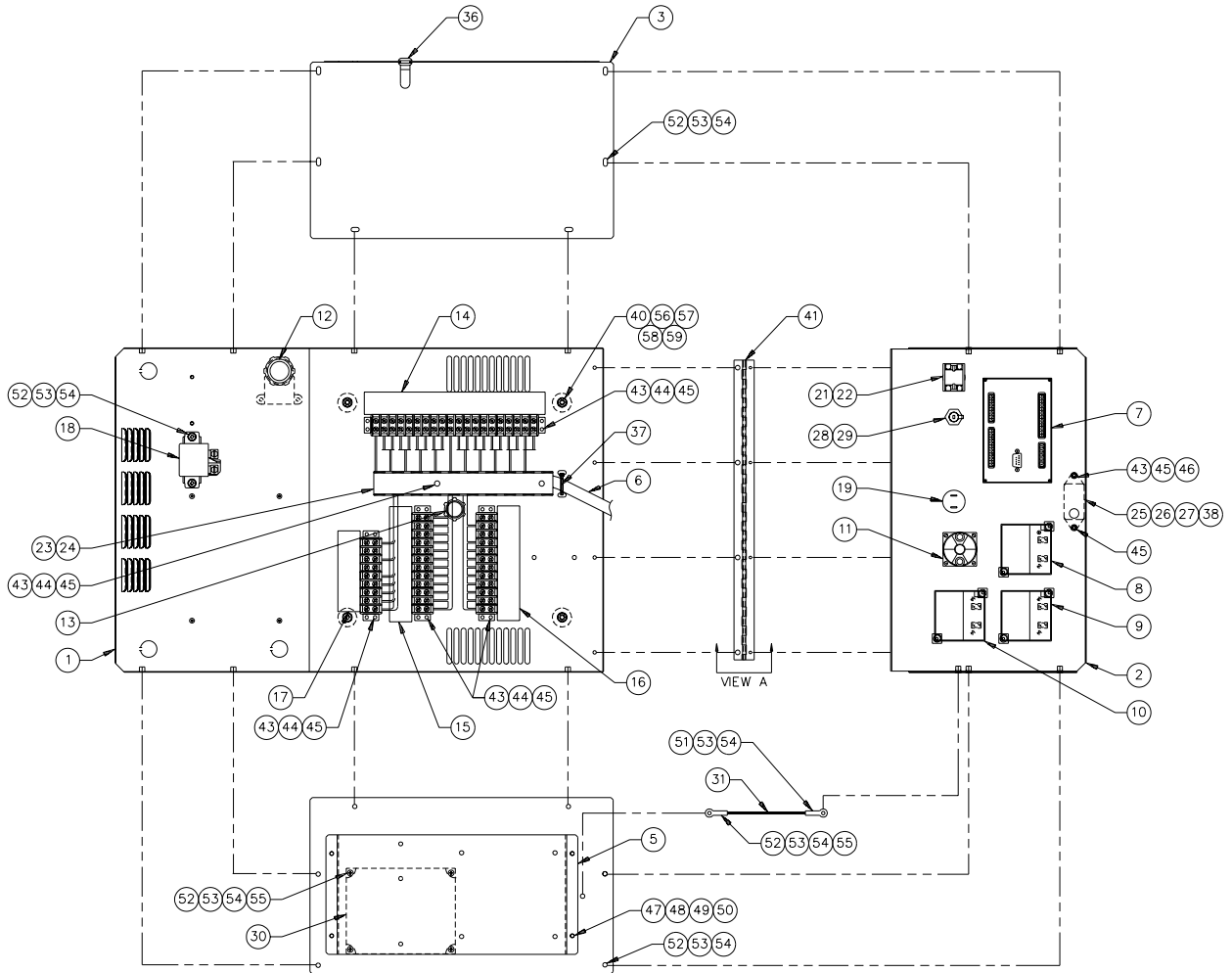

CONTROL PANEL LEFT SIDE  
OUTSIDE VIEW

SLOT #	WIRE #
1	0
2	1
3	2
4	4
5	S1
6	6
7	S15
8	S2
9	S16
10	57
11	S3
12	58
13	59
14	178
15	183

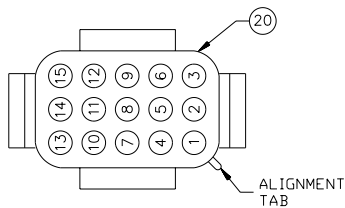

DETAIL 1  
WIRE NUMBERS/LOCATIONS  
FOR LOWER PANEL  
HOUSING SOCKET  
SCALE: NONE  
REAR VIEW

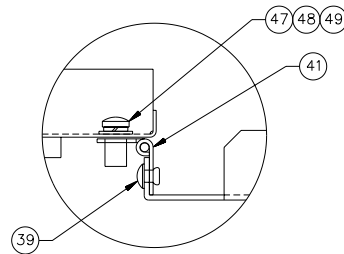

VIEW A  
HINGE ASSEMBLY  
SCALE: NONE

## Appendix 4 – Exploded Views and Parts Lists

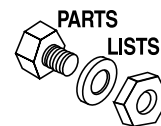

### E Option Control Panels Control Panel (Units 400 kW and Larger) – Drawing No. C3879-A

ITEM	PART NO.	QTY.	DESCRIPTION	ITEM	PART NO.	QTY.	DESCRIPTION
1	C2616	1	CONTROL PANEL BOTTOM	30	67710	1	ELECTRONIC GOVERNOR CONTROLLER
2	C3872	1	CONTROL PANEL FRONT	31	A2275	1	FRONT PANEL DOOR STOP
3	A6322	1	CONTROL PANEL RIGHT SIDE	32	A1441B	1	COVER PLATE, AVR
4	A6321	1	CONTROL PANEL LEFT SIDE	33	C1127	1	DECAL, AVR COVER
5	A6323	1	CHASSIS AVR/E GOV.	34	A1441C	1	COVER PLATE, E-GOV
6	C1377	1	HARNESS E PNL. MAIN	35	C1126	1	DECAL, E-GOV COVER
7	A4087	1	MASTER CONTROL BOX	36	30809	1	GROMMET 1/8-11/16
8	SEE NOTE	1	AMMETER	37	29333	1	TIE WRAP 7"
9	SEE NOTE	1	VOLTMETER AC	38	74130	1	LUG, PIN 4MM 22/18
10	SEE NOTE	1	FREQUENCY METER	39	36261	4	POP RIVET
11	74386	1	VOLT/AMP SWITCH	40	40479	4	VIBRATION DAMPENERS
12	A9234	1	90° CONNECTOR 1"	41	A2273	1	HINGE
13	34616	1	STRAIGHT CONNECTOR 3/4"	42	36901	4	#6-32 X 3/8" PPHMS
14	C3207	1	DECAL, TERMINAL STRIP TB1	43	22155	18	#6/M3 LOCK WASHER
15	A6576	1	DECAL, TERMINAL STRIP TB2	44	22985	12	#6/M3 FLAT WASHER
16	C3208	1	DECAL, TERMINAL STRIP TB3	45	C2428	14	#6-32 X 1/2" TAPTITE
17	C3206	1	DECAL, TERMINAL STRIP TB4	46	22188	1	#6-32 HEX NUT
18	C4110	1	RELAY 24V W/DIODE 50 A	47	36918	8	#8-32 X 1/2" PPHMS
19	61286	1	AUDIBLE ALARM	48	22264	8	#8/M4 LOCK WASHER
20	55089	1	HOUSING SOCKET 15 - CKT	49	38150	8	#8/M4 FLAT WASHER
21	98426A	1	EMERGENCY STOP SWITCH	50	22471	4	#8-32 HEX NUT
22	98426C	3	CONTACT, EMERGENCY STOP SWITCH	51	33120	1	#10-32 X 3/8" HHMS
23	91472	9.5"	WIRE DUCT 1" X 1.5"	52	33121	17	#10-32 X 1/2" HHMS
24	91472A	9.5"	WIRE DUCT COVER 1"	53	22152	20	#10/M5 LOCK WASHER
25	83287	1	PANEL LIGHT W/O BULB	54	23897	20	#10/M5 FLAT WASHER
26	83288	1	PANEL LIGHT BULB (24VDC)	55	22158	7	#10-32 HEX NUT
27	70082	1	LIGHT BLOCKER	56	22287	4	1/4-20 X 3/4" HHCS
28	32300	1	FUSE HOLDER	57	22097	4	1/4/M6 LOCK WASHER
29	22676	1	FUSE 15-A	58	22473	4	1/4/M6 FLAT WASHER
				59	47246	4	1/4 FLAT WASHER SPECIAL
				*	A5705	1	INTERNAL MODULE FUSE, 5A (NOT SHOWN)

NOTE: Contact your nearest Generac Authorized Service Dealer at (800) 333-1322 for the correct part number for your unit.

**GENERAC® POWER SYSTEMS, INC.**

P.O. BOX 8  
WAUKESHA, WI 53187

**Part No. A7605**

**Revision 1 (10/28/99)**

**Printed in U.S.A.**

# E-PANEL DISPLAY MAP

