

# GENERAC®

POWER SYSTEMS, INC.

## Operator's Manual

"E" Option Control Panels

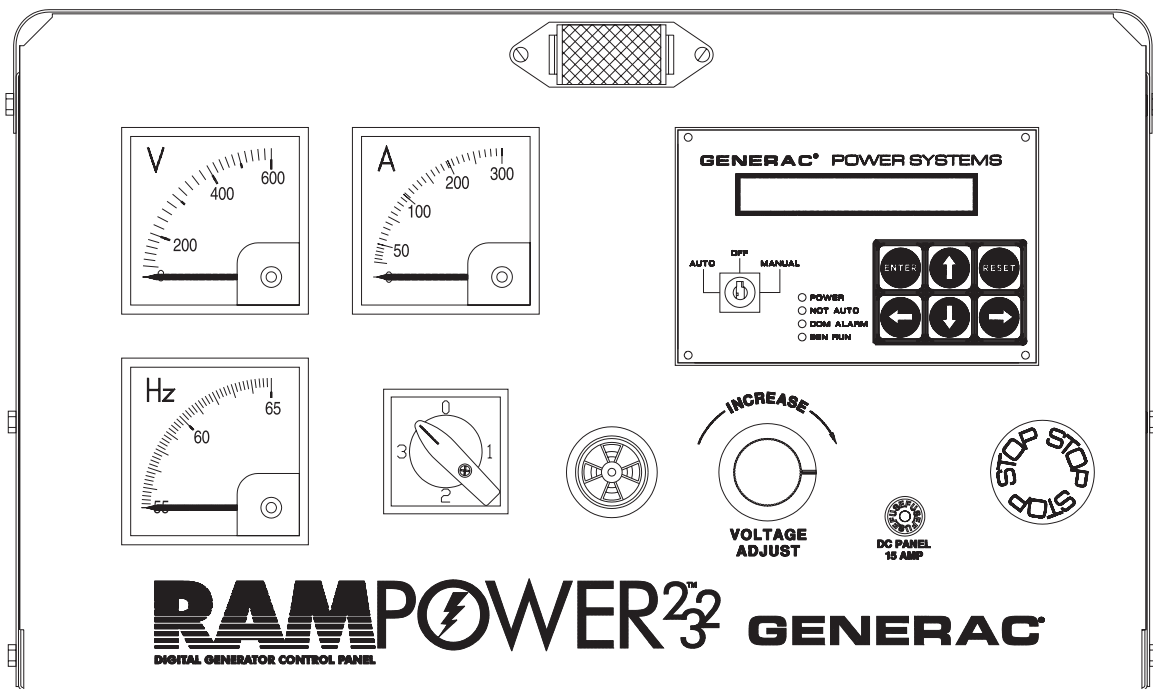

This manual contains standard drawings and schematics.  
For specific drawings, please refer to the Owner's Manual of the unit.

This manual should remain with the unit.



## Important Safety Instructions

### E Option Control Panels

**SAVE THESE INSTRUCTIONS** – *The manufacturer suggests that these rules for safe operation be copied and posted in potential hazard areas. Safety should be stressed to all operators and potential operators of this equipment.*

Study these SAFETY RULES carefully before installing, operating or servicing this equipment. Become familiar with this manual and all literature pertaining to your generator set and related equipment. This equipment can operate safely, efficiently and reliably only if it is properly installed, operated and maintained. Many accidents are caused by failing to follow simple and fundamental rules or precautions.

Generac cannot possibly anticipate every possible circumstance that might involve a hazard. The warnings in this manual, and on tags and decals affixed to your equipment are, therefore, not all-inclusive. If you use a procedure, work method or operating technique Generac does not specifically recommend, you must satisfy yourself that it is safe for you and others. You also must make sure the procedure, work method or operating technique that you choose does not render the equipment unsafe.

### **GENERAL HAZARDS**

- For safety reasons, Generac recommends that this equipment be installed and serviced by a Generac Authorized Service Dealer or other competent, qualified electrician or installation technician who is familiar with applicable codes, standards and regulations. The operator also must comply with all such codes, standards and regulations.
- When working on this equipment, remain alert at all times. Never work on the equipment when you are physically or mentally fatigued.
- Inspect the equipment regularly, and promptly repair or replace all worn, damaged or defective parts using only factory-approved parts.
- Before performing any maintenance on the generator or any related equipment, disable the generator to prevent accidental start-up. Remove the control panel fuse and then disconnect the battery cables by removing the one indicated by a NEGATIVE, NEG or (–) first. To re-enable the generator, reconnect the battery cables connecting the one indicated by a NEGATIVE, NEG or (–) last, then re-install the control panel fuse.

### **ELECTRICAL HAZARDS**

- Generators produce dangerous electrical voltages and can cause fatal electrical shock. Avoid contact with bare wires, terminals, connections, etc., while the generator and related equipment are running. Ensure all appropriate covers, guards and barriers are in place before operating the equipment. If you must work around an operating unit, stand on an insulated, dry surface to reduce shock hazard.

**Generac® Power Systems, Inc.**

- Do not handle any kind of electrical device while standing in water, while barefoot, or while hands or feet are wet. DANGEROUS ELECTRICAL SHOCK MAY RESULT.
- If people must stand on metal or concrete while installing, operating, servicing, adjusting or repairing this equipment, place insulative mats over a dry wooden platform. Work on the equipment only while standing on such insulative mats.
- Wire gauge sizes of electrical wiring, cables and cord sets must be adequate to handle the maximum electrical current (ampacity) to which they will be subjected.
- Before installing or servicing this equipment, make sure that all power voltage supplies are positively TURNED OFF at their source. Failure to do so will result in hazardous and possibly fatal electrical shock.
- When installed with an automatic transfer switch, the generator may crank and start anytime without warning. To prevent injuries caused by sudden start-up, disable the generator's automatic start circuit before working on or around the unit. Then, place a "Do Not Operate" tag on the generator control panel and on the transfer switch.
- In case of accident caused by electric shock, immediately shut down the source of electrical power. If this is not possible, attempt to free the victim from the live conductor. AVOID DIRECT CONTACT WITH THE VICTIM. Use a nonconducting implement, such as a rope or board, to free the victim from the live conductor. If the victim is unconscious, apply first aid and get immediate medical help.
- Never wear jewelry when working on this equipment. Jewelry can conduct electricity resulting in electric shock, or may get caught in moving components causing injury.

### **FIRE HAZARDS**

- For fire safety, the generator and related equipment must be installed and maintained properly. Installation always must comply with applicable codes, standards, laws and regulations. Adhere strictly to local, state and national electrical and building codes. Comply with regulations and the Occupational Safety and Health Administration (OSHA) has established. Also, ensure that the equipment is installed in accordance with the manufacturer's instructions and recommendations. Following proper installation, do nothing that might alter a safe installation and render the unit in noncompliance with the aforementioned codes, standards, laws and regulations.

**Safety Rules .....Inside Front Cover**  
**Section 1 — General Information.....2**  
Overview .....2  
Engine Control .....2  
E Option Control Module .....2  
Alarms.....4  
Alarm Processing.....5  
Programmable Parameters .....6  
E Panel Modem Setup Procedure .....9  
E Panel RS 232 Cables .....9  
Additional Panel Components .....10  
Checking/Replacing the E Panel Control Module  
    Internal Fuse .....11  
User Programmable Inputs .....11  
Wiring Examples .....12  
Programming Examples .....13  
**Section 2 — Operation.....14**  
Output Function Table .....14  
E Panel Master Control Box Configuration Settings15  
E Panel Display Map .....18

**Section 3 — Troubleshooting and  
Diagnosis .....20**  
Oil Pressure Sensing .....20  
Low Coolant Level .....22  
Coolant Temperature Sensing .....25  
Oil Temperature Sensing .....27  
AC Voltage Display .....29  
RPM Sensor and Engine Speed Alarms .....29  
Engine Does Not Crank .....31  
Overcrank.....34  
**Appendix — Phoenix and  
Deutsch Connectors .....35**  
**Section 4 — Glossary.....38**  
E Control Panel Definitions .....38  
**Section 5 — Electrical Data .....39**  
E Panel Drawing Application Matrix .....39  
**Section 6 — Exploded Views and  
Parts Lists .....60**  
**Section 7 — Notes .....76**

**AUTHORIZED SERVICE DEALER LOCATION**

To locate the GENERAC AUTHORIZED SERVICE  
DEALER nearest you, please call this number:

**1-800-333-1322**

DEALER LOCATION INFORMATION  
CAN BE OBTAINED AT THIS NUMBER.

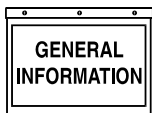

## OVERVIEW

The “E” option control panel is a programmable engine control and monitoring system. It allows the user to customize the generator starting and running sequence, monitor engine parameters and configure the alarms. This can be done either through its own control module, featuring liquid-crystal display (LCD) and keypad, or using a PC and RS232 serial communications. The module includes user programmable inputs and outputs that allow it to be tailored to a vast range of applications. All of the setup information is stored in nonvolatile (permanent) memory.

## ENGINE CONTROL

The module has a three-position selector switch that selects between “Auto” mode, “Off” and “Manual” start mode. When the switch is in the OFF position, the generator will not start, and it will stop if it is running. When the switch is turned to MANUAL, the generator will start immediately and will continue to run until the switch is turned to the OFF position or a shutdown alarm is activated. With the switch in the AUTO position, the generator will wait for either the remote start contacts to close or for a start command to be sent from the serial link. The generator will run until the remote start contacts open, a stop command is sent down the serial link, a shutdown alarm is activated or the switch is turned to the OFF position. The remote start contacts always will have priority over the serial link commands so that the serial link cannot stop the generator if the remote start contacts are closed. When GenLink<sup>®</sup> software, which may be obtained from a Generac Authorized Service Dealer, is connected to the E panel via modem, the panel will monitor the connection to ensure that the line has not dropped. If the E panel detects that the line has been dropped, it will disconnect the modem so that it is ready for another incoming call. If the generator had been started via the modem connection, then it will be stopped immediately unless the remote start contacts are closed or the generator is in manual. However, if the GenLink<sup>®</sup> software disconnected cleanly (as a result of a user command) with the generator running, then the generator will continue to run for another three hours unless it receives a stop command.

When a start command is received, the engine preheat will be engaged, if it is selected. The user can program the preheat to engage for a programmable time before engaging the starter motor, to engage while the engine is attempting to start, or to do both. In order to protect the engine from trying to start while it is already running (if the rpm sensor is damaged), an alarm is generated if there is oil pressure when the start command is sent. An alarm also is generated if there is a voltage output from the generator but the rpm sensor detects zero engine speed.

The user can program the length of time that the starter motor is engaged during a start attempt. After the first attempt, the generator will pause for a programmable length of time before the next attempt. The number of attempts also is programmable, after which the failed to start alarm is activated.

The user can program a warm-up time that is active after the generator has started. This could be used in conjunction with a programmable relay output to inhibit the transfer switch from applying load until the generator is ready. The warm-up time can be set to zero if this function is not required. This timer is separate from the alarm hold off timer, which allows the generator to run for a time before certain alarms (such as low oil pressure) are active.

If the generator is in the AUTO mode and a stop command is received, a programmable cool-down timer can be used to keep the generator running with no load for a fixed time. This also can work in conjunction with a relay output to inhibit the transfer switch. If the timer is set to zero, this function is disabled. If the selector switch is turned to OFF, then the generator will stop immediately without waiting for the cool-down time.

Certain alarm functions are designated as shutdown alarms. These alarms will stop the generator and inhibit it from starting until the alarm condition has cleared and the alarm has been reset.

## E OPTION CONTROL MODULE

### ◆ OVERVIEW

The LCD on the front of the module (Figure 1.1) features a 24-character by two-line display screen that will show one of seven pages. There is a keypad with six keys that are used for operating the display and selecting the various pages. A key-activated switch allows the user to select whether the generator is in the “Auto” mode, “Off” mode or “Manual” run mode. Four LEDs indicate the following conditions:

- “Power” – Battery power is OK.
- “Not Auto” – The generator is not in the automatic mode.
- “Com Alarm” – A common alarm condition has occurred.
- “Gen Run” – The generator is running.

#### NOTE:

**The “Power” LED will go out immediately if the battery voltage dips below the alarm limit, but the alarm will not be triggered unless the voltage is low for more than five minutes.**

**Figure 1.1 – Control Module Layout**

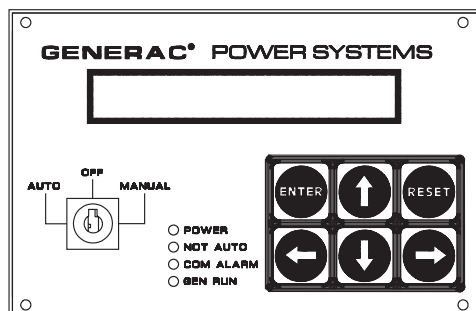

### ◆ KEYPAD

The keypad consists of six keys labeled as follows: ↑ (up), ↓ (down), ← (left), → (right), Enter, and Reset. The left and right arrow keys are used to select the different pages on the display. The up and down arrow keys are used to scroll between options within a page. They also are used for selecting characters when the user is entering messages or parameters for the alarms. The left and right arrow keys move the cursor when the user is entering data. The enter key takes the user into a page on the display to change data (when applicable) and also accepts data that has been entered. It also is used to accept an alarm. The reset key ignores data that has been entered and returns the original value. It also is used to return from the parameter entry mode once the user has finished changing the data, and to reset any latched alarms that have cleared.

### ◆ DISPLAY

The display is organized into a series of pages, each page displays information about the status of the generator. For example, the “Alarm Status Message Page” displays the highest priority current alarm or status condition. The user will be able to scroll between the pages using the left and right arrow keys. Certain actions also cause the display to change pages, e.g., when an alarm becomes active, the display automatically will go to the alarm status page and display the alarm message.

The back light for the display is normally off. If the user presses any key, the back light will come on automatically and remain on for five minutes after the last key was pressed. It also will come on if any status message is current, which means the display will switch to the alarm status page. The back light will flash when an alarm or shutdown message is active, and the audible alarm will sound.

When the display is showing certain pages, the user is able to scroll between relevant items within the page using the up and down arrow keys. For example, if the display is showing the “Alarm Log Page,” the user can use the up and down arrow keys to scroll between the entries on the alarm log. A description of each page is given below.

#### ✧ Software Version Page

This page displays the software revision. Pressing the enter key in this page will perform a display and LED test.

#### ✧ Generator Command Page

This page displays the command sent to the generator. The possible commands are as follows:

- Generator switched off
- Generator in manual mode
- Generator in auto mode – stop command
- Generator in auto mode – remote run command
- Generator in auto mode – serial link run command

#### ✧ Generator Status Page

This page displays the current status of the generator. Options will be as follows:

- Stopped – ready to run
- Stopped – start inhibit active
- Pre-heating (with timer counting down)
- Attempting to start (with timer counting down and number of attempts)
- Pausing before start attempt (with timer counting down and number of attempts)
- Started – running up to speed
- Warming up
- Ready to accept load
- All alarms enabled
- Cooling down
- Stopping
- Stopped due to alarm

If the user has not pressed a key for some time, any change in status will cause this page to be displayed provided that there are no active alarms or status messages from other inputs. If an alarm condition occurs, the alarm status page will be displayed automatically.

#### ✧ Alarm Status Message Page

This page displays alarm messages and programable status messages. Messages are displayed according to priority, with the shutdown alarms having highest priority, and status messages having lowest priority.

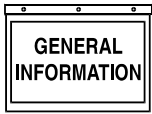

If an alarm becomes active, the display will switch to this page and display the highest priority alarm message. The back light and alarm LED will flash, and the audible alarm will be activated. The user must press the enter key to accept the alarm, at which time the back light will be on continuously. If the alarm is non-latching, the alarm message will clear as soon as the condition is cleared. If the alarm is a latching alarm, then the user must press the reset key to clear the message. Once a message has cleared, the display will show the next priority alarm message.

After an alarm has been accepted, the user is able to scroll through other active alarm and message screens using the up and down arrow keys.

#### ❖ **Alarm Log Page**

This page displays the last 50 alarm messages. When the user selects this page, it displays the latest alarm message. Pressing the up or down arrow keys will allow the user to scroll up and down the list of messages.

#### ❖ **Instrumentation Page**

This page displays one of the analog signal values. Pressing the up or down arrow keys will scroll to other analog display screens.

#### ❖ **Parameter Entry Page**

This page allows the user to modify the various set points and programmable options. See the “Programmable Parameters” section of this manual for more specific option information. The user must press the Enter key when this page is displayed and will then be prompted for a password. The password is a six-digit number and the default value is 000000. However, the user will be able to change the password. Digits will be selected using up and down arrow keys, and the cursor will be moved by the left and right arrow keys. When the user presses the Enter key, the password will be checked. If the password is correct, the display will show one of the data entry screens.

There are four parameter entry menus: “Engine Parameter,” “System Alarm,” “Digital I/O” and “Analog Input.” The user will be able to scroll through the various parameters in each menu using the up and down arrow keys. The left and right arrow keys are used to switch between the four menus. When a parameter that requires changing is displayed, the user presses the Enter key to enable data entry. A cursor will appear at the first character that can be altered. The user can then change the character using the up and down arrow keys. The user can move to the next character or previous character using the left and right arrow keys. Pressing the Enter key will accept the new setting. Pressing the Reset key will ignore the new setting.

If an alarm condition occurs when the user is entering data, the data will be ignored, and the display will show the alarm screen. If a status condition occurs when data is being entered, the display will not change.

Once the user has finished entering data by pressing the Enter key, pressing the Reset key will allow the user to select other pages using the left and right arrow keys.

## **ALARMS**

All analog channels have alarms associated with them. There is also a coolant level alarm, an emergency stop alarm and eight user definable inputs that can be used to generate alarms. Alarms can be status messages, non-latching alarms, latching alarms or shutdown alarms. When a new alarm condition occurs, the alarm LED and the display back light will flash. Also, the alarm relay contacts will close (operating the audible alarm), and the display will show the alarm message. The user will be able to accept the alarm (turn off the audible alarm) from the keypad, and if the alarm condition has cleared, he or she also will be able to clear the alarm. Non-latching alarms will clear themselves if the alarm condition is no longer present. Latching alarms require the user to clear the alarm from the keypad even if the alarm condition is no longer present. Shutdown alarms are similar to latched alarms, but they also cause the generator to stop and will not allow it to start again until the key-switch has been turned to the OFF position to reset the alarm. Status messages are similar to non-latching alarms except that they do not activate the alarm relay or the alarm LED and are not recorded on the alarm log.

Alarms can be always active, immediately active when the generator is commanded to run, or active after the hold off timer has expired. This timer delays the operation of certain alarms until a programmable time after the engine has started. Some alarms allow the user to define the type of alarm and when it is active.

The following chart is a summary of the alarms and the programmable options:

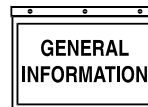

Alarm Message	Alarm Active Options	Alarm Type Options
Pre-Low Oil Pressure Warning	Hold Off	Non-Latch
Low Oil Pressure Shutdown Alarm	Hold Off	Shutdown
Pre-High Coolant Temp. Warning	Hold Off	Non-Latch
High Coolant Temp. Shutdown Alarm	Hold Off	Shutdown
Low Coolant Temp. Warning	Always	Non-Latch
Pre-High Oil Temp. Warning	Immediate, Hold Off, Disabled	Non-Latch
High Oil Temp. Shutdown Alarm	Immediate, Hold Off, Disabled	Shutdown
Low Battery Voltage Warning*	Always	Non-Latch
Overspeed Alarm	Immediate	Shutdown
Underspeed	Hold Off	Status, Non-Latch, Latch, or Shutdown
Overcrank Alarm	Immediate	Shutdown
Over Voltage	Hold Off	Status, Non-Latch, Latch, or Shutdown
Under Voltage	Hold Off	Status, Non-Latch, Latch, or Shutdown
Over Frequency	Hold Off	Status, Non-Latch, Latch, or Shutdown
Under Frequency	Hold Off	Status, Non-Latch, Latch, or Shutdown
High Fuel Warning	Always, Disabled	Non-Latch
Low Fuel Warning	Always, Disabled	Non-Latch
Low Fuel Shutdown Alarm	Always, Disabled	Shutdown
User Analog Alarms**	All Options Available	All Options Available
Low Coolant Level Alarm	Hold Off	Shutdown
Emergency Stop	Always	Shutdown
RPM Sensor Failure Alarm	Always	Shutdown
Start Inhibit – Oil Pressure	Immediate	Shutdown
Oil Pressure Sensor Failure	Always	Shutdown
Oil Temp. Sensor Failure	Always, Disabled	Shutdown
Coolant Temp. Sensor Failure	Always	Shutdown
User Digital Input Alarms***	All Options Available	All Options Available
High Battery Voltage Warning	Always	Non-Latch

\* Battery voltage must be below alarm limit for 5 minutes to trigger alarm.

\*\* Each user analog input channel has a high and low alarm.

\*\*\* Each user digital input can be programmed to trigger an alarm on high or low level.

## ALARM PROCESSING

### ◆ INPUT ALARM FUNCTIONS

The E option panel will monitor the status of the analog and digital inputs, and generate alarm messages as required. Digital alarms and user-defined analog alarms are fully programmable. The user is able to select the type of alarm, the state of the input that will trigger the alarm, and the alarm message when it is active. The configurations are defined as follows:

#### ✧ Alarm Active

The user is able to select when the alarm is active. The options will be as follows:

- **Disabled:** If this option is selected, the alarm is disabled and has no effect.
- **Always:** With this option selected, the alarm is active regardless of the state of the generator.
- **Immediate:** In this mode, the alarm is not active when the generator is stationary. It becomes active as soon as the generator starts to crank and remains active until the generator stops.
- **Hold Off:** This option waits until a preset time after the generator is running before becoming active. The hold off time can be set by the user. Note that the hold off time is common to all alarms.

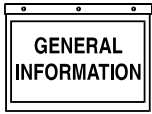

## ◆ ALARM TYPE

---

### ◇ Status

This type of alarm will display a message on the screen. The message will not be logged. This is the lowest priority of alarm types.

### ◇ Warning – Non-Latched

This type of warning will activate the audible alarm, and flash the alarm LED and display back light. The associated message will be displayed on the screen. When the user accepts the warning (by pressing the Enter key), the back light will stop flashing, and the alarm LED will be on continuously. The message will be displayed on the alarm screen, but the user will be able to scroll through other screens. The LED and message will clear when the warning condition clears. This type of warning is logged.

### ◇ Alarm – Latched

This type of alarm will act similarly to the non-latched warning, except that the alarm does not clear when the alarm condition clears. When the alarm condition occurs, the audible alarm sounds, the LED and back light flash as before, and the user must accept the alarm to stop them. The alarm will continue to be displayed on the screen even after the alarm condition has cleared. The user must either press the Reset key or turn the key-switch to the OFF position to clear the alarm after the alarm condition has cleared. This type of alarm is logged.

### ◇ Shutdown

This type of alarm will act similar to the latched alarm, but it also will stop the engine when the alarm condition occurs. It can be reset only by turning the key-switch to the OFF position. All shutdown alarms are latching, and this type of alarm is logged.

### ◇ Alarm Status

This is the value at which the alarm is active. For analog alarms, it is a number corresponding to the alarm limit. Digital alarms are either “normally open” or “normally closed,” and an alarm is generated when the input is not in the normal state.

### ◇ Alarm Message

Each alarm will have a message associated with it. The analog alarm messages will be preset, and the digital alarm messages and user-defined analog messages will be entered via the keypad or the serial link.

## ◆ OTHER ALARMS

---

### ◇ Overcrank

This alarm is unlike other alarms as it is not associated with an analog or digital signal. The user is able to define the number of crank attempts, the length of each crank attempt and the rest time between cranks. After the last attempt has been made, an overcrank alarm will be generated. The user must turn the key-switch to the OFF position to clear the alarm.

### ◇ Coolant Level

This alarm is generated by the coolant level detector. This device senses whether coolant is present or not. It has no user-definable level setting and is a shutdown alarm that is active after the hold off time. There are no user-definable parameters for this alarm.

## PROGRAMMABLE PARAMETERS

The E option panel allows the user to configure various options to control the generator starting and stopping cycles, and the way that the alarms operate. Parameters are entered either from the control module or via the serial link. A description of the programmable parameters follows:

### ◆ PREHEAT ENABLED

---

This parameter determines how the preheat function works. The preheat can be fully disabled, enabled before starting only (for the duration of the preheat time), or before and during starting (for the duration of the preheat time and also while the starter is engaged). Note that if the user wishes to engage the preheat during starting but not to have a preheat before starting, it is possible to set the preheat time to zero.

### ◆ PREHEAT TIME

---

When a start command is received, some engines require preheating before the generator attempts to start. When the preheat function is enabled, this parameter allows the user to determine the time that the preheat contact closes before activating the starter solenoid.

### ◆ START TIME

---

Once a start command has been received and the preheat time has expired (if enabled), the starter solenoid will be engaged. This parameter allows the user to determine how long the starter solenoid is engaged before the start attempt is regarded as having failed. If the generator does not start within this time, the generator will wait for a preset time before attempting to start again. The user also can program the number of start attempts the generator tries.

### ◆ PAUSE TIME

If the generator does not start within the programmed start time, it will pause before trying to start again. This parameter determines the length of that pause.

### ◆ START ATTEMPTS

This parameter determines the number of times that the generator tries to start. If the generator has not started after this number of attempts, an alarm is generated.

### ◆ STARTER DISENGAGE SPEED

While the starter is engaged, the engine speed is monitored. Once it reaches this value, the starter motor is disengaged, and the engine is regarded as having started.

### ◆ HOLD OFF TIME

Once the engine has started, some alarm functions (such as low oil pressure and under speed) are not activated immediately since the engine must be given time to reach a stable condition. This parameter determines the time that elapses before the hold off alarms are activated.

### ◆ COOL-DOWN TIME

It is sometimes desirable to run the generator for a given time with no load before stopping to allow the engine to cool down. This parameter determines the length of time that the generator continues to run after a stop command is sent in AUTO mode. Note that if the key-switch is turned to the OFF position when the generator is running, it will stop immediately regardless of this setting. This value also should be set to zero if this function is controlled by the transfer switch.

### ◆ LOAD ACCEPT VOLTAGE AND FREQUENCY

Once the generator has started, the voltage and frequency will ramp up until they reach the values at which the generator can accept load. These parameters allow the user to set the values. The values should be set slightly lower than the nominal values to allow for a margin of error in the regulator and governor settings. Once the values have been reached, the warm-up timer is started.

### ◆ WARM-UP TIME

Some applications require that the generator is allowed to run for a given time before a load is applied. This parameter allows the user to set that time. Note that if this function is controlled elsewhere (e.g., within a transfer switch), this time should be set to zero. The generator is ready to accept load when this timer expires. This parameter can be assigned to an output relay.

### ◆ VOLTAGE SCALING FACTOR

The voltage scaling factor is used to scale the sensing voltage applied to CON4-4 and CON4-6.

On generators manufactured prior to the second quarter of 2000: Sensing voltage was measured from line-to-line, so the scaling factor was primarily set to 1.0. On generators manufactured starting the second quarter of 2000: Sensing voltage is measured from the frequency meter, in this case the scaling factor is used so the “E” panel displays line-to-line voltage. This scaling factor can also be used to “calibrate” the “E” panel display.

### ◆ FLYWHEEL TEETH

This parameter holds the number of flywheel teeth. This value is used to determine the engine speed from the magnetic pickup signal.

### ◆ USER-DEFINED OUTPUT FUNCTIONS

There are three user-defined outputs, and the preheat output also can be used as a user-defined output if the preheat function is disabled. Each output can be programmed to signal that an alarm is active, to indicate one specific alarm or input condition, to indicate the status of the key-switch, or to indicate the current status of the generator. These relay contacts can be used to switch up to 30 volts AC or DC at 1 amp.

Programming example for user output #2 to be active on any generator alarm shutdown:

1. Press the left or right arrow key until the display reads “Parameter entry” and press ENTER.
2. Enter your password and press ENTER.
3. Use the left and right arrow keys to find the “Digital I/O Menu”.
4. Use the up and down arrow keys to locate “Output 2 Function”. The bottom line of the display will read the current setting. Press ENTER.
5. Use the up and down arrows to scroll through the list until “Generator Alarm Shutdown” is displayed in the bottom line. Press ENTER.
6. User output #2 is now programmed to become active (relay energized) on any generator shutdown alarm.
7. Press RESET. This exits the programming mode and returns you back to the parameter entry screen.

#### NOTE:

**See the “Output Function Table” on Page 14 and the “E” Panel Display Map on pages 18-19 for more detail.**

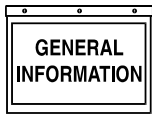

#### ◆ ANALOG INPUT SCALING FACTORS

The two user-defined analog inputs can be scaled so that the display uses meaningful values rather than the voltage level at the input. The user enters the value to be displayed when the input voltage is zero and when it is at the maximum value. (An analog input to the E panel is a voltage sourced input with a zero- to 10-volt range.) All alarm settings are based on this scaling, and the instrumentation display shows the input value based on this scaling too.

#### ◆ ANALOG INPUT MESSAGES

This is a message up to 24 characters long that is displayed on the instrumentation display when the corresponding value is being shown.

#### ◆ ANALOG INPUT ALARM MESSAGES

There is a user-definable message for each alarm condition on each analog input. This message is shown on the alarm display when the alarm condition is active and is stored in the alarm log.

#### ◆ ANALOG INPUT ALARM SETTINGS

Each analog input has two alarms associated with it. One is activated when the input value is higher than the high set-point, and the other is active when the input is lower than the low set-point. The user also can define when the alarm is active (or disable it) and the severity of the alarm (from simply displaying a status message to shutting down the generator – see “Alarm Processing” on Page 5).

#### ◆ DIGITAL INPUT ALARM SETTINGS

Each digital input also can generate an alarm. The user can program the alarm message, the input state that generates the alarm, when the alarm is active, and the alarm type. A digital input to the E panel is NOT a voltage sourced input, but a dry contact closure to ground. Voltage never should be sourced to a digital input. The signal options to a digital input are as follows:

- **Open:** This signal is an open circuit.
- **Closed:** This signal is a contact closure to ground.

#### ◆ OIL PRESSURE ALARMS

The oil pressure input has two associated alarm functions. The pre-low oil pressure warning is a non-latched, hold off alarm with a user-definable set-point. The low oil pressure shutdown is a shutdown, hold off alarm with a user-definable set-point. The shutdown alarm set-point should be the lowest of the two settings so that the user will have some warning of a low oil condition before the generator is shut down.

#### ◆ OIL TEMPERATURE ALARMS

The oil temperature has a non-latched warning and a shutdown alarm associated with it. The set-points are programmable, and the alarms can be immediate, hold off or disabled.

#### ◆ COOLANT TEMPERATURE ALARMS

The coolant temperature input has three associated alarms. The pre-high coolant temperature alarm is a non-latched, hold-off alarm. The high coolant temperature alarm is a shutdown, hold-off alarm. The low coolant temperature warning is a non-latched, always active alarm. Set-points for each alarm are programmable.

#### ◆ BATTERY VOLTAGE ALARMS

The low battery voltage warning set-point is programmable. The warning will be activated if the battery voltage is below this value for more than five minutes. This is a non-latched, always active alarm. Note that the “Power” LED on the front panel is extinguished immediately if the battery voltage is less than this value. The high battery voltage alarm set-point is also programmable. The warning is active immediately when the battery voltage is higher than this value.

#### ◆ ENGINE SPEED ALARMS

The user can program the overspeed and the underspeed alarm. The overspeed alarm is an immediate shutdown alarm. Underspeed is a hold off alarm that can either be non-latched, latched or shutdown.

#### ◆ GENERATOR VOLTAGE ALARMS

An alarm can be generated for high voltage and low voltage. The set-points are user-definable, and the alarms can be either non-latching, latching or shutdown.

#### ◆ GENERATOR FREQUENCY ALARMS

An alarm can be generated for high frequency and low frequency. The set-points are user-definable, and the alarms can be either non-latching, latching or shutdown.

#### ◆ FUEL LEVEL ALARMS

Alarms can be generated by an optional fuel level sensor. The high fuel level warning is non-latching. There is also a low fuel level warning that is non-latching and a low fuel shutdown alarm. Each of these alarms has a set-point and can be always active or disabled.

## E PANEL MODEM SETUP PROCEDURE

### NOTE:

Generac only supports the US Robotics 56k V90 Sportster modem for connection of the “E” Panel to the phone line. Other modems may work in this application, but have not been tested by Generac.

1. Set modem Dip switches as shown in Figure 1.2. Power cycle the modem (turn modem off, then on).
2. Connect the cable between the “E” panel and the modem (see Figure 1.4).
3. Set the “E” panel for “modem connection and setup”. Power cycle the “E” panel (remove and relace front panel fuse).
4. In GenLink, select the proper setup string for the modem at the PC end (not the “E” panel).

Figure 1.2 — US Robotics 56k V90 Sportster Dip Switch Settings

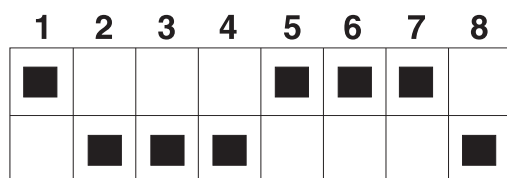

## E PANEL RS232 CABLES

The “E” panel can communicate via its RS232 port to a remote PC. The connection is made either directly to the serial port on a PC, or via a modem and telephone line.

The “E” panel has a 9-pin male “D” type connector, and is configured as DTE (Data Terminal Equipment). The serial ports on most PCs also have a DTE configuration, and are usually 9-pin “D” type male connectors. Most modems have a DCE configuration (Data Communication Equipment) and a 25-pin female connector.

Connecting an “E” panel directly to a PC requires a “Null Modem” connection. This can be achieved with either a null modem cable, or a standard serial cable with a null modem adapter. Figure 1.3 shows the required pin connections between the two cables for a 9-pin serial connector on the PC.

Figure 1.3 — “E” Panel to PC Cable Configuration

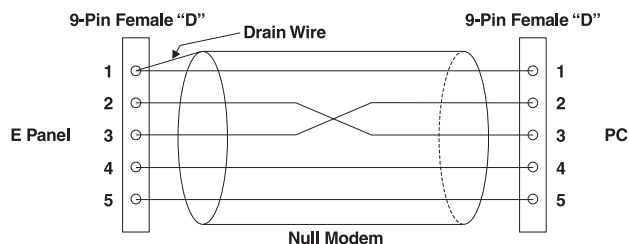

### NOTE:

Use shielded cable, 100 feet maximum in length. Connect the shield drain wire to Pin 1 on the E panel end only.

Connecting the “E” panel to a modem requires a standard modem cable. The cable supplied with the modem should work. If a longer cable is required, the connectors should be wired as shown in Figure 4.

Figure 1.4 — “E” Panel to Modem Cable Configuration

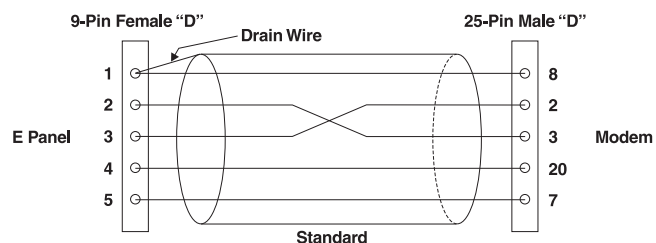

### NOTE:

The modem is not intended to be mounted inside the control panel. It should be mounted inside the enclosure (no vibration) or inside a nearby building or shelter if the generator does not have an enclosure.

### NOTE:

Use shielded cable, 100 feet maximum in length. Connect the shield drain wire to Pin 1 on the E panel end only.

## ◆ SERIAL COMMUNICATIONS

### ✧ Serial Communication Via Modem

(Also refer to the appropriate Genlink Manual)

The control panel has the ability to communicate to a PC via an RS232 serial port. The PC software will be able to interrogate the module. The user also will be able to program the parameters on the PC and download them to the module if using the Pro version. The user will be able to start and stop the generator if it is in AUTO mode.

The module does not have a built-in modem. However, software will include the ability to interface with an external modem. The user can initialize the modem from the panel. Generac offers a remote annunciator (models #'s 004391-0, 004392-0 and 004391-1, 004392-1) which allows the E panel to communicate with both a modem and a remote annunciator. See the Remote Annunciator Panel manual (part number 0A7450) for a complete description of these panels.

❖ Remote Annunciator Panel

(Refer to manuals 0A7450 and 0A9825)

The serial connections can be configured to allow the control panel to connect to a remote annunciator/remote relay panel, which is configured as RS485, to meet NFPA 110. Only one communication port is available for either a modem or remote annunciator.

NOTE:

The following diagram and instructions apply only to those units manufactured before January 2000. Units manufactured after January 2000 incorporate a selector switch on the back of the control module. This switch will allow selection of either RS232 or RS485 without opening the module.

❖ Altering the Serial Communications Setup

The E option control panel is capable of being used with either a modem or a remote annunciator/remote relay panel, depending on the configuration of the serial connections. The unit comes set up for connection to a modem (RS232). In order to use the control panel with a remote annunciator/remote relay panel (RS485), adhere to Figure 1.5 and the instructions that follow.

1. Remove harness retaining screws, then unplug all five wire harnesses from the back of the E panel control module.
2. Remove the four phillips head screws retaining the rear cover of the control module.
3. Open the back of the control module.
4. Locate the DB-9 wire harness that runs from the DB-9 connector on the back panel to the black header on the lower circuit board inside the control module.
5. Carefully remove the black connector from the header by pressing the locking tab and lifting up.
6. Insert the black connector into the RS485 header (J11). Make sure that the connector is fully inserted and that the locking tab snaps into place.
7. Replace the back panel and the four screws.

Figure 1.5 – E Panel Serial Communications Setup Modification

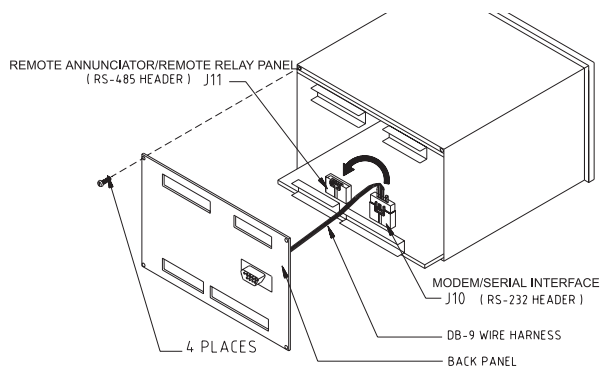

◆ USER PASSWORD

The user can set the password. This is a six-digit number and is initially set to 000000.

ADDITIONAL PANEL COMPONENTS

In addition to the control module, the E option panel contains the following components (see Figure 1.6):

◆ AC VOLTMETER

This meter indicates the generator AC output voltage. To determine the nominal rated AC voltage of the unit, refer to the unit's data plate.

NOTE:

Some generators are re-connectable to a variety of voltages. Some units may be equipped with a rotary "Voltage Selector Switch." Be sure to read the "Generator AC Lead Connections" section in the Owner's Manual.

◆ AC AMMETER

This meter indicates the current draw of connected electrical loads, in amps. Also see "Line-phase Selector Switch." For continuous operation, never exceed the rated maximum continuous current capacity of the generator.

◆ FREQUENCY METER

This meter indicates the generator's AC output frequency in "Hertz" (cycles per second).

◆ LINE-PHASE SELECTOR SWITCH

This four-position switch permits selection of either line-to-line or line-to-neutral readings on the panel voltmeter and ammeter. Switch positions are as follows:

Switch	Single-phase Units	Three-phase units
1	Line E1 to Neutral	Line E1 to E2
2	Line E3 to Neutral	Line E2 to E3
3	Line E1 to E3	Line E3 to E1
OFF	No Reading	No Reading

Figure 1.6 – E Option Panel Components

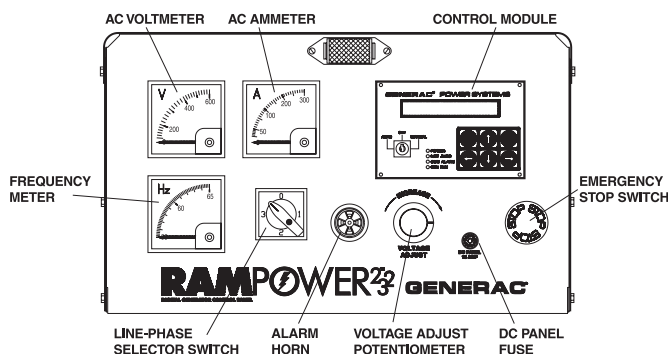

### ◆ VOLTAGE ADJUST POTENTIOMETER

This potentiometer permits the operator to “fine adjust” the generator’s AC output voltage on units rated below 400 kW. Adjustment range is plus or minus five percent. Turn the knob clockwise to increase voltage, counterclockwise to decrease voltage.

### ◆ ALARM HORN

This horn sounds an audible warning when an alarm condition exists. See the “Alarms” section for further information.

### ◆ DC PANEL FUSE

This 15-amp fuse protects the panel components. This fuse is not to be confused with the control module internal fuse discussed in “Checking/Replacing the E Panel Control Module Internal Fuse.”

### ◆ EMERGENCY STOP SWITCH

When pressed, this switch will automatically shut down the entire generator set. The operator must pull the switch out to its original position to reset it and allow for generator operation.

## CHECKING/REPLACING THE E PANEL CONTROL MODULE INTERNAL FUSE

Typically, the main indication of fuse failure is the absence of any illuminated front panel LEDs (even with the key in the OFF position, the “Power” LED will be illuminated) and no text visible on the module display. It should be noted however, that these conditions can exist if either:

- The generator start battery is dead (less than five volts) or disconnected.
- The main panel fuse (15 amp) is blown.
- The battery supply wires (#13 and #0) to the panel control module are open circuit (disconnected).
- The “Power” connector (CON4) is disconnected from the rear of the control module.
- The generator start battery connections have been reversed. Reversal of the battery connections **WILL** blow the internal fuse and is the most likely reason for its failure.

Before removing or disconnecting the E panel control module, check that none of the above conditions (a-e) exist.

#### If you are satisfied that the problem lies with the control module:

- Disconnect the generator start battery.
- Unplug all four wire harnesses from the back of the control module.
- Loosen, then detach, the two retaining clips securing the control module and remove the module.

- Using a multimeter (e.g., Fluke 87) set to the diode range, measure between pins 1 (BAT+) and 2 (BAT-) of connector CON4 on the module.
  - With the **positive** meter lead connected to **pin 2** and the **negative** lead to **pin 1**, the meter should read between 0.4 and 0.6 volts, which indicates that the internal fuse is OK.
  - Reversing the meter leads would give a slowly increasing voltage reading on the meter, which also indicates a good fuse.
  - An open circuit fuse will give an open circuit meter reading (.OL on Fluke 87).

#### If the meter reads open circuit:

- Remove the four phillips head screws retaining the rear cover of the control module.
- Open the back of the control module.
- Locate the internal printed-circuit board mounted fuse, which is behind and to the left of CON4.
- Remove the white plastic cover from the fuse holder and remove the fuse.
- If the fuse has blown, replace the fuse (part #0A5705), reassemble the control module, and reinstall the control module and its connections.
- Reconnect the generator start battery and check if the control module now functions.

If the fuse blows again, or was not blown when the module was opened, or the module still does not function, the E panel control module must be replaced.

## USER PROGRAMMABLE INPUTS

The E panel has eight (8) user programmable inputs. These inputs can be used for annunciation, pre-alarm, or shutdown alarms. Four of the inputs, Battery Charge Fail, Gen Power, Line Power, and Programmable Input 4 are set up to annunciate on the control panel display and at the optional 20 Light Remote Annunciator (Programmable Input 4 will light the unlabeled “spare” LED). These four inputs can be used for other connections if a remote annunciator is not used. The other four inputs, if utilized, will annunciate at the control panel only.

The user programmable input connection points are located inside the E option control panel on a 12-position strip labeled TB3 (refer to Figures 1.7 and 1.8 on page 12.). The first four terminals are labeled “prog input gnd”. These are the common ground connection points for the user supplied switch devices to be used for the programmable annunciation.

#### NOTE:

**These ground terminals are for user programmable input use only. The are not to be used for grounding any other circuits.**

Figure 1.7 — TB3 Units Up to 400 kW

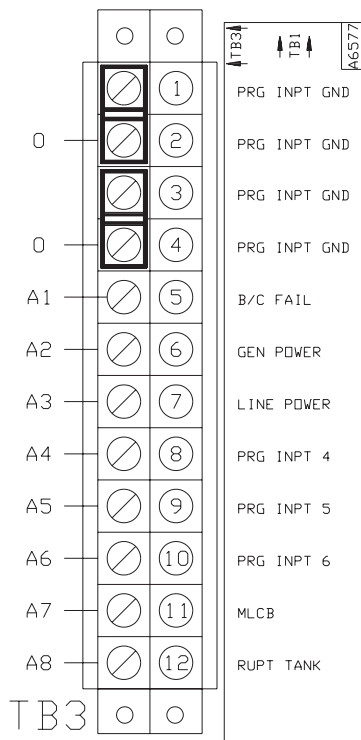
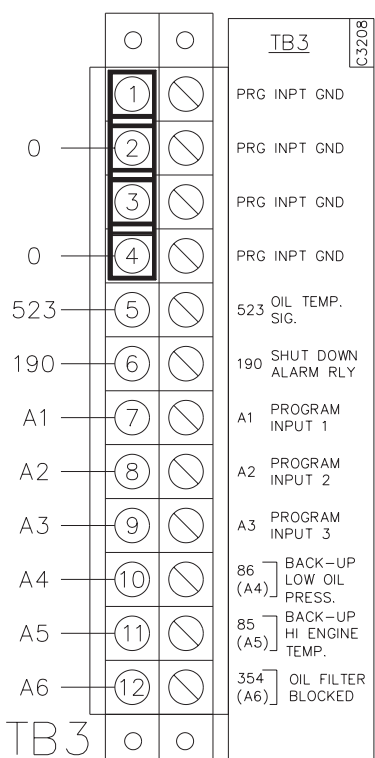

Figure 1.8 — TB3 Units Over 400 kW



The remaining eight terminals on TB3 are for the “positive” side of each user programmable input switch circuit. These eight terminals have a five VDC potential available in an open-circuit condition (whether the control panel key switch is in the off, manual, or auto position). The inputs can be programmed to annunciate upon either an open circuit condition (five VDC potential at the terminal) or a grounded condition (zero VDC potential at the terminal). This voltage state is determined by the user supplied switch either opening or closing to cause an annunciation.

Program set-up for the user programmable inputs is carried out in the Digital I/O Menu of the E module (please refer to the Display Map on pages 18-19). Each of the eight inputs has four parameters in which specific options must be selected to make the annunciation function properly. These four parameters are labeled Input Channel Message, Input Channel Setting, Input Channel Alarm Enable, and Input Channel Alarm Type. Following is a brief description of each:

- Input Channel Message — for selecting letters and numbers to spell out what the display will read upon activation of that specific input.
- Input Channel Setting — for selecting whether annunciation should activate upon that specific circuit opening or closing to ground.
- Input Channel Alarm Enable — for enabling or disabling annunciation function of that specific input. Also, if enabled, for selecting when annunciation will be active. The choices are: Disabled, Always, Immediate and Hold-off. See E Control Panel Definitions on page 38.
- Input Channel Alarm Type — for selecting the type of alarm annunciation and the effect it has on the generators control system. The four choices are: Status, Non-latched, Latched and Shutdown. See E Control Panel Definitions on page 14.

## WIRING EXAMPLES

### ◆ USER PROGRAMMABLE INPUT NUMBER 1

On units rated below 400 kW, input number 1 is programmed for “Battery Charge Fail” annunciation at the control panel display, and the LED on the 20 Light Remote Annunciator (if used). A user supplied AC relay is wired in to be powered up by AC voltage that supplies the unit Battery Charger (see Figure 1.9).

Figure 1.9 — Battery Charge Fail Wiring

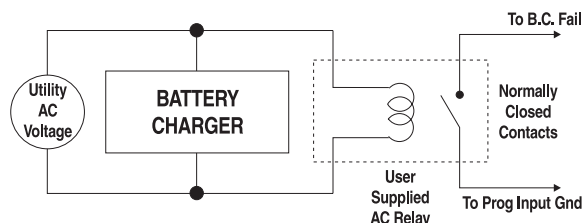

Upon loss of this AC supply voltage, the relay will de-energize. The normally closed contacts on the relay are to be connected to TB3 in the control panel. One wire connects to any of the four “Prog Input Gnd” terminals, the other wire connects to terminal number 5 (B/C Fail). With the relay de-energized, terminal 5 will be grounded, signaling the E module to activate on Programmable Input 1.

### ◆ USER PROGRAMMABLE INPUTS NUMBERS 2 AND 3

On units rated below 400 kW, input numbers 2 and 3 are programmed for “Gen Power” and “Line Power” respectively, indicating the transfer switch position (Standby or Utility). Annunciation will occur at the control panel display and at the Remote Annunciator (if used). These signals will come from a set of spare auxiliary contacts located on the main contactor assembly in the transfer switch. The auxiliary contact switch is a set of dry contacts with three terminals: Common, Normally Open, and Normally Closed. Wires must be connected to these three terminals and routed to the generator control panel. These three wires must not be run in the same conduit as the generator’s main output conductors. The wire connected to the Common terminal on the auxiliary contacts will connect to any of the Prog Input Gnd terminals on TB3. The wire connected to the Normally Open terminal on the auxiliary contacts will connect to terminal 6 (Gen Power) on TB3. The wire connected to the Normally Closed terminal on the auxiliary contacts will connect to terminal 7 (Line Power) on TB3.

### ◆ ALL USER PROGRAMMABLE INPUTS

On units rated below 400 kW, input numbers 4 through 8, and units rated over 400 kW, input numbers 1 through 8 can be used for virtually any kind of annunciation the user wishes to set up, within the parameters previously described, via an opened or closed switch device. Proper wiring consists of two wires from the user supplied switch: one wire connects to one of the “Prg Inpt Gnd” terminals (1 through 4 on TB3), the other wire connects to a Programmable Input terminal on TB3.

## PROGRAMMING EXAMPLES

### ◆ USER PROGRAMMABLE INPUT NUMBER 1

To be used for Battery Charge Fail annunciation. After properly wiring the circuit as described in Wiring Examples, program as follows:

1. Power up the E panel by connecting unit battery (ies) and inserting control panel fuse. The module will run through a self-test mode. Once it has completed its self-test, it will display the generator status (Stopped, ready to run).

2. Use the LEFT or RIGHT arrow keys to scroll over to the PARAMETER ENTRY column.
3. Once at the PARAMETER ENTRY column, press ENTER. Enter the password (if different from the factory set password 000000) and press ENTER. From the ENGINE PARAMETER MENU, press the RIGHT arrow to get to the DIGITAL I/O MENU.
4. Using the UP or DOWN arrows (the column is a continuous loop), scroll to INPUT CHANNEL 1 MESSAGE and press ENTER. Up to 24 letters, numbers and other characters can be entered to spell out what will be displayed upon this input becoming active. In this case, enter Battery Charge Fail. After entering the message, press ENTER.
5. Press the UP arrow to display INPUT CHANNEL 1 SETTING. Press ENTER, the display will read Input Function, OPEN=ALARM. The Battery Charge Fail annunciation should occur upon the user supplied relay de-energizing and its normally-closed contact closing, therefore, select CLOSED=ALARM by pressing the UP or DOWN arrow. Press ENTER, the display will read Input Channel 1 Setting, CLOSED=ALARM.
6. Press the UP arrow, the display will read Input 1 Alarm Enable, DISABLED, press ENTER. The choices are DISABLED, ALWAYS, IMMEDIATE, and HOLD OFF. This alarm should always be active, therefore, scroll up or down and select ALWAYS, and press ENTER.
7. Press the UP arrow, the display will read Input Channel 1 Alarm Type, STATUS MESSAGE, press ENTER. The choices are STATUS MESSAGE, NON LATCHING ALARM, LATCHING ALARM and SHUTDOWN ALARM. This annunciation for Battery Charge Fail should be a STATUS message, therefore, scroll up or down and select STATUS MESSAGE by pressing ENTER.

Programming for User Input Channel 1, Battery Charge Fail is now complete. The E module has been programmed for a STATUS alarm message that is ALWAYS active. Upon loss of AC supply voltage to the generators battery charger, the user supplied relay will de-energize, its normally closed contacts will close, grounding TB3 terminal 5 to Prg Input Gnd. The E module will display BATTERY CHARGE FAIL. Because it was programmed as a STATUS alarm and not a LATCHING or SHUTDOWN alarm, the status message will clear when AC power is restored to the battery charger.

#### NOTE:

**The Battery Charger Fail LED on the 20 Light Remote Annunciator (if connected) will also turn on when Input Channel 1 is activated.**

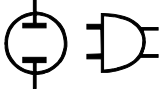

**OUTPUT FUNCTION TABLE**

<b>Output Function ID</b>	<b>Function Name</b>	<b>Description</b>
00	Output Disabled	Output not in use
01	Common Alarm	Active for all latched, non-latched and shutdown alarms
02	Low Oil Pressure Warning	Active after hold off time
03	Oil Pressure Shutdown	Active after hold off time, low oil pressure
04	High Coolant Temp. Warning	Active after hold off time
05	Coolant Temp. Shutdown	Active after hold off time, high coolant temperature
06	Low Coolant Temp. Alarm	
07	High Oil Temp. Warning	
08	Oil Temp. Shutdown	High oil temperature
09	Low Battery Voltage	Must be below set value for five minutes
10	High Battery Voltage	
11	Overspeed Shutdown	
12	Underspeed Alarm	Active after hold off time
13	Over Voltage Alarm	Active after hold off time
14	Under Voltage Alarm	Active after hold off time
15	Over Frequency Alarm	Active after hold off time
16	Under Frequency Alarm	Active after hold off time
17	High Fuel Alarm	Above the warning set-point
18	Low Fuel Alarm	Below the warning set-point
19	Low Fuel & Shutdown	Below the shutdown set-point
20	Failed to Start Alarm	Overcrank
21	Coolant Level Alarm	Low coolant level
22	RPM Sensor Failed Alarm	Magnetic pickup failure
23	Start Inhibit Alarm	Oil pressure was present at start request
24	Emergency Stop Alarm	Emergency stop active
25	Oil Press. Sense Fault	Sensor is either open or short circuit
26	Oil Temp. Sense Fault	Sensor is either open or short circuit
27	Coolant Temp. Sense Fault	Sensor is either open or short circuit
28	Analog Channel 1 High	Input at user analog channel 1 is above programmed high set-point
29	Analog Channel 1 Low	Input at user analog channel 1 is below programmed low set-point
30	Analog Channel 2 High	Input at user analog channel 2 is above programmed high set-point
31	Analog Channel 2 Low	Input at user analog channel 2 is below programmed low set-point
32	Digital Channel 1 Active	User programmable digital input 1 is active
33	Digital Channel 2 Active	User programmable digital input 2 is active
34	Digital Channel 3 Active	User programmable digital input 3 is active
35	Digital Channel 4 Active	User programmable digital input 4 is active
36	Digital Channel 5 Active	User programmable digital input 5 is active
37	Digital Channel 6 Active	User programmable digital input 6 is active
38	Digital Channel 7 Active	User programmable digital input 7 is active
39	Digital Channel 8 Active	User programmable digital input 8 is active
40	Generator in Auto	Key switch in auto position
41	Generator in Manual	Key switch in manual position
42	Generator Off	Key switch in off position
43	Stopped	Generator stopped
44	Shutdown Due to Alarm	Generator shutdown
45	Stopped Ready to Run	Generator ready to start
46	Running	Generator running
47	Ready to Accept Load	Generator has reached load accept voltage and frequency set-points, and the warm-up timer has expired
48	All Alarms Active	Generator running

## E PANEL MASTER CONTROL BOX CONFIGURATION SETTINGS

### ENGINE PARAMETER MENU

Parameter	Value	Units
RS232 Port or RS485 Port	Connection Mode (C1)	
Restore All Values to Default Settings	Direct Connection Only	
Voltage Scaling Factor	Master Password Required (Factory Only)	
Flywheel Teeth	.05 to 300	Number
Panel I.D.	30 to 200	
User Password	000000 to 999999	
Preheat Option	000000 to 999999 (P1)	
Load Accept Frequency	0 to 90	Hz
Load Accept Voltage	0 to 2000	V
Starter Disengage Speed	0 to 4000	RPM
Number of Start Attempts	0 to 10	Number
Generator Cool Down Time	0 to 600	min.
Generator Warm Up Time	0 to 600	sec.
Alarm Hold Off Time	0 to 15	sec.
Start Attempt Pause Time	5 to 600	sec.
Start Timer	3 to 15	sec.
Preheat Timer	0 to 30	sec.

**Available Options:** P1 = No Preheat, Before Start, Before and During Start  
C1 = Direct Connection, Modem Connection, Modem Connection & Setup

### SYSTEM ALARM MENU

Parameter	Value	Units	Active	Type
Low Fuel Shutdown Alarm	0 to 100	%	(A2)	Shutdown Alarm
Fuel Level Low Warning	0 to 100	%	(A2)	Non-latching Alarm
Fuel Level High Warning	0 to 100	%	(A2)	Non-latching Alarm
Under Freq.	0 to 100	Hz	Hold Off	(T1)
Over Freq.	0 to 100	Hz	Hold Off	(T1)
Under Voltage	0 to 2000	V	Hold Off	(T1)
Over Voltage	0 to 2000	V	Hold Off	(T1)
Engine Underspeed Alarm	0 to 4500	RPM	Hold Off	(T1)
Engine Overspeed Alarm	1000 to 4500	RPM	Immediate	Shutdown Alarm
Battery Volts High Warning	4 to 30	V	Always	Non-latching Alarm
Battery Volts Low Warning	4 to 30	V	Always	Non-latching Alarm
Oil Temp. Shutdown Alarm	-5 to 275	Deg. F	(A1)	Shutdown Alarm
Oil Temp. Warning	-5 to 275	Deg. F	(A1)	Non-latching Alarm
Coolant Temp. Shutdown Alarm	-5 to 275	Deg. F	Hold Off	Shutdown Alarm
Coolant Temp. High Warning	-5 to 275	Deg. F	Hold Off	Non-latching Alarm
Coolant Temp. Low Warning	0 to 245	Deg. F	Always	Non-latching Alarm
Oil Press. Shutdown Alarm	0 to 100	PSI	Hold Off	Shutdown Alarm
Oil Press. Warning	0 to 100	PSI	Hold Off	Non-latching Alarm

**Available Options:** A1 = Disable, Hold off, Immediate  
A2 = Disable, Always  
T1 = Shutdown Alarm, Latching Alarm, Non-latching Alarm, Status Message

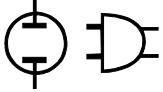

**DIGITAL I/O MENU**

Channel		Message	Setting	Alarm Enable	Alarm Type
Output 1			(F1)		
Output 2			(F1)		
Output 3			(F1)		
Preheat Output Function			(F1)		
User Input 1	*1	Battery Charge Fail	(S1)	(A1)	(T1)
User Input 2	*1	Generator Power	(S1)	(A1)	(T1)
User Input 3	*1	Line Power	(S1)	(A1)	(T1)
User Input 4	*2	Backup Low Oil Pressure	(S1)	(A1)	(T1)
User Input 5	*2	Backup High Engine Temp.	(S1)	(A1)	(T1)
User Input 6	*2	Oil Filter Blocked	(S1)	(A1)	(T1)
User Input 7	*2	MLCB	(S1)	(A1)	(T1)
User Input 8	*2	Ruptured Tank	(S1)	(A1)	(T1)

Messages can be a maximum of 24 characters including spaces.

**Available Options:** A1 = Disabled, Hold Off, Immediate, Always  
 F1 = See output function table for available options.  
 S1 = Closed (Low Signal/Contact Closure to Ground), Open (High signal/Open Circuit)  
 T1 = Shutdown Alarm, Latching Alarm, Non-latching alarm, Status Message

\*1 Assigned if used with 20 light Remote Annunciator or Remote Relay Panel Otherwise available for any customer options.

\*2 Factory wired if unit is equipped with these options. Otherwise these inputs are available for any customer requirements.

**ANALOG INPUT MENU**

	Value at 0V	Value at 10V	(Display) Title	Alarm Msg. Message		Setpoint		(Alarm) Enable		(Alarm) Type	
				High	Low	High	Low	High	Low	High	Low
Analog Channel 1								(A1)	(A1)	(T1)	(T1)
Analog Channel 1								(A1)	(A1)	(T1)	(T1)

Messages can be a maximum of 24 characters including spaces.

**Available Options:** A1 = Disabled, Hold Off, Immediate, Always  
 T1 = Shutdown Alarm, Latching Alarm, Non-latching alarm, Status Message

Section 2 – Operation  
E Option Control Panels  
GenLink® Communications Flowchart

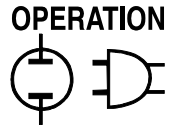

TABLE A

Dip Switch	Setting
1	Up
2	Down
3	Down
4	Down
5	Up
6	Up
7	Up
8	Down

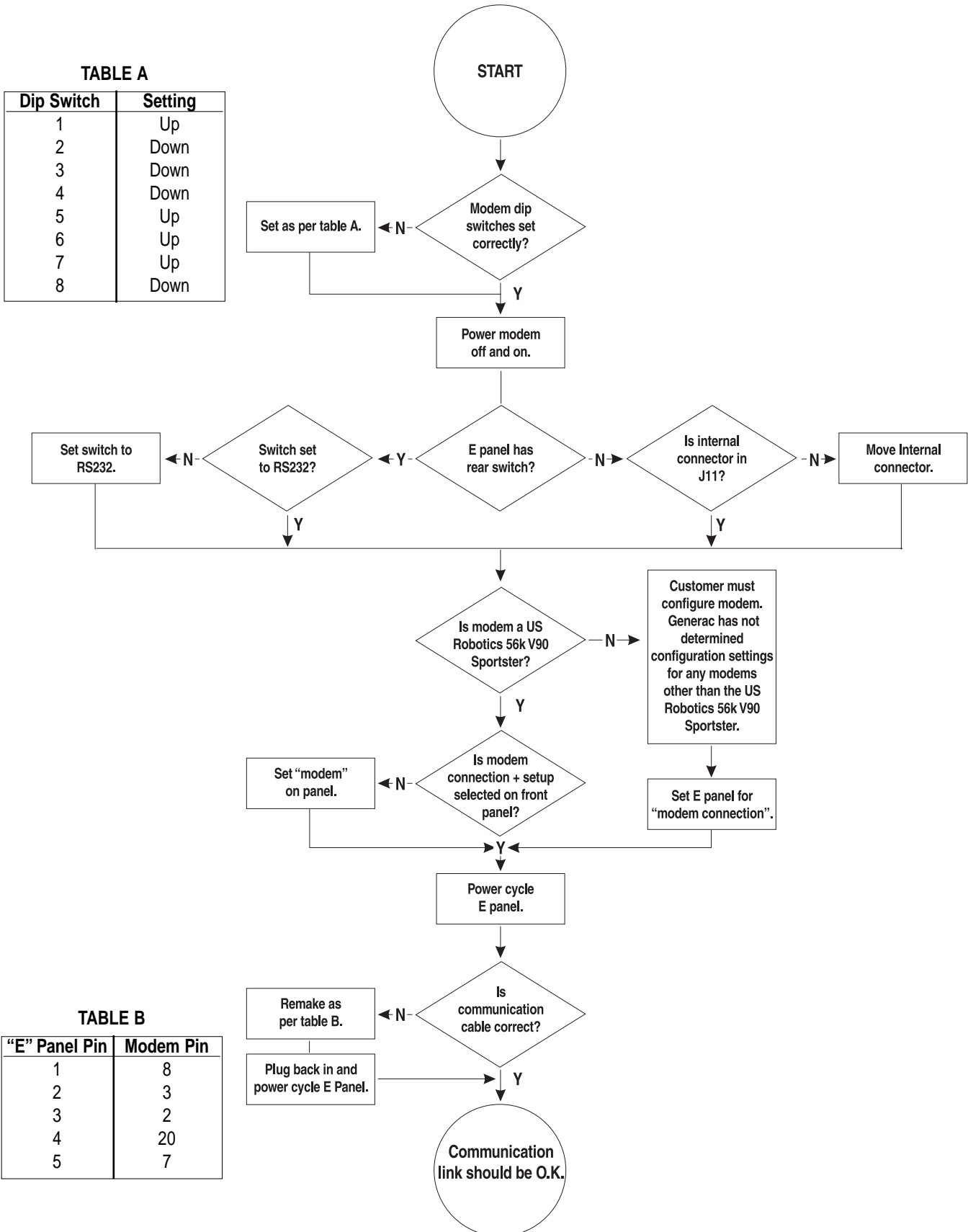

TABLE B

"E" Panel Pin	Modem Pin
1	8
2	3
3	2
4	20
5	7







## OIL PRESSURE SENSING (Refer to Figure 3.1)

### ◆ OVERVIEW

An analog Oil Pressure Sender (OPS) is used for monitoring the engine oil pressure. This sender allows the E panel to measure and display the Engine oil pressure.

Refer to the owners manual for the OPS part number and mounting location.

Wire number 69 is used to connect the OPS to the E Panel. The Ground for the OPS is made through the engine block.

The OPS is a resistive device, whose resistance changes based on engine oil pressure. The resistance of the sender results in a voltage being developed across the sender. As the oil pressure increases, the resistance will decrease, causing the voltage to decrease. This changing voltage is read by the E Panel and converted into the engine Oil Pressure.

The E Panel will monitor and display oil pressure anytime the DC input to the E Panel is present.

### ◆ TROUBLESHOOTING

Prior to any troubleshooting, the oil pressure parameters programmed into the E Panel should be checked and verified. The oil pressure input has two different set points associated with it. They are:

**Pre-Low Oil Pressure Warning:** This is the warning set point. The generator's alarm will sound, but the generator will continue to run.

**Critical Low Oil Pressure Alarm:** This is the alarm set point. The generator will shut down and sound the alarm.

It is important to verify that these parameters are set correctly for the specific unit. Check the E Panel settings against the Generator setup sheet. If the generator setup sheet is not available, contact Generac's service department for the recommended settings.

**Figure 3.1 — Oil Pressure Sender Connections**

Oil Pressure Sender Connections  
Refer to the unit's Wiring Diagram for specific connector locations

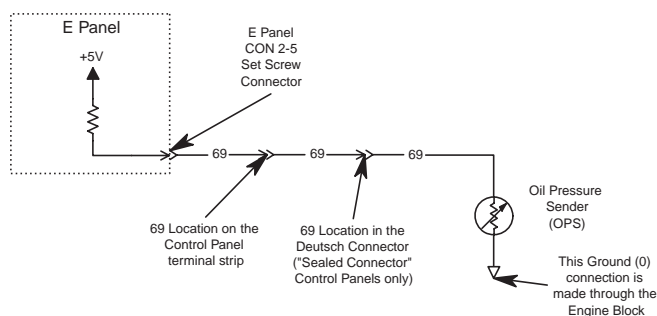

### ◆ TESTING THE CONTROL PANEL

It is relatively easy to do a thorough test of the E Panel's Oil Pressure input.

Place the Auto/Off/Manual switch to the Off position during this testing.

#### ◇ Open circuit testing

This test checks the high end of the oil pressure input of the E Panel.

1. Remove the 69 wire from the control panel terminal strip. This simulates a sender open circuit condition.
2. Look for the following response from the E Panel: The back light will flash, the Com Alarm LED will flash, and the display will read as follows:

**OIL PRESS SENSE FAULT  
PRESS ENTER TO ACCEPT**

3. Press enter to accept the alarm.

#### ◇ Short circuit testing

This test checks the low end of the oil pressure input of the E Panel.

1. Reconnect the 69 wire to the control panel terminal strip.  
Connect a jumper wire between the 69 and 0 positions on the control panel terminal strip. This simulates a sender short circuit condition
2. Look for the following response from the E Panel
  - 2.1 For units with software version V1.11 and earlier: The back light will flash, the Com Alarm LED will flash, and the display will read as follows:

**OIL PRESS SENSE FAULT  
PRESS ENTER TO ACCEPT**

Press enter to accept the alarm.

- 2.2 For units with software version V1.12 and later:  
Use the arrow keys to go to the Oil pressure display screen.  
The screen should display oil pressure as 125 p.s.i.

#### ◇ Control panel testing complete

1. Remove the jumper between the 69 and 0 locations on the control panel terminal strip.
2. If any E Panel alarms are present, press enter to accept.

#### ◇ Test Results

1. Tests 1 and 2 Pass:

Move on to the next test "Testing the Oil Pressure Sender".



2. If either test 1 or 2 failed:
  - 2.1 Repeat the open and short circuit testing directly at the back of the E Panel as follows:

**Open:** The 69 wire should be removed from CON2-5

**Short:** With the 69 wire still removed, insert a jumper wire into CON2-5. Connect the other end of the jumper to ground (0).

After testing, remove the jumper wire from CON2-5 and insert the 69 wire back into CON2-5
  - 2.2 Test results:
    - 2.2.1 If these tests fail again directly at the back of the E Panel, then the E Panel has failed and should be replaced.
    - 2.2.2 If these tests pass at the back of the E Panel, but failed at the terminal strip, then there is a wiring error between the E Panel and the terminal strip. Check this wiring carefully.

#### ◆ TESTING THE OIL PRESSURE SENDER

The resistance of the OPS can be checked in a power down state as follows:

1. Remove the control panel fuse to power down the E panel.
2. Unplug CON2 from the E Panel.
3. Measure the resistance of the oil pressure sender. This measurement should be made between the sender terminal and the sender body.

The sender resistance should measure between 225 and 260 Ohms at 0 PSI.

#### NOTE:

**If the engine has just been stopped, allow sufficient time for the oil pressure to drop to zero before making this measurement.**

If the resistance measurement is not in this range, the sender has failed. Replace the sender.

If the resistance measurement is in this range, move on to the next test.

#### ◆ TESTING THE OIL PRESSURE SENDER CONNECTIONS

##### ✧ Visual Inspection

Carefully check the wiring between the oil pressure sender and the E Panel.

1. Check the 69 wire connection to the OPS.
  - 1.1 Check for a proper crimp on the lug.

- 1.2 Check to see if the sender nut is tightened securely. Be careful not to over tighten the nut. If the nut is over tightened, the stud will break free and cause incorrect sender readings. This nut should be tightened to 14 to 18 inch pounds.
- 1.3 Check for any environmental corrosion on the lug or the sender terminal. Generac recommends the following actions if corrosion is found:
  - 1.3.1 Replace the lug.
  - 1.3.2 Replace the sender if possible. If not possible, thoroughly remove all of the corrosion from the sender terminal.
  - 1.3.3 Protect the lug and sender terminal with an approved automotive dielectric grease.
2. Check the 69 wire in the Deutsch connector (only used on the "water tight connector" panels.)
  - 2.1 Refer to appendix A for information on the Deutsch connectors used.
  - 2.2 Refer to the unit's wire diagram for the 69 location in the Deutsch plug.
3. Check the 69 wire on the control panel terminal strip.
  - 3.1 Check for a proper crimp on both lugs.
  - 3.2 Check to see if both screws are tightened securely. These screws should be tightened to 12 inch pounds.
4. Check the 69 wire going into CON2 on the back of the E Panel.
  - 4.1 Check to see if the wire is stripped properly inside the green plug. The wire conductor should be trapped inside the metal wire clamp. The wire insulation should not be trapped inside the metal wire clamp.
  - 4.2 Check to see if the set screw is tightened securely, but do not over tighten. This screw should be set to 2 to 4 inch pounds.
5. Check for any wire damage along the entire run between the E Panel and the sender.
  - 5.1 Check for any areas along the wire with missing insulation. This could allow the 69 line to momentarily come into contact with ground causing a false shut down.
  - 5.2 Check to see if the wire is pinched anywhere along the run. A wire that is pinched between the sheet metal can cause the 69 wire to momentarily come into contact with ground resulting in a shut down fault. A pinched wire may also cause the wire to break inside the insulation. This could cause the 69 line to monetarily "open" while running. This will also result in a shut down fault.



### ✧ Check the OPS mounting

The ground return (0) connection for the OPS is made by the physical connection of the sender to the engine block. This connection may be made directly, or through a series of adapters or fittings.

Check for the following at each junction point:

1. Check for a tight mechanical connection.
2. Check for a good electrical connection.

### ✧ Resistance measurement

The resistance of the OPS was measured in "Testing the Oil Pressure Sender."

In that test, the resistance was measured directly across the OPS. This test will now measure that same resistance inside the control panel. This will provide an additional test of the wiring and connections used to connect the sender to the control panel.

1. Remove the control panel fuse to power down the E Panel.
2. Unplug CON2 from the E Panel.
3. Measure the resistance between the 69 and 0 locations on the control panel terminal strip.
4. Compare this measurement to the measurement taken directly across the OPS.
  - 4.1 If this measurement is more than 2-3 Ohms greater than the one taken directly across the OPS, there is a problem with the sender connections. You can determine if the problem is the 69 connection or the 0 connection as follows:
    - 4.1.1 Measure the resistance between the OPS stud and the 69 wire inside the control panel. If this measurement is greater than 2-3 Ohms, replace the entire wire running between the control panel and the OPS stud.
 

Repeat step D, measuring the resistance between the 69 and 0 locations on the control panel terminal strip and comparing it to the earlier reading.
    - 4.1.2 Measure the resistance between the body of the sender and the 0 location on the control panel terminal strip. If this measurement is greater than 2-3 Ohms, go back and carefully check the following:
      - 4.1.2.1 OPS mounting, including all fittings and adapters.
      - 4.1.2.2 Remove the OPS and check the conditions of the threads. Check for an excessive amount of pipe sealant on the threads. Ensure there is no pipe sealant on the end of the sender covering the oil inlet hole. Repeat step D, measuring the resistance between the 69 and 0 locations on the control panel terminal strip and comparing it to the earlier reading.
      - 4.2 If this measurement is less than 2-3 Ohms greater than the one taken directly across the OPS, and a thorough visual inspection was performed, the wiring is OK.

## LOW COOLANT LEVEL (Refer to Figure 3.2)

### ◆ OVERVIEW

A Low Coolant Level (LCL) sensor is placed in the generator's coolant system. This sensor allows the E Panel to detect a Low Coolant Level condition.

Wire number 85 is used to connect the LCL to the E Panel. The Ground for the LCL is made through the radiator frame or engine block (depending on where the LCL is located). The LCL is a resistive device whose resistance changes based on the temperature of the LCL.

The resistance of the LCL results in a voltage being developed across the LCL. This voltage changes as the resistance changes. This changing voltage is read by the E Panel.

The LCL is supplied with current from the E Panel. This current will cause the LCL to generate heat. If the LCL is in coolant, the coolant will keep the LCL from heating up. If the LCL is in air, it will heat up telling the E panel there is a low coolant condition.

In most systems, a back up High Water Temperature (HWT) switch is wired in parallel with the LCL. This switch is a normally open switch whose contacts will close at a predetermined temperature setting. If this HWT switch closes, it will result in the E Panel shutting down with a "Low Coolant Level" display.

Refer to owners manual for the LCL and HWT part numbers and mounting locations.

The E Panel checks for low coolant level as follows:

**Software version V1.03 and earlier:** Will check for a low coolant level anytime the DC input to the E Panel is present.

**Software version V1.04 and later:** Will only check for a low coolant level once the engine has started and the hold off timer has expired.

There are no user-definable parameters for the Low Coolant Level.



## ◆ TROUBLESHOOTING

Figure 3.2 — Water Level Sensor Connections

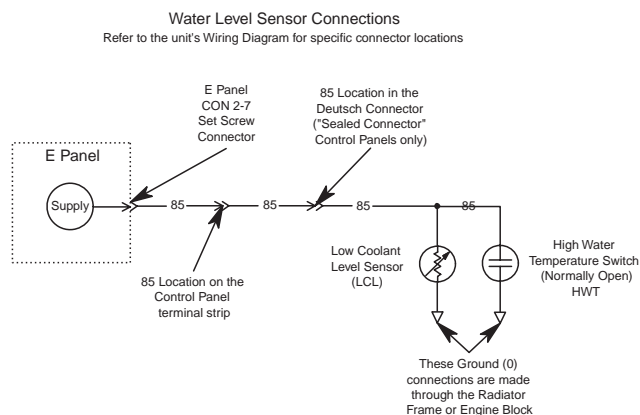

## ◆ TESTING THE CONTROL PANEL

It is relatively easy to do a thorough test of the E Panel's Low Coolant Level input.

In most cases it is necessary to run the engine while doing this testing.



⚠ **Once the engine has started, there will be high voltage inside the generator's control panel and at CON4 of the E Panel.**

### ◇ Open circuit testing

This test checks the high end of the low coolant level input.

1. With the generator stopped, remove the 85 wire from the control panel terminal strip. This simulates a sender open circuit condition.
2. Start the Generator.
  - 2.1 The generator should not shut down on Low Coolant Level with the 85 wire disconnected. If the generator does shutdown on low coolant level, there is a fault with the E Panel.
  - 2.2 With the 85 wire still disconnected, use a DC volt meter to measure the voltage between the 85 wire (the end still connected to the E Panel) and ground. This voltage should be 10 volts DC or greater. If this voltage is below 10 volts DC, there is a fault with the E Panel. Replace the E Panel.
  - 2.3 Stop the generator.

### ◇ Short circuit testing

This test checks the low end of the low coolant level input.

1. Reconnect the 85 wire to the control panel terminal strip. Connect a jumper wire between the 85 and 0 locations on the control panel terminal strip. This simulates the HWT switch closing to ground.
2. The E panel should respond as follows:
  - 2.1 E Panels with V1.03 and earlier software:  
The E Panel will sound the alarm and display a low coolant level fault.
  - 2.2 E Panels with V1.04 and later software: Start the generator and observe the following:
    - 2.2.1 The E Panel should start normally.
    - 2.2.2 Once the engine has started, the hold off timer will start.
    - 2.2.3 Once the hold off timer expires, the E Panel will shut the engine down and display a low coolant alarm.

### ◇ Control panel testing complete

1. Shut down the generator engine.
2. Remove the jumper between the 85 and 0 locations.

### ◇ Test Results

1. Tests 1 and 2 Pass:  
Move on to the next test "Checking the wiring between the E Panel and the LCL/HWT".
2. If either test 1 or 2 failed:
  - 2.1 Repeat the open and short circuit testing directly at the back of the E Panel as follows:
 

**Open:** The 85 wire should be removed from CON2-7.

**Short:** With the 85 wire still removed, insert a jumper wire into CON2-7. Connect the other end of the jumper to ground (0).

After testing, remove the jumper wire from CON2-7 and insert the 85 wire back into CON2-7.
  - 2.2 Test results:
    - 2.2.1 If these tests fail again directly at the back of the E Panel, then the E Panel has failed and needs to be replaced.
    - 2.2.2 If these tests pass at the back of the E Panel, but failed at the terminal strip, then there is a wiring error between the E Panel and the terminal strip. Check this wiring carefully.



### ◆ CHECK THE WIRING BETWEEN THE E PANEL AND THE LCL/HWT

The Low coolant level input is active low. This means that a short to ground on the 85 line will cause the E Panel to shut down for Low coolant level.

Very carefully check the 85 wire from the back of the E Panel out to the LCL and HWT. Check for the following:

1. Check for any areas along the wire with missing insulation. This could allow the 85 line to momentarily come into contact with ground causing a shut down.
2. Check to see if the wire is pinched anywhere along the run. A wire that is pinched against sheet metal can cause the 85 wire to momentarily come into contact with ground resulting in a shut down.  
A pinched wire may also cause the wire to break inside the insulation. This could cause the 85 line to momentarily "open" while running. This "open" condition would not result in a false shutdown, but it could prevent the E Panel from shutting down the generator in the event of a true failure.
3. Check the 85 wire connection to the LCL
  - 3.1. Check for a proper crimp on the lug.
  - 3.2 Check for any environmental corrosion on the lug or the switch terminal. Generac recommends the following actions if corrosion is found:
    - 3.2.1 Replace the lug.
    - 3.2.2 Replace the sender if possible. If not possible, thoroughly remove all of the corrosion from the sender terminal.
    - 3.3.3 Protect the lug and sender terminal with an approved automotive dielectric grease.
4. Check the 85 wire connection to the HWT switch.
  - 4.1 Check for a proper crimp on the lug.
  - 4.2 Check for any environmental corrosion on the lug or the switch terminal. We recommend the following actions if corrosion is found:
    - 4.2.1 Replace the lug.
    - 4.2.2 Replace the switch if possible. If not possible, thoroughly remove all of the corrosion from the sender terminal.
    - 4.2.3 Protect the lug and switch terminal with an approved automotive dielectric grease.
5. Check the 85 wire in the Deutsch connector (only used on "water tight connector" panels.)
  - 5.1 Refer appendix A for information on the Deutsch connectors used.
  - 5.2 Refer to the unit's wiring diagram for the specific wire location.

6. Check the 85 wire on the control panel terminal strip.
  - 6.1 Check for a proper crimp on both lugs.
  - 6.2 Check to see that both screws are tightened securely. These screws should be tightened to 12 inch pounds.
7. Check the 85 wire going into CON2 on the back of the E Panel.
  - 7.1 Check to see the wire is stripped correctly. The wire conductor should be trapped inside the metal wire clamp. The wire insulation should not be inside the metal wire clamp.
  - 7.2 Check to see if the set screw is tightened securely. This screw should be set to 2 to 4 inch pounds.
8. Check the LCL and the HWT mounting. The ground return (0) connection for these devices is made by the physical connection of the device body to the engine block/radiator frame. These connections can be made directly or through a series of adapters or fittings. Check for a good mechanical and electrical connection at each junction point.

### ◆ TESTING THE LCL/HWT

1. Check the devices while the generator is not running.
  - 1.1 Test the resistance of the LCL.
    - 1.1.1 Remove the front panel fuse to power down the E Panel.
    - 1.1.2 Unplug CON2 from the E Panel.
    - 1.1.3 Disconnect the 85 wire from the LCL.
    - 1.1.4 Measure the resistance of the LCL. This measurement should be taken from the sender terminal to the sender body. The sender should measure between 40 and 65 ohms. This resistance will vary with temperature. It will be closer to 40 ohms at 30F, and closer to 65 ohms at 120F.  
If the resistance measurement is not in this range, the sender has failed and needs to be replaced.
    - 1.1.5 Reconnect the 85 wire to the LCL.
  - 1.2 Test the HWT switch.
    - 1.2.1 Disconnect the 85 wire from the HWT switch.
    - 1.2.2 Measure the resistance of the HWT switch. This resistance should be taken from the switch terminal to the switch body.
    - 1.2.3 This resistance should measure "infinity" or "open circuit". If not, the switch has failed and needs to be replaced.
    - 1.2.4 Reconnect the 85 wire to the HWT switch. Plug CON2 back into the E Panel. Replace the front panel fuse.



2. Check the devices while the generator is running. If the E Panel is still shutting down on low coolant level, and both devices check good in the power down state, the devices can be checked while the engine is running. The following tests will isolate the two different senders and determine which sender is causing the shutdown.

**NOTE:**

**It is very important that the wiring between the E Panel and the LCL/HWT was carefully checked as described above. Incorrect wiring or damage to any of the wiring can result in false test results.**

- 2.1 Test the HWT switch.
  - 2.1.1 Disconnect the 85 wire connected to the LCL. Position the wire such that the lug will not come into contact with any metal surface.
  - 2.1.2 Start and run the generator. If the generator shuts down with a low coolant level alarm, the HWT switch is the cause. Replace the HWT switch.  
If the generator does not shut down on alarm, stop the generator and proceed to the next test.
- 2.2 Test the LCL sender.
  - 2.2.1 Reconnect the 85 wire to the LCL.
  - 2.2.2 Disconnect the 85 wire connected to the HWT switch. Position the wire such that the lug will not come into contact with any metal surface.
  - 2.2.3 Start and run the generator. If the generator shuts down with a low coolant level alarm, the LCL is the cause. Replace the LCL.  
If the generator does not shut down on alarm, stop the generator manually.
  - 2.2.4 Reconnect the 85 wire to the HWT.

The WTS is a resistive device whose resistance changes based on coolant temperature. The resistance of the sender results in a voltage being developed across the sender. As the Coolant temperature increases, the resistance will decrease, causing the voltage to decrease. This changing voltage is read by the E Panel and converted into coolant temperature.

The E Panel will monitor and display the coolant temperature anytime the DC input to the E Panel is present.

◆ **TROUBLESHOOTING**

Prior to any troubleshooting, the Coolant Temperature parameters programmed into the E Panel should be checked and verified. The coolant temperature has three different set points associated with it. They are:

- **Low Coolant Temp Warning:** This is a warning set point. The generator's alarm will sound, but the unit will continue to run.
- **Pre-High Coolant Temp Warning:** This is a warning set point. The generator's alarm will sound, but the unit will continue to run.
- **High Coolant Temp Alarm:** This is the alarm set point. The generator will shut down and sound the alarm.

It is important to verify that these parameters are set correctly for the specific unit. Check the E Panel settings against the generator setup sheet. If the generator setup sheet is not available, contact Generac's service department for the recommended settings.

**Figure 3.3 — Water Temperature Sender Connections**

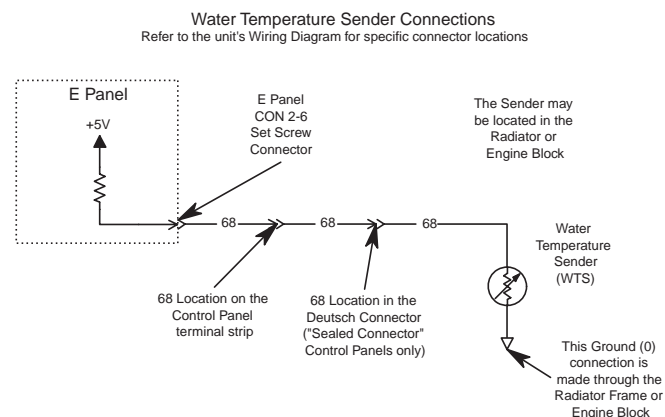

**COOLANT TEMPERATURE SENSING**

(Refer to Figure 3.3)

◆ **OVERVIEW**

An analog Water Temperature Sender (WTS) is located in the engine's cooling system. This sender is connected to the E Panel and allows the E Panel to monitor and display the temperature of the Coolant system. Wire number 68 is used to connect the WTS to the E Panel. The ground for the WTS is made through the radiator frame or engine block (depending on where the WTS is located).

Refer to the owners manual for the WTS part number and mounting location.

◆ **TESTING THE CONTROL PANEL**

It is relatively easy to do a thorough test of the E Panel's Coolant Temperature input.

Place the Auto/Off/Manual switch to the Off position during this testing.



### ❖ Open circuit testing

This test checks the high end of the coolant temperature input of the E Panel.

1. Remove the 68 wire from the control panel terminal strip. This simulates a sender open circuit condition.
2. Look for the following response from the E Panel. The E Panel should respond in either one of the following ways:
  - 2.1 The Coolant temperature display will read less than 20 F.

**OR**

- 2.2 The back light will flash, the com alarm LED will flash, and the display will read as follows:

**OIL TEMP SENSE FAULT  
PRESS ENTER TO ACCEPT**

### ❖ Short circuit testing

This test checks the low end of the coolant temperature input of the E Panel.

1. If any E Panel alarms are present, press enter to accept.
2. Reconnect the 68 wire to the control panel terminal strip.
3. Connect a jumper wire between the 68 and 0 positions on the control panel terminal strip. This simulates a sender short circuit condition.
4. Look for the following response from the E Panel. The back light will flash, the Com Alarm LED will flash, and the display will read as follows:

**COOLANT TEMP SENSE FAULT  
PRESS ENTER TO ACCEPT**

Press enter to accept the alarm.

### ❖ Control panel testing complete

1. Remove the jumper between the 68 and 0 locations.
2. If any E Panel alarms are present, press enter to accept.

### ❖ Test Results

1. Tests 1 and 2 pass:  
Move on to the next test "Testing the coolant temperature sender connections".
2. If either Test 1 or 2 failed:
  - 2.1 Repeat the open and short circuit testing at the back of the E Panel as follows:
    - Open:** The 68 wire should be removed from CON2-6.
    - Short:** With the 68 wire still removed, insert a jumper wire into CON2-6. Connect the other end of the jumper to ground (0).

After testing, remove the jumper wire from CON2-6 and insert the 68 wire back into CON2-6.

#### 2.2 Test results:

- 2.2.1 If these tests fail again directly at the back of the E Panel, then the E Panel has failed and should be replaced.
- 2.2.2 If these test pass at the back of the E Panel, but failed at the terminal strip, then there is a wiring error between the E Panel and the terminal strip. Check this wiring carefully.

## ◆ TESTING THE COOLANT TEMPERATURE SENDER CONNECTIONS

### ❖ Visual Inspection

Carefully check the wiring between the coolant temperature sender and the E Panel.

1. Check the 68 wire connection to the WTS.
  - 1.1 Check for a proper crimp on the lug.
  - 1.2 Check to see if the sender nut it tightened securely. Be careful not to over tighten the nut. If the nut is over tightened the stud will break free and cause incorrect sender readings. This nut should be tightened to 6 to 7 inch pounds.
  - 1.3 Check for any environmental corrosion on the lug or sender terminal. Generac recommends the following actions if corrosion is found:
    - 1.3.1 Replace the lug.
    - 1.3.2 Replace the sender if possible. If not possible, thoroughly remove all of the corrosion from the sender terminal.
    - 1.3.3 Protect the lug and sender terminal with an approved automotive dielectric grease.
2. Check the 68 wire in the Deutsch connector (only used on the "water tight connector" panels.)
  - 2.1 Refer to appendix A for information on the Deutsch connectors used.
  - 2.2 Refer to the units wiring diagram for the 68 location in the Deutsch plug.
3. Check the 68 wire on the control panel terminal strip.
  - 3.1 Check for a proper crimp on both lugs.
  - 3.2 Check to see if both screws are tightened securely. These screws should be tightened to 12 inch pounds.
4. Check the 68 wire going into CON2 on the back of the E Panel.
  - 4.1 Check to see if the wire is stripped properly inside the green plug. The wire conductor should be trapped inside the metal wire clamp. The wire insulation should not be trapped inside the metal wire clamp.



- 4.2 Check to see if the set screw is tightened securely, but do not over tighten. This screw should be set to 2 to 4 inch pounds.
5. Check for any wire damage along the entire run between the E Panel and the sender.
  - 5.1 Check for any areas along the wire with missing insulation. This could allow the 68 line to momentarily come into contact with ground causing a false shut down.
  - 5.2 Check to see if the wire is pinched anywhere along the run. A wire that is pinched between the sheet metal can cause the 68 wire to momentarily come into contact with ground causing a false shut down. A pinched wire may also cause the wire to break inside the insulation, this could cause the 68 line to momentarily "open" while running. This will also result in a false shut down.

### ✧ Check the WTS mounting

The ground return (0) connection for the WTS is made by the physical connection of the sender to the engine block. This connection may be made directly, or through a series of adapters or fittings.

Check for the following at each junction point:

1. Check for a tight mechanical connection.
2. Check for a good electrical connection.

### ✧ Resistance measurements

Power down the E Panel by removing the front panel fuse.

Remove CON2 from the back of the E Panel.

1. Measure the resistance between the WTS stud and the 68 wire inside the control panel. If this measurement is greater than 2-3 Ohms, replace the entire wire running between the control panel and the WTS stud.
2. Measure the resistance between the body of the sender and the 0 location on the control panel terminal strip. If this measurement is greater than 2 -3 Ohms, go back and carefully check the WTS mounting and the star ground connections on the engine block.

## OIL TEMPERATURE SENSING

(Refer to Figure 3.4)

### ◆ OVERVIEW

Oil Temperature sensing is an OPTION offered with the E Panel. When ordered, an analog Oil Temperature Sender (OTS) is mounted in the oil pan. This sender is connected to the E Panel and allows the E Panel to monitor and display the temperature of the engine oil. Wire number 523 is used to connect the OTS to the E Panel. The ground for the OTS is made through the oil pan/engine block.

The OTS is a resistive device, whose resistance changes based on oil temperature. The resistance of the sender results in a voltage being developed across the sender. As the oil temperature increases, the resistance will decrease, causing the voltage to decrease. This changing voltage is read by the E Panel and converted to oil temperature.

### ◆ TROUBLESHOOTING

Prior to any troubleshooting, verify the following:

1. Verify the oil temperature option has been ordered and installed on the generator.
2. Check and verify the Oil Temperature parameters programmed into the E Panel. The oil temperature has two different set points associated with it.

**Pre-High Oil Temp Warning:** This is a warning set point. The generator's alarm will sound but the generator will continue to run. This parameter should be Disabled if no sender was fitted.

**High Oil Temp Alarm:** This is an alarm set point. The generator will shut down and sound the alarm. This parameter should be Disabled if no sender was fitted.

It is important to verify that these parameters are set correctly for the specific unit. Check the E Panel settings against the Generator setup sheet. If the generator setup sheet is not available, contact Generac's service department for the recommended settings.

**Figure 3.4 — Optional Oil Temperature Sender Connections**

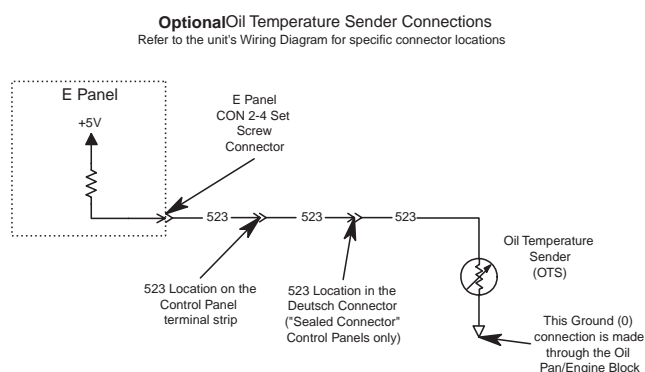

### ◆ TESTING THE CONTROL PANEL

It is relatively easy to do a thorough test of the E Panel's Oil Temperature input.

Place the Auto/Off/Manual switch to the Off position during this testing.



### ❖ Open circuit testing

This test checks the high end of the oil Temperature input of the E Panel.

1. Remove the 523 wire from the control panel terminal strip. This simulates a sender open circuit condition.
2. The E Panel should respond in either one of the following ways:
  - 2.1 The Coolant temperature display will read less than 20 F.

**OR**

- 2.2 The back light will flash, the com alarm LED will flash, and the display will read as follows:

**OIL TEMP SENSE FAULT  
PRESS ENTER TO ACCEPT**

### ❖ Short circuit testing

This test checks the low end of the oil temperature input of the E Panel.

1. Reconnect the 523 wire to the control panel terminal strip.
2. Connect a jumper wire between the 523 and 0 locations on the control panel terminal strip. This simulates a sender short circuit condition.
3. Look for the following response from the E Panel. The back light will flash, the Com Alarm LED will flash, and the display will read as follows:

**OIL TEMP SENSE FAULT  
PRESS ENTER TO ACCEPT**

Press enter to accept the alarm.

### ❖ Control Panel testing complete

1. Remove the jumper between the 523 and the 0 locations on the control panel terminal strip.
2. If any E Panel alarms are present, press enter to accept.

### ❖ Test results

1. Tests 1 and 2 pass:  
Move on to the next test "testing the oil temperature sender connections".
2. If either test 1 or test 2 failed:
  - 2.1 Repeat the open and short circuit testing directly at the back of the E Panel as follows:  
**Open:** The 523 wire should be removed from CON2-4.  
**Short:** With the 523 wire still removed, insert a jumper wire into CON2-4. Connect the other end of the jumper to ground (0).  
After testing, remove the jumper wire from CON2-4 and insert the 523 wire back into CON2-4.

### 2.2 Test results:

- 2.2.1 If these tests fail again directly at the back of the E Panel, then the E Panel has failed and should be replaced.
- 2.2.2 If these tests pass at the back of the E Panel, but failed at the terminal strip, then there is a wiring error between the E Panel and the terminal strip. Check this wiring carefully.

## ◆ TESTING THE OIL TEMPERATURE SENDER CONNECTIONS

### ❖ Visual Inspection

Carefully check the wiring between the oil temperature sender and the E Panel.

1. Check the 523 wire connection to the OTS.
  - 1.1 Check for a proper crimp on the lug.
  - 1.2 Check to see if the sender nut is tightened securely. Be careful not to over tighten the nut. If the nut is over tightened the stud will break free and cause incorrect sender readings. This nut should be tightened to 6 to 7 inch pounds.
  - 1.3 Check for any environmental corrosion on the lug or sender terminal. Generac recommends the following actions if corrosion is found:
    - 1.3.1 Replace the lug.
    - 1.3.2 Replace the sender if possible. If not possible, thoroughly remove all of the corrosion from the sender terminal.
    - 1.3.3 Protect the lug and sender terminal with an approved automotive dielectric grease.
2. Check the 523 wire in the Deutsch connector (only used on the "water tight connector" panels.)
  - 2.1 Refer to appendix A for information on the Deutsch connectors used.
  - 2.2 Refer to the unit's wiring diagram for the 523 location in the Deutsch plug.
3. Check the 523 wire on the control panel terminal strip.
  - 3.1 Check for a proper crimp on both lugs.
  - 3.2 Check to see if both screws are tightened securely. These screws should be tightened to 12 inch pounds.
4. Check the 523 wire going into CON2 on the back of the E Panel.
  - 4.1 Check to see if the wire is stripped properly inside the green plug. The wire conductor should be trapped inside the metal wire clamp. The wire insulation should not be trapped inside the metal wire clamp.



- 4.2 Check to see if the set screw is tightened securely, but do not over tighten. This screw should be set to 2 to 4 inch pounds.
5. Check for any wire damage along the entire run between the E Panel and the sender.
  - 5.1 Check for any areas along the wire with missing insulation. This could allow the 523 line to momentarily come into contact with ground causing a false shut down.
  - 5.2 Check to see if the wire is pinched anywhere along the run. A wire that is pinched between the sheet metal can cause the 523 wire to momentarily come into ground causing a false shut down. A pinched wire may also cause the wire to break inside the insulation, this could cause the 523 line to momentarily "open" while running. This will also result in a false shut down.

#### ✧ Check the OTS mounting

The ground return (0) connection for the OTS is made by the physical connection of the sender to the engine block. This connection may be made directly, or through a series of adapters or fittings.

Check for the following at each junction point:

1. Check for a tight mechanical connection.
2. Check for a good electrical connection.

#### ✧ Resistance measurements

Power down the E Panel by removing the front panel fuse.

Remove CON2 from the back of the E Panel.

1. Measure the resistance between the OTS stud and the 523 wire inside the control panel. If this measurement is greater than 2-3 Ohms, replace the entire wire running between the control panel and the OTS stud.
2. Measure the resistance between the body of the sender and the 0 location on the control panel terminal strip. If this measurement is greater than 2 -3 Ohms, go back and carefully check the OTS mounting and the star ground connections on the engine block.

## AC VOLTAGE DISPLAY

The E Panel monitors the generator's AC output voltage. This voltage can be viewed locally on the E Panel's display, or remotely using Genlink.

There are two user programmable set points for the Generator output voltage: over voltage and under voltage. Both parameters are active after the hold off timer has expired. They can be programmed to be a status message, non-latched alarm, latched alarm, or shut down alarm.

The voltage displayed on the E Panel, and the over/under voltage set points are all based on the generators full line to line output voltage. However, in most cases full line to line voltage is not connected to the E Panel. (Please refer to the unit's wiring diagram and schematic for complete wiring details.)

The E Panel has a programmable voltage scaling factor that is used to scale the sensing voltage applied to CON4-4 and CON4-6. This allows the E Panel to display full line to line voltage.

The scaling factor should be checked if the E Panel is not displaying the line to line voltage correctly.

Check the scaling factor against the generators set up sheet. If the set up sheet is not available, contact Generac's service department for the recommended setting.

The voltage scaling factor can also be used to "calibrate" the voltage display.

#### Example:

A 480 volt unit has 240 volts sensing voltage applied to E Panel CON4-4 and CON4-6.

The E Panels scaling factor should be set to 2.0 to provide a proper line to line display voltage.

If, however, the E Panel displays 490 volts with a scaling factor of 2.0, the scale factor may be adjusted slightly to "calibrate" the voltage display. In this case, the displayed voltage is roughly 2% high, so the scaling factor should be reduced by 2% to 1.96. Change the scaling factor and recheck the voltage display. If necessary, readjust the scaling factor until the voltage display is properly "calibrated".

Please note the following:

1. Software versions V1.07 and earlier had a one decimal point scale factor.  
Software versions V1.08 and later have a two decimal point scale factor.
2. The E Panel displayed voltage is not used in any way to regulate the generators output voltage. The voltage regulator is responsible for regulating generator voltage.

## RPM SENSOR AND ENGINE SPEED

### ALARMS (Refer to Figures 3.5, 3.6 & 3.7)

#### ◆ OVERVIEW

The E Panel uses an RPM sensor to monitor engine speed. The RPM sensor is mounted in the blower housing and positioned so the tip of the sensor is directly above the engine flywheel teeth. As the flywheel rotates, the sensor will send an electrical pulse to the E Panel each time a tooth passes the sensor. The E Panel will count these pulses and convert them into engine speed.



## Section 3 – Troubleshooting and Diagnosis

### E Option Control Panels

Figure 3.5 — RPM Sensor

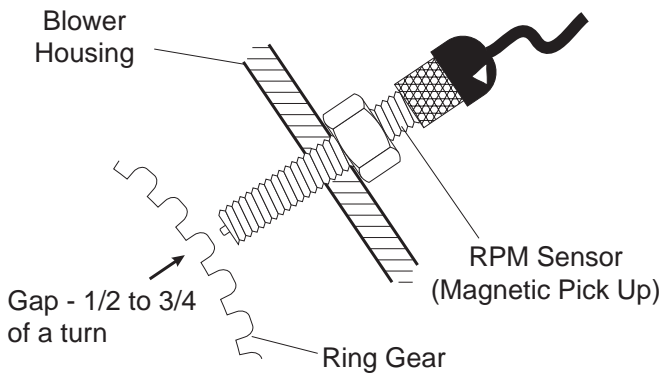

If the magnetic pickup is removed for any reason, it must be installed properly.

#### ◆ INSTALLATION

1. Rotate the ring gear until a gear tooth face is directly in the center of the tapped hole on the blower housing.

#### NOTE:

**Do NOT use the alternator fan to rotate the engine.**

2. Gently turn the magnetic pick up clockwise into the tapped hole until it bottoms on the gear tooth.
3. Use a marker to mark a line on the magnetic pick up threads and blower housing.
4. Using the lines marked in Step 3 as a guide, turn the magnetic pick up 1/2 to 3/4 of a turn counter-clockwise.
5. Tighten the jam nut securely.

#### ◆ RELATED ALARMS

##### ✧ RPM Sensor Loss

RPM sensor loss is a shut down alarm. There are two conditions that will result in RPM sensor loss.

1. No RPM signal at crank. The E Panel will monitor the RPM sensor during the crank cycle. If no signal is detected within a few seconds of cranking, the E Panel will display RPM Sensor Failure and shut down the engine.
2. RPM sensor loss while running. The E Panel continues to monitor the RPM sensor while running. If the signal is lost while running, the E Panel will display RPM sensor failure and shut down the engine.

##### ✧ Engine Under Speed

Engine under speed is a hold off alarm with a programmable set point. The alarm type is programmable as shutdown, latched, non-latched or status.

##### ✧ Engine Over Speed

Engine over speed is an immediate alarm with a programmable set point. Engine over speed is a shut down alarm.

#### ◆ TROUBLESHOOTING

1. Verify that all the following parameters have been correctly programmed into the E Panel.
  - 1.1 Number of flywheel teeth. The number of flywheel teeth is used by the E Panel to convert the electrical pulses from the RPM sensor, into engine speed. If this parameter is not programmed correctly, the E Panel will not be able to monitor engine speed correctly. Verify the number of flywheel teeth against the generator setup sheet. If the generator setup sheet is not available, contact Generac's service department for the REQUIRED setting.
  - 1.2 Over speed and under speed settings. Verify these settings against the generator setup sheet. If the generator setup sheet is not available, contact Generac's service department for the recommended settings.
2. Check the RPM sensor wiring. A two conductor shielded cable is used to connect the RPM sensor to the E Panel. It is important to very carefully check this wiring and all connections, including the shield connections.
  - 2.1 Cable description:
    - 2.1.1 Red wire (wire 79). The red wire inside the cable is wire number 79. This wire is used to connect the RPM signal from the sender to the E Panel.
    - 2.1.2 Black wire (wire 0). The black wire inside the cable is the 0 wire that connects the RPM sensor to the E Panel.

Figure 3.6 — Control Panel RPM Sensor Connections

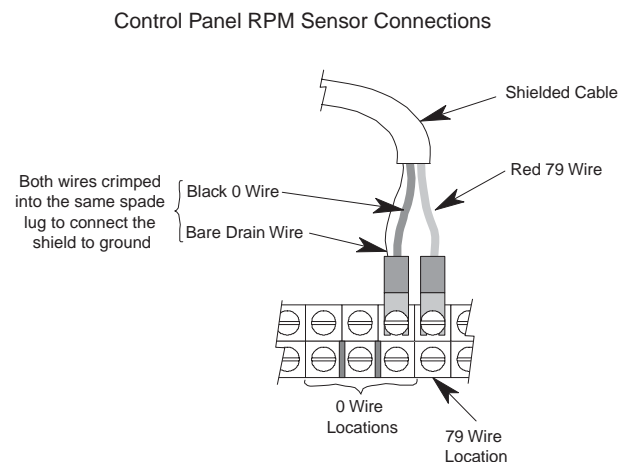



2.1.3 Shield/Drain wire. The shield is an aluminum foil shield that surrounds the two conductors and runs the entire length of the cable. The foil shield will be cut even with the cable jacket.

The drain wire is a non insulated wire that is in physical contact with the shield and also runs the entire length of the cable. The drain wire is used to make the shield connections.

The drain wire MUST be connected to system ground to shield the sensitive RPM sensor signal from noise. This ground connection is typically made at the control panel main terminal strip. Refer to Figure 3.6.

- 2.2 Check the cable at the RPM sensor. Look for breaks, signs of over stress, excessive tension, etc.
- 2.3 Check all of the connection points along the entire cable run (refer to the unit's wiring diagrams.) At each connection point, check for proper wire stripping, lugging, etc.
- 2.4 Drain wire connections. Carefully check the drain wire connections at each connection point. Figure 3.7 shows the different methods that may be used for connecting the drain wire. Note that the drain can be connected to the 0 wire at a connection point, or it can be run separately.

Figure 3.7 — RPM Sensor Engine Connections

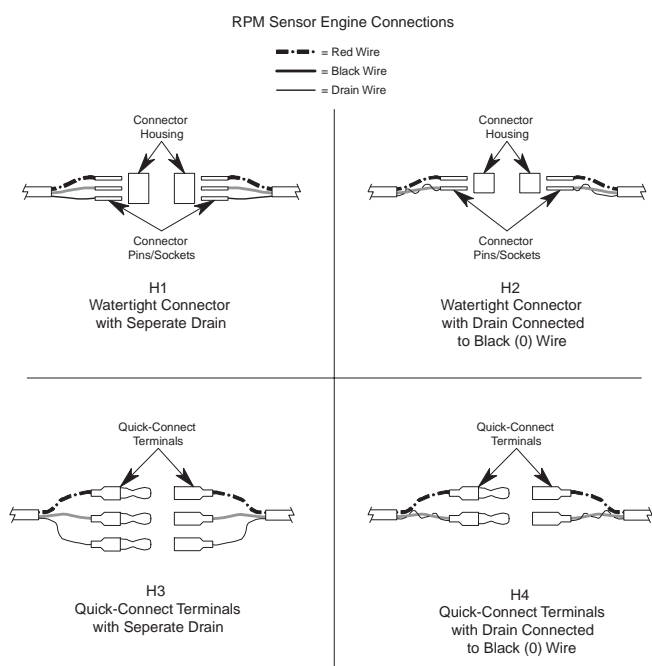

3. RPM sensor voltage measurement. The RPM sensor voltage can be measured at the control panel's main terminal strip. This voltage should be measured during crank and run.

**WARNING**

**Once the engine has started, there will be high voltage inside the generators control panel.**

- 3.1 Using an AC volt meter, measure the voltage at terminal positions 79 and 0.  
This voltage should measure as follows:  
**During crank:** 150 milli volts or greater (0.150V)  
**During run:** 500 milli volts or greater (0.500V)
- 3.2 If the voltages measured are lower than what is listed above do the following:
  - 3.2.1 Reset the RPM sensor. Refer to Figure 3.5 for the proper setting.

**NOTE:**

**The RPM sensor will have to be removed in order to be set properly. Do not strain (twist) the sender cable during this process. Units that have a connector at the sender can simply be disconnected. If a connector is not available, the cable will have to be removed from the wire harness and disconnected at the control panel.**

- 3.2.2 Retake the voltage measurements. If the voltages are still low, then the RPM sender is faulty and should be replaced.

## ENGINE DOES NOT CRANK

This section provides troubleshooting techniques that should be used if the engine fails to crank when a start signal is given.

### ◆ CHECK THE E PANEL START SETTINGS

All of the following start related parameters will be found in the Engine Parameters Menu.

These settings should be checked against the Generator setup sheet. If the generator setup sheet is not available, contact Generac's service department for the recommended settings.

1. Number of start attempts. This number defines the maximum number of times the E Panel will engage the starter. Verify this number is not set to zero.
2. Start timer. This number (in seconds) defines the length of time the E Panel will keep the starter energized during a start attempt. Verify this number is not set to zero.
3. Start attempt pause time. This number (in seconds) defines the length of time the E Panel will pause between start attempts.



4. Preheat option. Check to see how the Preheat option is set. If it is set as either "before start" or "before and during start" the preheat timer becomes active.
5. Preheat timer. This number (in seconds) defines the length of time the E Panel will preheat prior to cranking.

**Example:**

Preheat options: the preheat option is set to before start, and the preheat timer is set to 10.

Result: When a start signal is given, the E Panel will activate the preheat output for 10 seconds. Once that 10 seconds is over, it will activate the start and fuel outputs.

### ◆ TEST THE E PANEL KEY SWITCH

**NOTE:**

**Leave the key switch in each position for a few seconds. Turning the key too quickly may cause false test results.**

**WARNING**

**! The following steps will signal the generator to start and run.**

1. Place the key switch in the off position.
2. Use the left and right arrow keys to go to the Generator Command page.  
With the key switch in the off position, the display should read "Generator switch off".
3. Turn the key switch to the Auto position. The top line of the display should read "Generator in auto mode".
4. Turn the key switch to the manual position. In the manual position, the E Panel should begin the engine starting sequence. The display will continue updating to show the user the progress. This is discussed in detail in the next test.

If however, the E Panel display shows the key switch is in either the off or auto positions, the E Panel has failed and needs to be replaced.

### ◆ WATCH THE E PANEL DISPLAY DURING THE START ATTEMPT

**WARNING**

**! Warning: the following steps will signal the generator to start and run.**

1. Set the key switch to the off mode.
2. Use the left and right arrow keys to go to the screen "Generator switch off".
3. Turn the key switch to the manual position.
4. The E Panel display will begin displaying the start sequence as follows:

4.1 "Preheating": The E Panel is preheating the engine. (Only occurs if preheat is enabled.) The start output will not be active during this time, and the engine should not be cranking.

4.2 "Attempting to start": The E Panel is activating all the following outputs:

- 4.2.1 Start solenoid output at CON3-2.
- 4.2.2 Fuel solenoid output at CON3-1.
- 4.2.3 Preheat output at CON3-4 and 3-3 (Only if preheat is enabled.)

4.3 "Pausing before start": This indicates the E Panel is in a rest cycle between start attempts.

- 4.3.1 The start solenoid output will not be active.
- 4.3.2 The fuel solenoid output will not be active.
- 4.3.3 The Preheat output will be active (Only if preheat is enabled).

4.4 The start sequence will now begin cycling between "attempting to start" and "pause before start". This cycling will continue for the programmed number of cycles.

If the engine has not started by the end of the final cycle, the display will read "failed to start" and issue a shutdown alarm. This fault condition is referred to as over crank.

5. TEST RESULTS: Did the E Panel display "attempting to start" during the start cycle?

5.1 NO.

5.1.1 Go back and carefully check the start settings programmed into the E Panel.

5.1.2 Is there an alarm condition present which is preventing the E Panel from initiating the start sequence? If yes, they must be cleared before the E Panel will attempt to start.

5.1.3 If all of the programmable start parameters are correct, and there are no alarms present, then the E Panel has failed and needs to be replaced.

5.2 YES. — If the E Panel displayed "attempting to start" but the engine did not crank, move on to the next test.

### ◆ MEASURE THE START SIGNAL IN THE CONTROL PANEL (REFER TO FIGURE 3.8)

CON3-2 is the start output from the E Panel and should be at +battery (+12V or +24V) whenever the E Panel display reads "attempting to start."

Wire #56 is used to connect CON3-2 from the E Panel to the starter contactor.

All measurements in this test are DC volts with respect to ground (0) unless otherwise noted.



1. Measure the start output directly at CON3-2 on the back of the E Panel. This should read +12/24V whenever the E Panel display reads "attempting to start."
  - 1.1 If it does not, then the E Panel has failed and needs to be replaced.

**Figure 3.8 — Starter Contactor Connections**

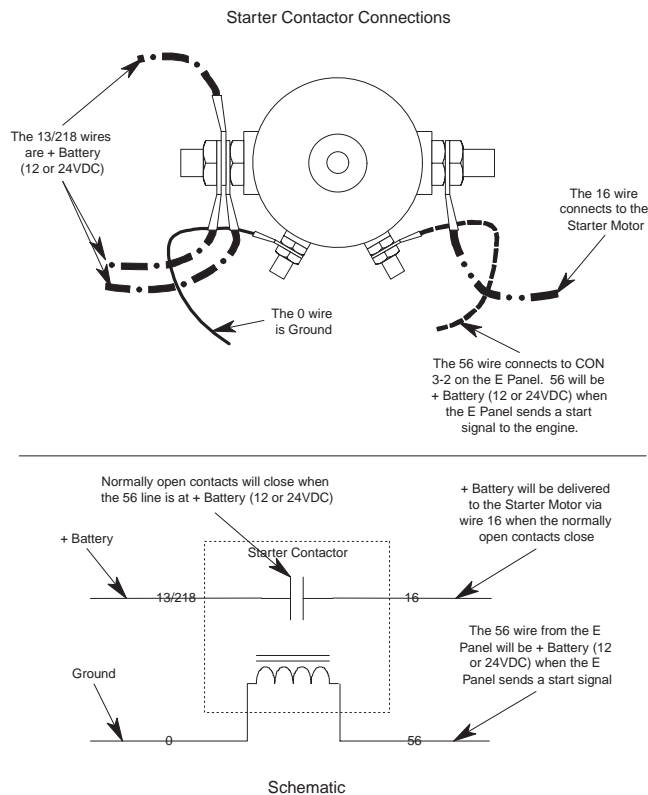

- 1.2 If it does read +12/24V, but the engine does not crank, then there is nothing wrong with the E Panel. Proceed to the next test.
2. Measure the 56 location on the control panels main terminal strip. This should read +12/24V whenever the E Panel display reads "attempting to start."
  - 2.1 If it does not, then carefully check the 56 wire between the E panel and the terminal strip.
  - 2.2 If it does read +12/24V, but the engine does not crank, move on to the next test.

◆ **CHECK THE CONDITION OF THE STARTER CONTACTOR CONNECTIONS**

1. Check for environmental corrosion on the terminals, nuts, or lugs. Generac recommends the following actions if corrosion is found:
  - 1.1 Replace the lugs.
  - 1.2 Thoroughly remove all of the corrosion from the contactor terminals.

- 1.3 Protect the lugs and terminals with an approved automotive dielectric grease.
2. Check to see if the terminal nuts are tightened securely, but be careful not to over tighten them.
  - 2.1 Coil terminals (10-32 studs and nuts). These nuts should be tightened to 12 to 15 inch pounds.
  - 2.2 Contact terminals (5/16-24 studs and nuts). These nuts should be tightened to 30 to 36 inch pounds.

◆ **MEASURE THE START SIGNAL AT THE STARTER CONTACTOR**

1. Measure the 56 connection at the start contactor. This should read +12/24V whenever the E Panel display reads "attempting to start."
  - 1.1 If it does not, then carefully check the 56 wire between the terminal strip and the starter contactor.
  - 1.2 If it does read +12/24V, but the engine does not crank, move on to the next test.
2. Check the 0 connection at the starter contactor. The 0 connection at the starter contactor can be checked as follows:
  - 2.1 Connect the negative volt meter lead to the 0 at the starter contactor.
  - 2.2 Connect the positive volt meter lead to the a 13/218 location inside the control panel.
  - 2.3 The voltmeter should read +12/24Volts. If it does not, there is a problem with the 0 connection to the starter contactor. Very carefully check all 0 connections including the star ground on the engine block.
3. Measure the 13/218 wire at the starter contactor. This should read +12/24V any time the battery is connected.
  - 3.1 If it does not, then carefully check the 13/218 wiring between the battery and the starter contactor.
  - 3.2 If it does read +12/24V, but the engine does not crank, move on to the next test.
4. Measure the 16 wire at the starter contactor. This should read +12/24V whenever the E Panel reads "attempting to start".
  - 4.1 If it does not, then the starter contactor is bad and needs to be replaced.
  - 4.2 If it does read +12/24V, but the engine does not crank, move on to the next test.
5. Measure the 16 wire at the starter motor. This should read +12/24V whenever the E Panel reads "attempting to start".
  - 5.1 If it does not, then carefully check the 16 wire running between the starter contactor and the starter itself.



- 5.2 If it does read +12/24V, but the engine does not crank, then test the starter solenoid and the starter motor as outlined in the appropriate engine service manual.

## OVERCRANK

### ◆ FAILED TO START

When the E Panel receives a start signal, it initiates the programmed starting sequence. The start sequence consists of the number of crank attempts, the length of each crank attempt, and the rest time between each crank attempt. If the engine has not started by the end of the final crank attempt, an Overcrank alarm is generated, the E Panel will sound the alarm and display the message "Failed to start".

#### ✧ Check the E Panel start settings

All of the following start related parameters will be found in the Engine Parameters Menu.

These settings should be checked against the Generator setup sheet. If the generator setup sheet is not available, contact Generac's service department for the recommended settings.

1. Number of start attempts: This number defines the maximum number of times the E Panel will engage the starter. Verify this number is not set to zero.
2. Start timer: This number (in seconds) defines the length of time the E Panel will keep the starter energized during a start attempt. Verify this number is not set to zero.
3. Start attempt pause time: This number (in seconds) defines the length of time the E Panel will pause between start attempts.
4. Preheat option: Check to see how the Preheat option is set. If it is set as either "before start" or "before and during start" the preheat timer becomes active.
5. Preheat timer: This number (in seconds) defines the length of time the E Panel will preheat prior to cranking.

#### Example:

Preheat options: The preheat option is set to before and during, and the preheat timer is set to 5.

Result: When a start signal is given, the E Panel will activate the preheat output for 5 seconds. Once that 5 seconds is over, it will activate the start, fuel and preheat outputs.

#### ✧ Check the fuel output from the E Panel

CON3-1 is the fuel output from the E Panel and should be high (+12 or +24V DC) whenever the E Panel is displaying "attempting to start."

Wire number 14/219 is used to connect CON3-1 from the E Panel to the fuel solenoid. (Wire #14 used in a 12 volt system, wire #219 used in a 24 volt system.)

All measurements in this test are DC volts with respect to ground (0) unless otherwise noted.

1. Measure the fuel output directly at CON3-1 on the back of the E Panel. This should read +12/24V whenever the E Panel display reads "attempting to start." (crank cycle). This will not read +12/24V when the E Panel display reads "Pausing before start." (rest cycle).
  - 1.1 If it does not, then the E Panel has failed and needs to be replaced.
  - 1.2 If it does, then there is nothing wrong with the E Panel, proceed to the next test.
2. Measure the 14/219 location on the control panels main terminal strip. This measurement should be the same as in step 1.
  - 2.1 If it is not, then carefully check the wiring between the E Panel and the terminal strip. There are two basic methods for the 14/219 wiring between the E Panel and the terminal strip. Refer to the unit's wiring diagram for the method used.
    - 2.1.1 Direct wiring: In this method, a wire is run from CON3-1 on the back of the E Panel directly to the 14/219 location on the terminal strip.
    - 2.1.2 Secondary relay: In this method, a secondary relay is used between the E Panel and the terminal strip. Refer to Figure 3.9 for a typical wiring schematic.
  - 2.2 If it does read correctly: If the 14/219 location on the control panel terminal strip reads correctly, there is nothing wrong with the control system.
 

This means the problem is external to the control panel and may include the fuel supply, fuel solenoid/injector pump, ignition system, or the wiring connecting these components.

Refer to the appropriate engine service manual for further troubleshooting techniques.



Figure 3.9 is a typical wiring schematic using a secondary relay for the E Panel fuel output. Refer to the unit's wiring schematics and diagrams to determine if a secondary relay is used and for specific connections.

When the E Panel supplies + battery voltage (12 or 24VDC) from CON3-1 through wire 14A/219A, the secondary relay is energized. The relay's normally open contacts will close, delivering + battery voltage to the 14/219 location on the control panel terminal strip.

Figure 3.9 — Typical Wiring Schematic Using a Secondary Fuel Relay

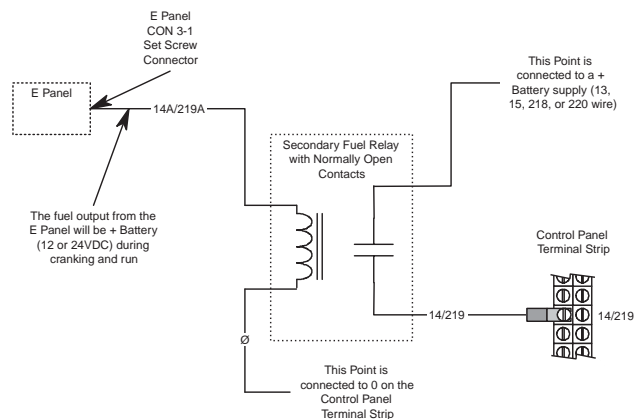

Appendix – Phoenix and Deutsch Connectors  
E Option Control Panels



Phoenix Combicon Connections

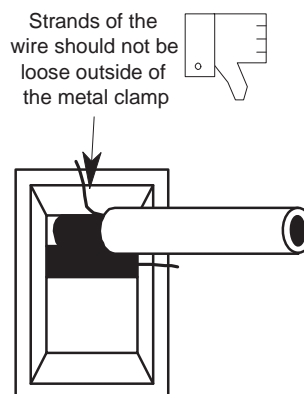
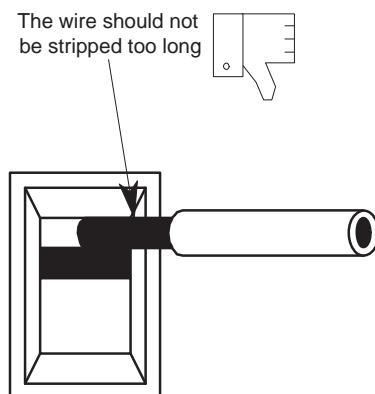
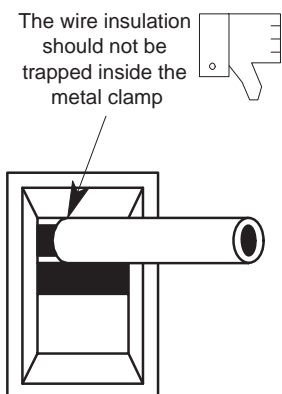
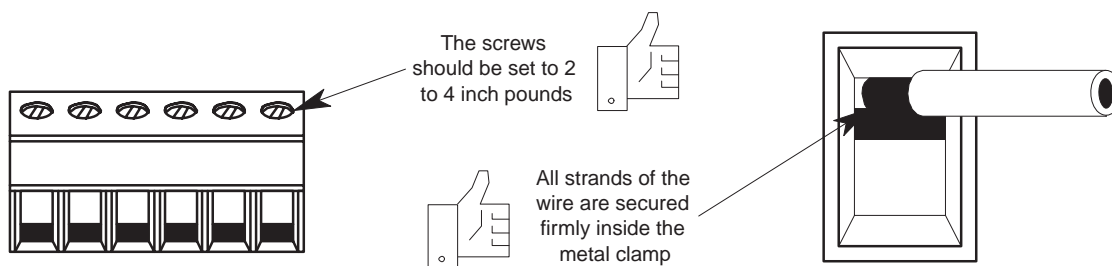

**HD30 Type**

**Step 1: Contact Removal**

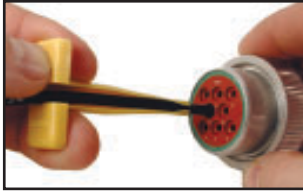

1. With rear insert toward you, snap appropriate size extractor tool over the wire of contact to be removed.



2. Slide tool along into the insert cavity until it engages contact and resistance is felt.

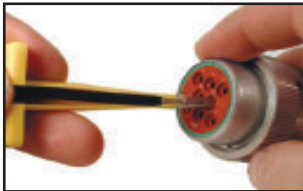

3. Pull contact-wire assembly out of connector.  
**NOTE:** Do not twist tool or insert at an angle.

**Step 2: Wire Stripping**

**Solid Contacts**

Contact Part Number	Wire Gauge Range	Strip Length (inches)
0460-202-20141 0462-201-20141	20 AWG	.156-.218
0460-202-16141 0462-201-16141	16, 18 & 20 AWG	.250-.312
0460-215-16141 0462-209-16141	14 AWG	.250-.312
0460-204-12141 0462-203-12141	12 & 14 AWG	.222-.284
0460-204-08141 0462-203-08141	8 & 10 AWG	.430-.492
0460-204-0490 0462-203-04141	6 AWG	.430-.492

**Step 3: Contact Crimping**

Use Crimp Tool #HDT48-00



1. Strip insulation from wire. (See Step 2).  
 2. Raise selector knob and rotate until arrow is aligned with wire size to be crimped.  
 3. Loosen locknut, turn adjusting screw in until it stops.



4. Insert contact with barrel up. Turn adjusting screw counter-clockwise until contact is flush with indenter cover. Tighten locknut.



5. Insert wire into contact. Contact must be centered between indicators. Close handles until crimp cycle is completed.  
 6. Release handles and remove crimped contact.



7. Inspect terminal to ensure that all strands are in crimp barrel.**NOTE:** Tool must be readjusted for each type/size of contact. Use HDT04-08 for size 8 and 4 contacts.

**Step 4: Contact Insertion**



1. Grasp contact approximately (25.4 mm) one inch behind the contact crimp barrel.



2. Hold connector with rear grommet facing you.



3. Push contact straight into connector grommet until a positive stop is felt. A slight tug will confirm that the contact is properly locked in place.

**NOTE:** For unused wire cavities, insert sealing plugs for full environmental sealing



### DT Type

#### Step 1: Contact Removal

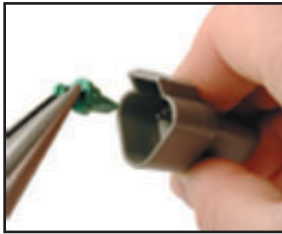

1. Remove wedgelock using needle-nose pliers or a hook shaped wire. Pull wedge straight out.



2. To remove the contacts, gently pull wire backwards, while at the same time releasing the locking finger by moving it away from the contact with a screwdriver.



3. Hold the rear seal in place, as removing the contact may displace the seal.

#### Step 2: Wire Stripping

##### Solid Contacts

Contact Part Number	Wire Gauge Range	Strip Length (inches)
0460-202-20141 0462-201-20141	20AWG	.156-.218
0460-202-16141 0462-201-16141	16, 18 & 20AWG	.250-.312
0460-215-16141 0462-209-16141	14AWG	.250-.312
0460-204-12141 0462-203-12141	12 & 14AWG	.222-.284
0460-204-08141 0462-203-08141	8 & 10AWG	.430-.492
0460-204-0490 0462-203-04141	6AWG	.430-.492

#### Step 3: Contact Crimping

Use Crimp Tool #HDT48-00

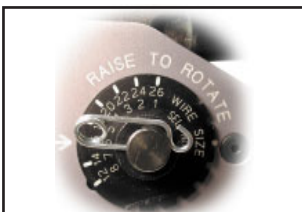

1. Strip insulation from wire. (See Step 2).  
2. Raise selector knob and rotate until arrow is aligned with wire size to be crimped.  
3. Loosen locknut, turn adjusting screw in until it stops.



4. Insert contact with barrel up. Turn adjusting screw counter-clockwise until contact is flush with indenter cover. Tighten locknut.



5. Insert wire into contact. Contact must be centered between indicators. Close handles until crimp cycle is completed.  
6. Release handles and remove crimped contact.

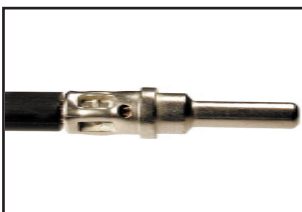

7. Inspect terminal to ensure that all strands are in crimp barrel. **NOTE:** Tool must be readjusted for each type/size of contact. Use HDT04-08 for size 8 and 4 contacts.

#### Step 4: Contact Insertion

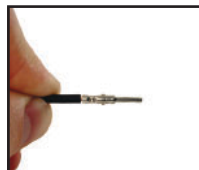

1. Grasp crimped contact approximately (25.2 mm) one inch behind the contact barrel.



2. Hold connector with rear grommet facing you.



3. Push contact straight into connector grommet until a click is felt. A slight tug will confirm that contact is properly locked in place.



4. Once all contacts are in place, insert wedgelock with arrow pointing toward exterior locking mechanism. The wedgelock will snap into place. Rectangular wedges are not oriented. They may go in either way. **NOTE:** The receptacle is shown –use the same procedure for plug.





## E CONTROL PANEL DEFINITIONS

Please refer to the following list for an explanation of terms used in various charts throughout the manual:

- **ALWAYS:** With this option selected, the alarm is active regardless of the state of the generator.
- **ANALOG INPUT:** An analog input to the E control panel is a voltage sourced input with a zero volt to 10-volt range.
- **DIGITAL INPUT:** A digital input to the E control panel is NOT a voltage sourced input, but a dry contact closure to ground. Voltage should never be sourced to a digital input.
- **DISABLED:** If this option is selected, the alarm is disabled and has no effect.
- **HIGH:** A high signal to a digital input is open circuit.
- **HOLD OFF:** This option waits until a preset time after the generator is running before becoming active. The hold off time can be set by the user. Note that the hold off time is common to all alarms.
- **IMMEDIATE:** In this mode, the alarm is not active when the generator is stationary. It becomes active as soon as the generator starts to crank and remains active until the generator stops.
- **LATCHED:** When the alarm condition occurs, the audible alarm sounds, the LED and back light flash as before, and the user must accept the alarm to stop them. The alarm will continue to be displayed on the screen even after the alarm condition has cleared. The user must either press the Reset key or turn the key-switch to the OFF position to clear the alarm after the alarm condition has cleared. This type of alarm is logged.
- **LOW:** A low signal to a digital input is a contact closure to ground.
- **NON-LATCHED:** This type of warning will activate the audible alarm, and flash the alarm LED and display back light. The associated message will be displayed on the screen. When the user accepts the warning (by pressing the Enter key), the back light will stop flashing, and the alarm LED will be on continuously. The message will be displayed on the alarm screen, but the user will be able to scroll through other screens. The LED and message will clear when the warning condition clears. This type of warning is logged.
- **SHUTDOWN:** This type of alarm will act similar to the latched alarm, but it also will stop the engine when the alarm condition occurs. It can be reset only by turning the key-switch to the OFF position. All shutdown alarms are latching, and this type of alarm is logged.
- **STATUS:** This type of alarm will display a message on the screen. The message will not be logged. This is the lowest priority of alarm types.
- **USER INPUT:** Any of the eight digital or two analog inputs reserved for customer options.



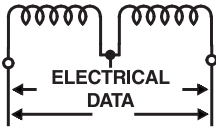

## Section 5 – Electrical Data

### Wiring Diagram (For use with Marathon Alternator) – Drawing No. 0D4267A-A For units manufactured with a watertight connector.

Standard diagram. Please refer to the Owner's Manual of the unit for specific details.

- LEGEND**
- BC2 - BILGEHEAD CONNECTOR (GOVERNOR)
  - BC3 - BILGEHEAD CONNECTOR (ALTERNATOR)
  - GC - GOVERNOR CONTROLLER
  - TB1 - TERMINAL BLOCK (50 POS)
  - TB2 - TERMINAL BLOCK (50 POS)
  - TB3 - TERMINAL BLOCK (34 POS)
  - TB4 - TERMINAL BLOCK (50 POS)
  - TB5 - TERMINAL BLOCK (50 POS)
  - R1 - CA EXCITER RESISTOR
  - R2 - CA EXCITER RESISTOR



**NOTES:**  
ALL WIRING IS AWG UNLESS NOTED.  
REQUIRED WIRING  
OPTIONAL WIRING  
FIELD WIRING

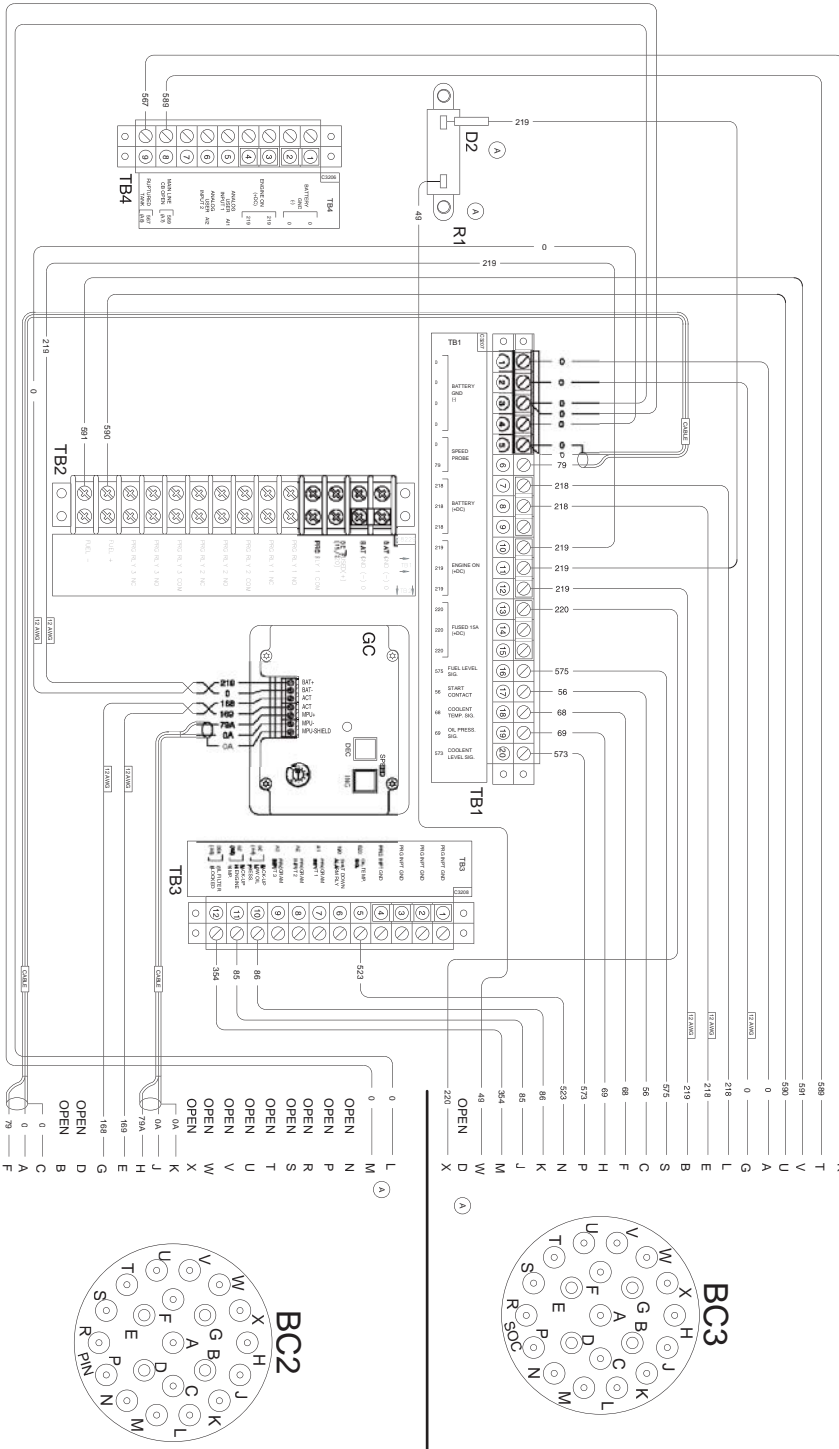

## Section 5 – Electrical Data

### Wiring Diagram (For use with Marathon Alternator) – Drawing No. 0D4267C For units manufactured with a watertight connector.

**Standard diagram. Please refer to the Owner's Manual of the unit for specific details.**

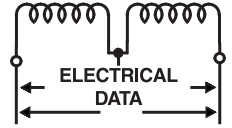

LOWER PANEL CONNECTOR (SEE DRG. 0A8513)

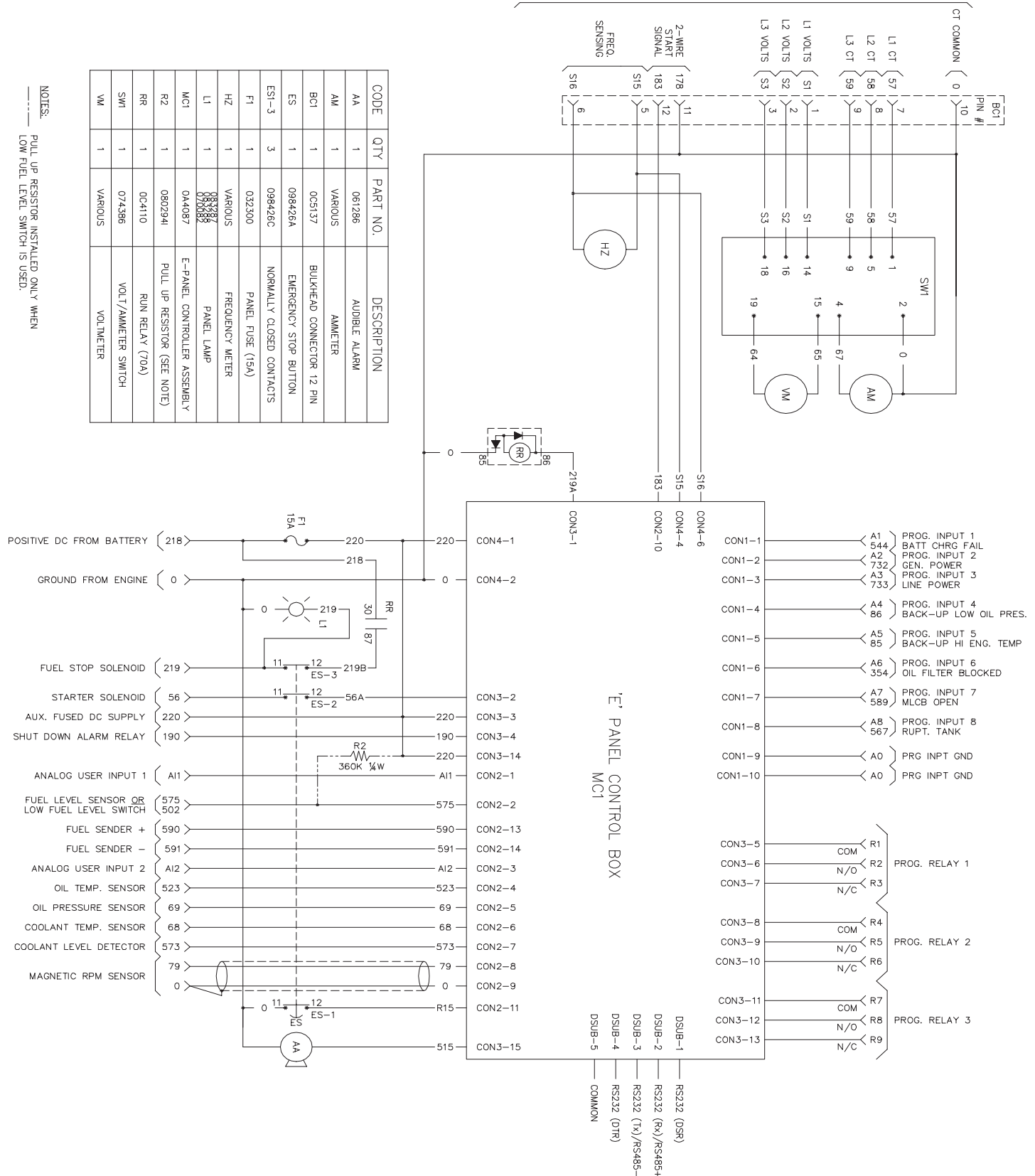

CODE	QTY	PART NO.	DESCRIPTION
AA	1	061286	AUDIBLE ALARM
AM	1	VARIOUS	AMMETER
BCI	1	0C5137	BULKHEAD CONNECTOR 12 PIN
ES	1	098426A	EMERGENCY STOP BUTTON
ES1-3	3	098426C	NORMALLY CLOSED CONTACTS
F1	1	032300	PANEL FUSE (15A)
HZ	1	VARIOUS	FREQUENCY METER
L1	1	083287 083288 083289	PANEL LAMP
MCI	1	044087	E-PANEL CONTROLLER ASSEMBLY
R2	1	080294I	PULL UP RESISTOR (SEE NOTE)
RR	1	0C4110	RUN RELAY (70A)
SWI	1	074386	VOLT/AMMETER SWITCH
VM	1	VARIOUS	VOLTMETER

NOTES:  
PULL UP RESISTOR INSTALLED ONLY WHEN  
LOW FUEL LEVEL SWITCH IS USED.



## Section 5 – Electrical Data

### Wiring Diagram (For Use With Marathon Alternator) – Drawing No. 0D4267-A For units manufactured with a watertight connector. Standard diagram. Please refer to the Owner's Manual of the unit for specific details.

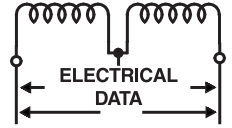

LOCATED ON FRONT OF PANEL

NOTES:

ALL WIRING 18 AWG UNLESS NOTED.

— REQUIRED WIRING.

- - - OPTIONAL WIRING.

▬ CABLE ▬ SHIELDED CABLE

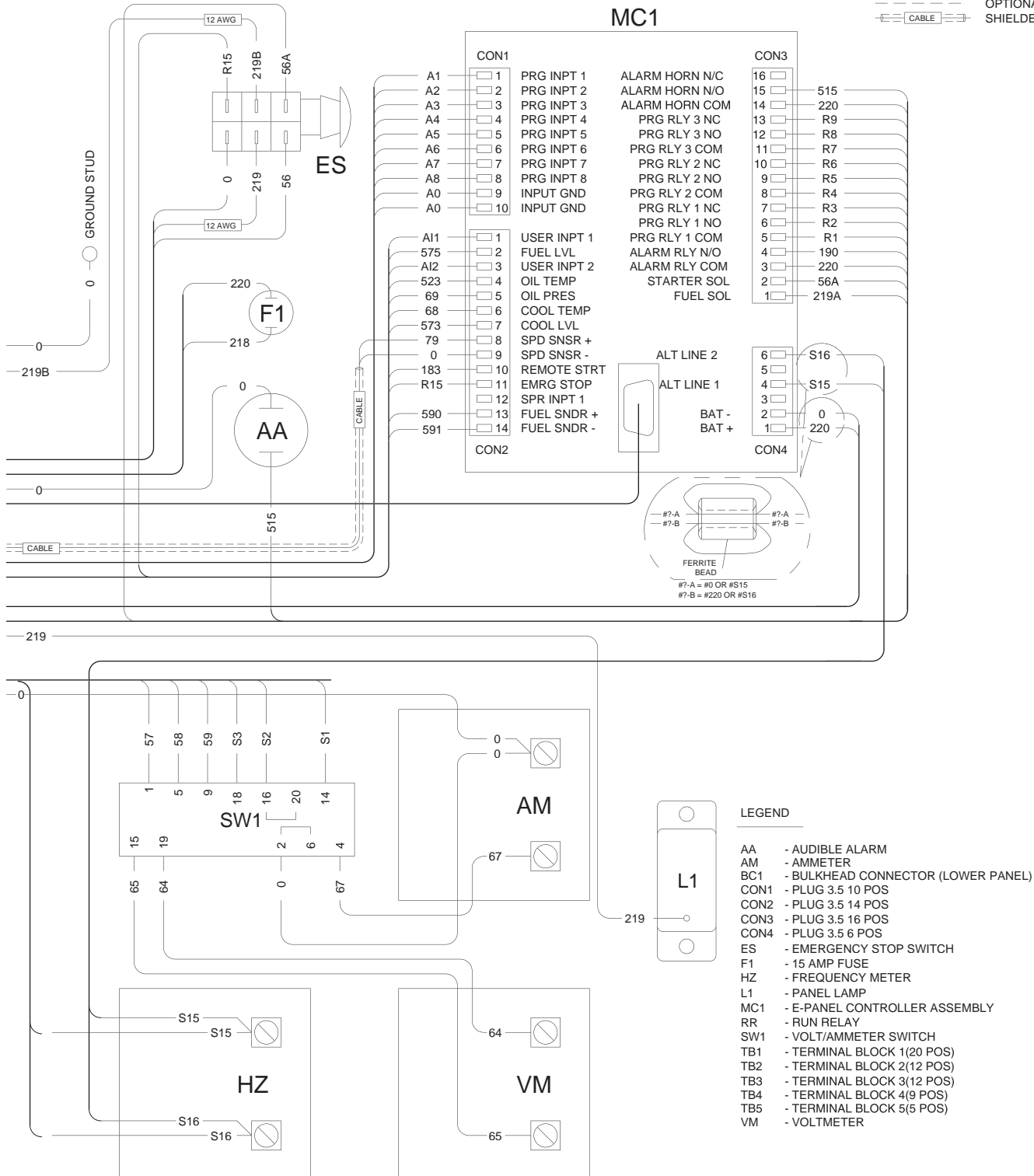



## Section 5 – Electrical Data

### Wiring Diagram (For Use With Generac Alternator) – Drawing No. 0D2378-C

For units manufactured with a watertight connector.

Standard diagram. Please refer to the Owner's Manual of the unit for specific details.

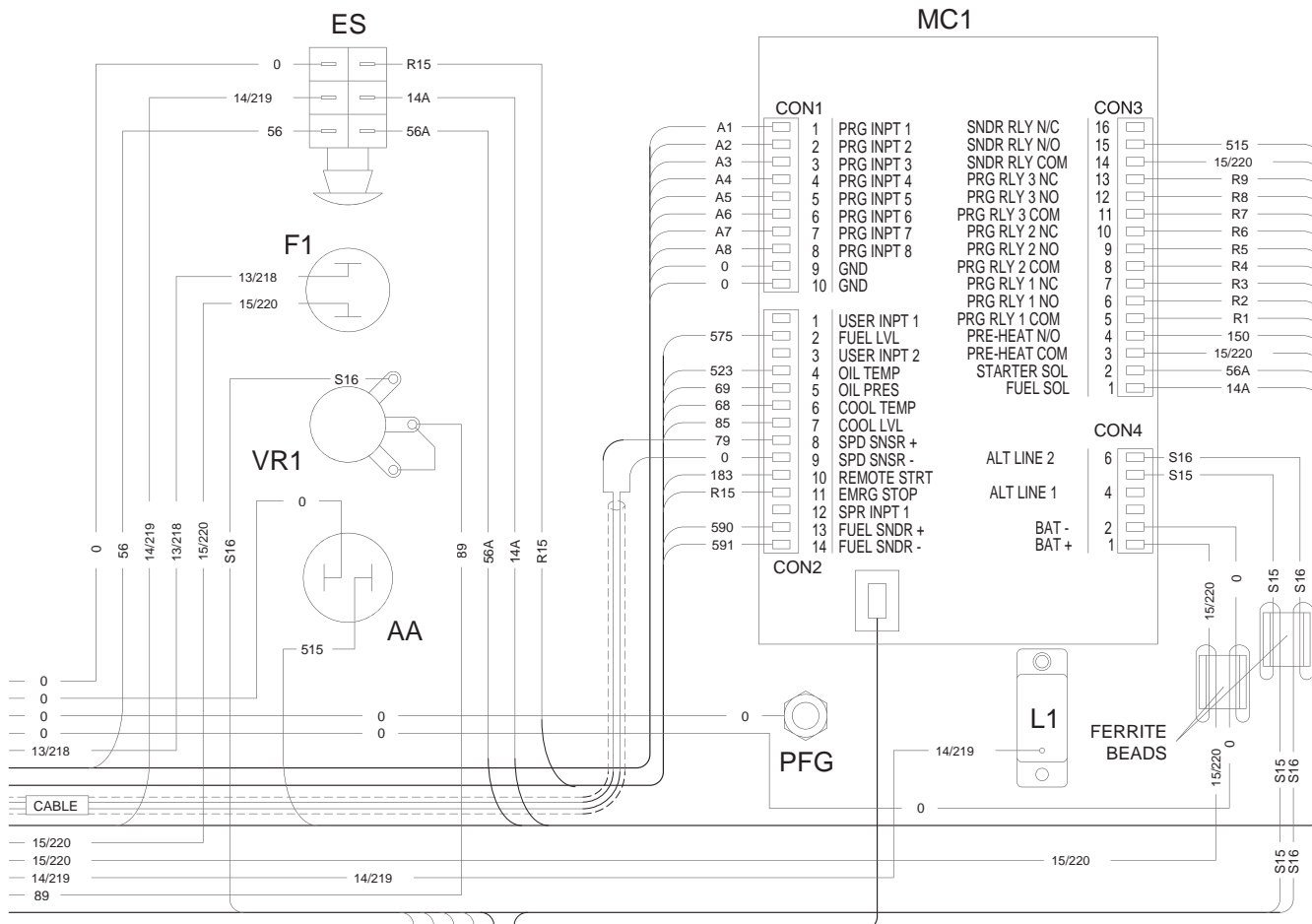
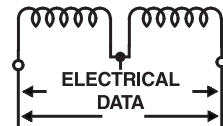

WIRE COLOR LEGEND	FUNCTION	WIRE #'s
WHITE	NEUTRAL	0,1,R15,591
RED	NON-FUSED DC	4,13,29,218
ORANGE	FUSED DC	14,15,219,220
BROWN	CONTROL	56,56A,57-59,67,89 162,178,183,S1-3,590
BLUE	SIGNAL/SENSING	2,49,150,A1-8,R1-9 S15,S16,64,65
BLACK	AC/MISC	6
YELLOW	UNIT STATUS	68,69,85,502,509, 515,523,567,575,589

### LEGEND

- AA = AUDIBLE ALARM
- AM = AMMETER
- ES = EMERGENCY STOP SWITCH
- F1 = 15 AMP AGC TYPE FUSE
- HZ = FREQUENCY METER
- L1 = PANEL LAMP
- MC1 = E-PANEL CONTROL ASSEMBLY
- PFG = PANEL FRONT GROUND STUD
- SW1 = VOLT/AMMETER SWITCH
- VM = VOLT METER
- VR1 = VOLTS TRIM POTENTIOMETER

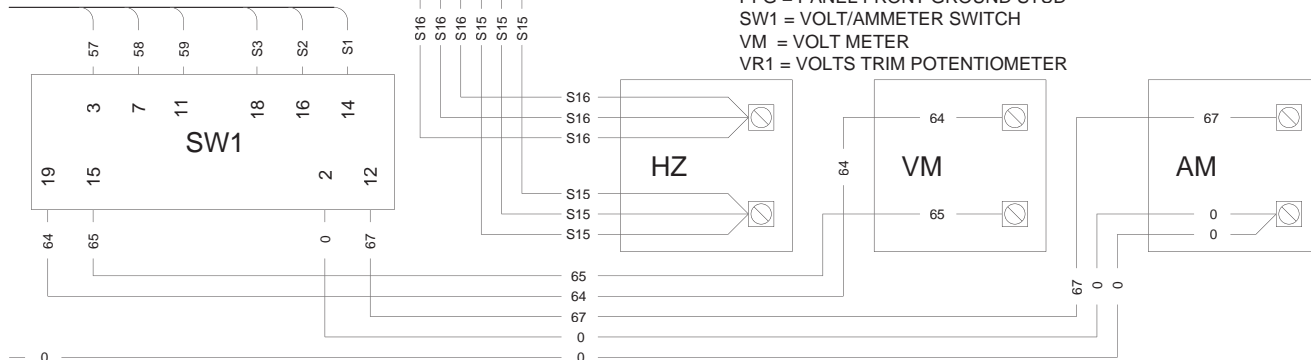

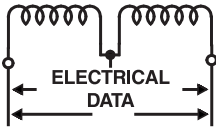

**Section 5 – Electrical Data**

**Schematic Diagram (For Use With Generac Alternator) – Drawing No. 0D2379**

For units manufactured with a watertight connector.

Standard diagram. Please refer to the Owner’s Manual of the unit for specific details.

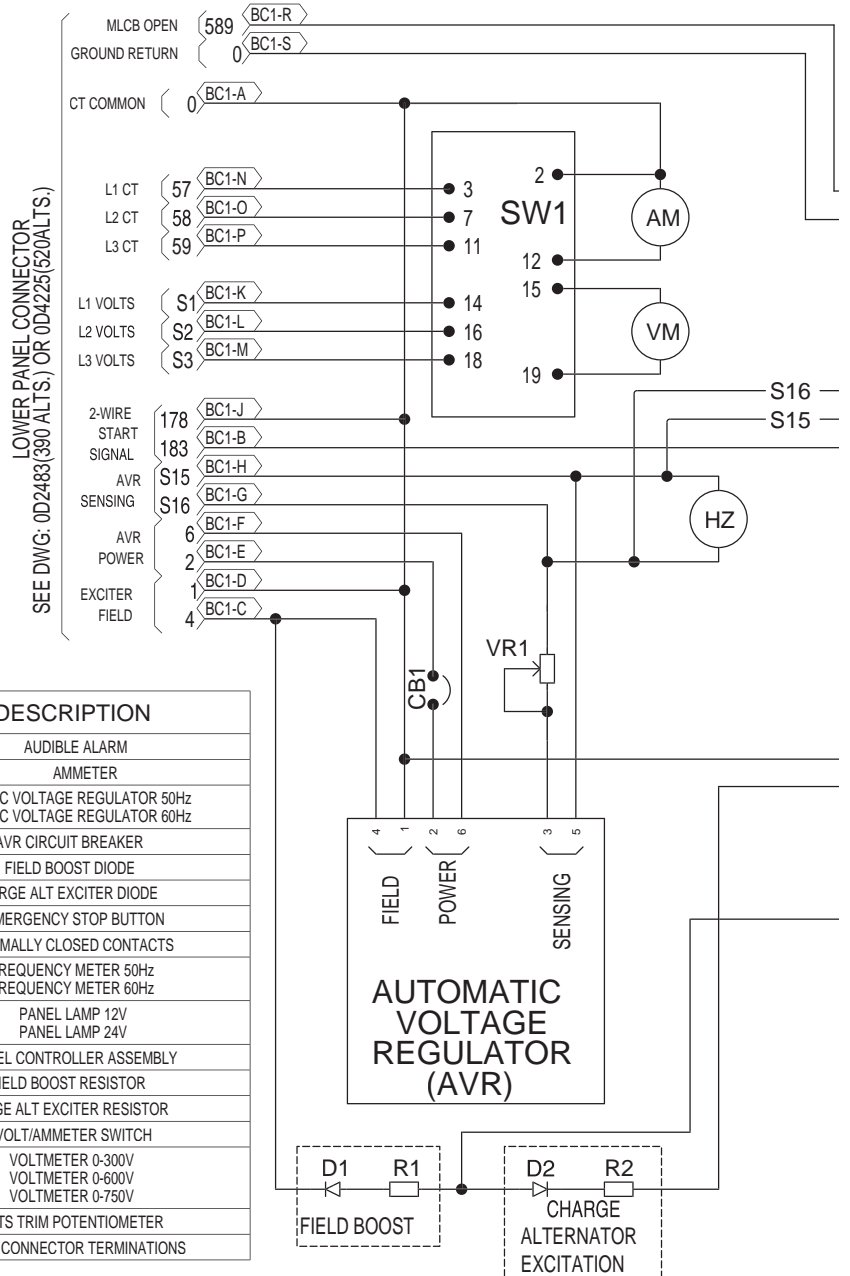

CODE	P/N:	DESCRIPTION
AA	061286	AUDIBLE ALARM
AM	VARIOUS	AMMETER
AVR	067680 092952	AUTOMATIC VOLTAGE REGULATOR 50Hz AUTOMATIC VOLTAGE REGULATOR 60Hz
CB1	VARIOUS	AVR CIRCUIT BREAKER
D1	049939	FIELD BOOST DIODE
D2	025192	CHARGE ALT EXCITER DIODE
ES	098426A	EMERGENCY STOP BUTTON
ES1-3	098426C	NORMALLY CLOSED CONTACTS
HZ	070042 070042A	FREQUENCY METER 50Hz FREQUENCY METER 60Hz
L1	0C8481 070202	PANEL LAMP 12V PANEL LAMP 24V
MC1	0A4087	E-PANEL CONTROLLER ASSEMBLY
R1	VARIOUS	FIELD BOOST RESISTOR
R2	044213	CHARGE ALT EXCITER RESISTOR
SW1	061945	VOLT/AMMETER SWITCH
VM	070043 070044 082404	VOLTMETER 0-300V VOLTMETER 0-600V VOLTMETER 0-750V
VR1	071361	VOLTS TRIM POTENTIOMETER
XXX-X	REFERENCE	E-PANEL CONNECTOR TERMINATIONS

WIRE COLOR LEGEND	FUNCTION	WIRE #'s
WHITE	NEUTRAL	0,1,R15,591
RED	NON-FUSED DC	4,13,29,218
ORANGE	FUSED DC	14,15,219,220
BROWN	CONTROL	56,56A,57-59,67,89 162,178,183,S1-3
BLUE	SIGNAL/SENSING	2,49,150,A1-8,R1-9 S15,S16,64,65
BLACK	AC/MISC	6
YELLOW	UNIT STATUS	68,69,85,502,509,515 523,567,575,589

Schematic Diagram (For Use With Generac Alternator) – Drawing No. 0D2379

For units manufactured with a watertight connector.

Standard diagram. Please refer to the Owner's Manual of the unit for specific details.

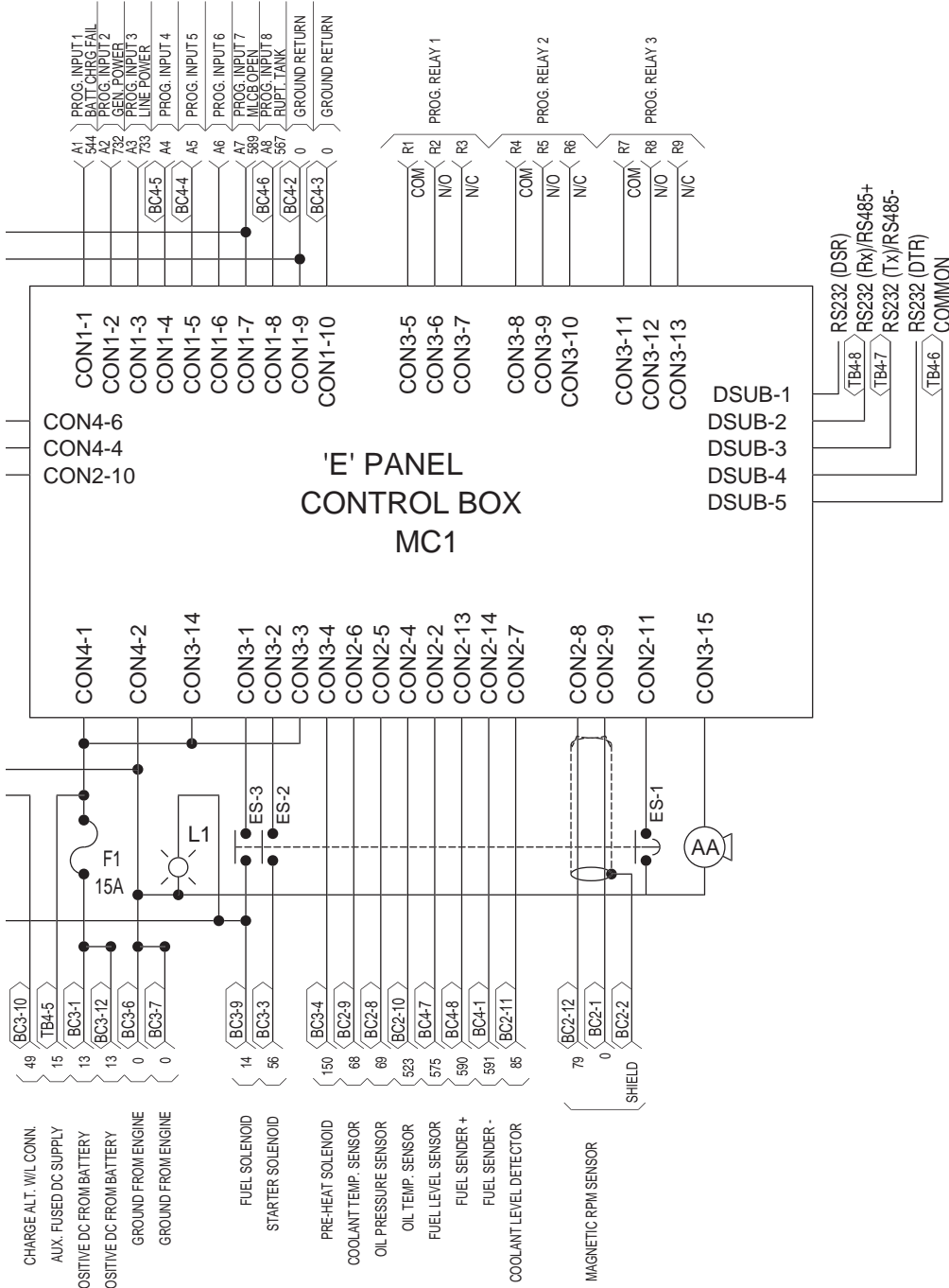
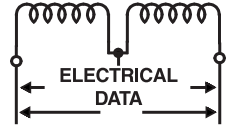

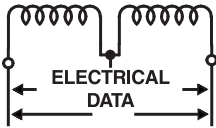

**Section 5 – Electrical Data**

**Wiring Diagram (For Use With Generac Alternator) – Drawing No. 0C8319-E**

For units manufactured starting the 2nd quarter of 2000 thru 3rd quarter 2002.

Standard diagram. Please refer to the Owner's Manual of the unit for specific details.

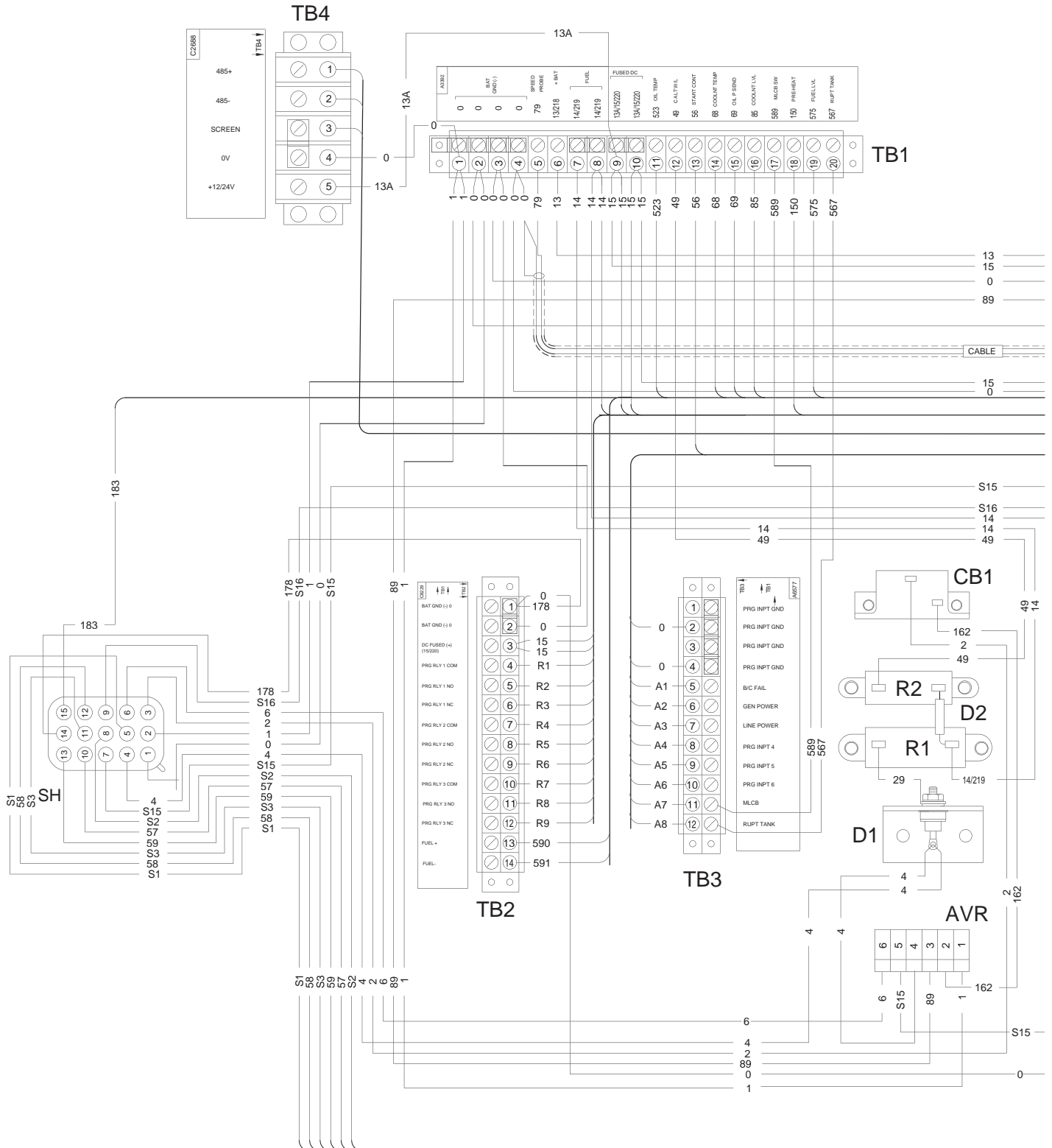

## Section 5 – Electrical Data

**Wiring Diagram (For Use With Generac Alternator) – Drawing No. 0C8319-E**  
**For units manufactured starting the 2nd quarter of 2000 thru 3rd quarter 2002.**  
**Standard diagram. Please refer to the Owner's Manual of the unit for specific details.**

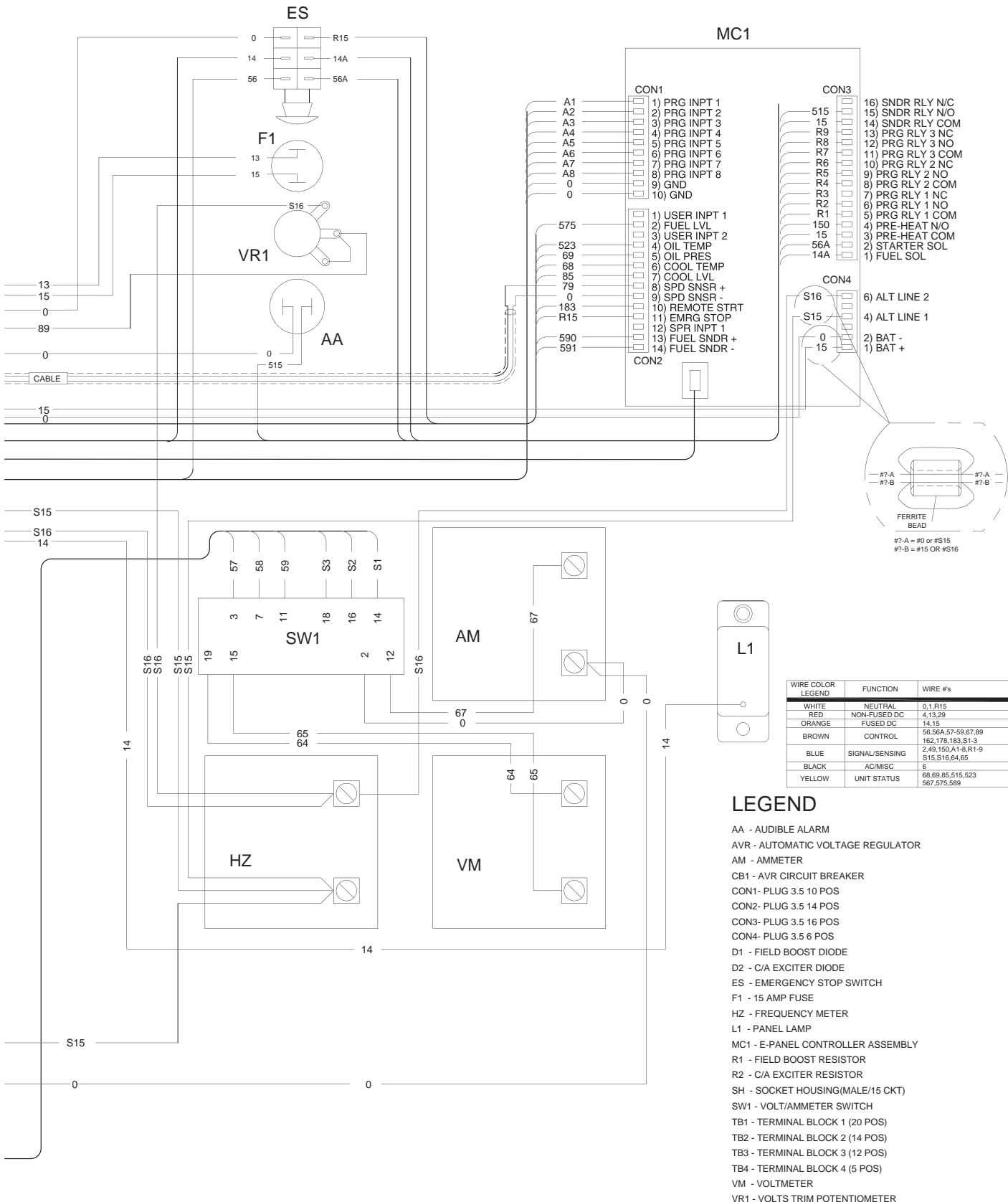
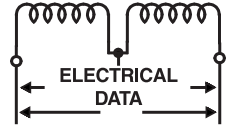

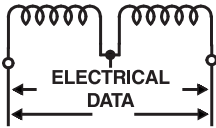

## Section 5 – Electrical Data

### Schematic Diagram (For Use With Generac Alternator) – Drawing No. 0C8318

For units manufactured starting the 2nd quarter of 2000 thru 3rd quarter 2002.

Standard diagram. Please refer to the Owner's Manual of the unit for specific details.

WIRE COLOR	FUNCTION	WIRE #'S
<b>LEGEND</b>		
WHITE	NEUTRAL	D1,R1S
RED	NON-FUSED DC	4,13,29
ORANGE	FUSED DC	14,15
BROWN	CONTROL	56,56A,57-59,67,89
BLUE	SIGNAL/SENSING	162,178,183,S1-3
BLACK	AC/MISC	2,49,150,A1-8,R1-9
YELLOW	UNIT STATUS	6
		56,69,85,S1S,523
		56,7,57S,589

CODE	QTY	PART NO.	DESCRIPTION
AA	1	61286	AUDI BLE ALARM
AM	1	VARIOUS	AMMETER
AVR	1	67680	AUTOMATIC VOLTAGE REGULATOR
CB1	1	VARIOUS	AVR CIRCUIT BREAKER
D1	1	49399	FIELD BOOST DIODE
D2	1	29192	CHARGE ALT EXCITER DIODE
ES	1	99484A	EMERGENCY STOP BUTTON
ES1-3	3	99484C	NORMALLY CLOSED CONTACTS

HZ	PART NO.	FREQUENCY METER
L1	70202	PANEL LAMP
MCI	A4087	E-PANEL CONTROLLER ASSEMBLY
R1	44213	FIELD BOOST RESISTOR
R2	44213	CHARGE ALT EXCITER RESISTOR
SM1	61945	VOLTAGEMETER SWITCH
VM	1	VOLTMETER
VR1	1	VOLTS TRIM POTENTIOMETER

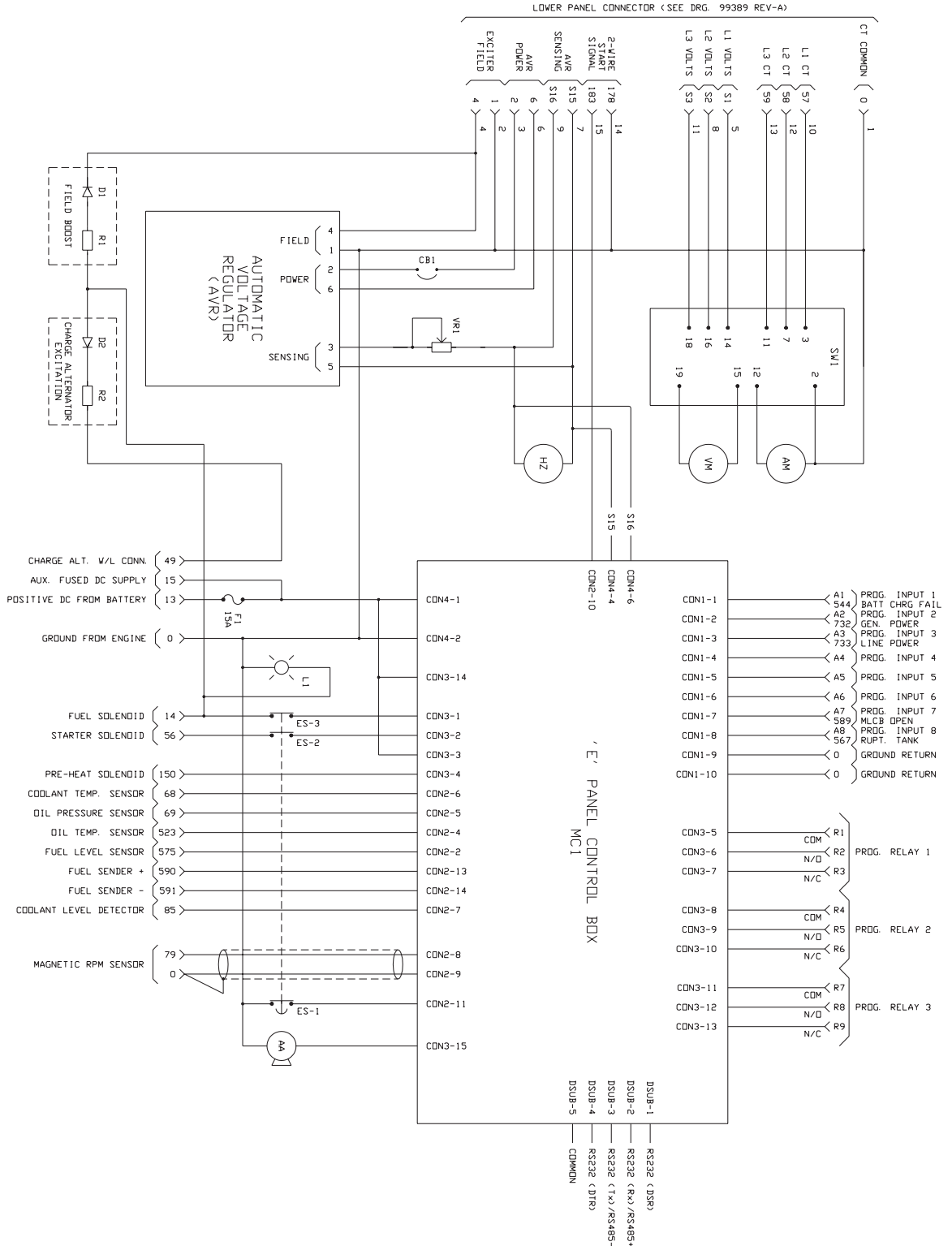



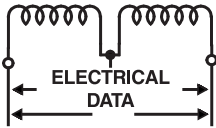

## Section 5 – Electrical Data

### Wiring Diagram (For Use With Generac Alternator) – Drawing No. 0A5502-D

For units manufactured prior to the 2nd quarter of 2000.

Standard diagram. Please refer to the Owner's Manual of the unit for specific details.

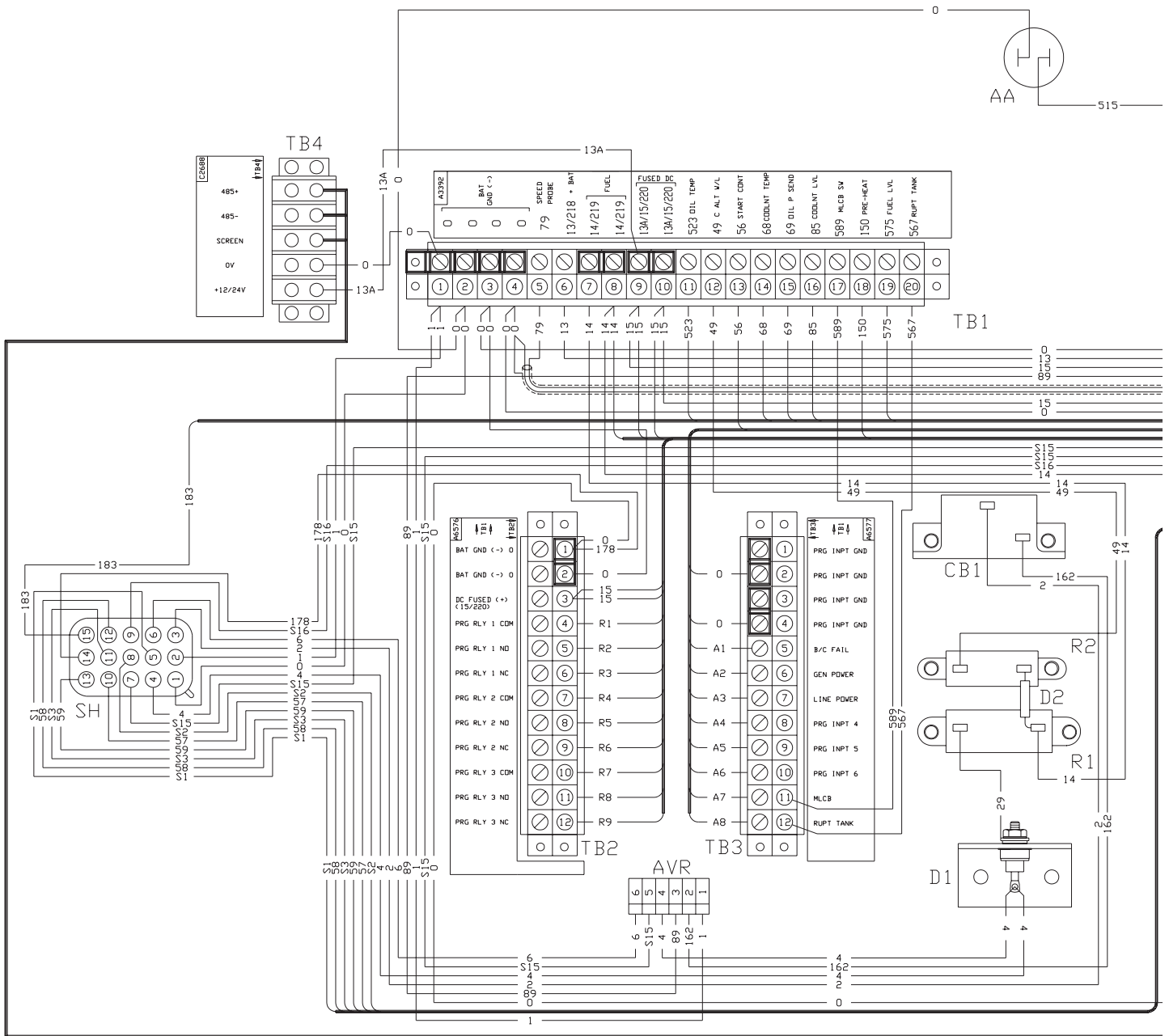





## Section 5 – Electrical Data

### Schematic Diagram (For Use With Marathon Alternator) – Drawing No. 0C8326-B For units manufactured starting the 2nd quarter of 2000.

**Standard diagram. Please refer to the Owner's Manual of the unit for specific details.**

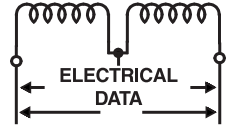

CODE	QTY	PART NO.	DESCRIPTION
AA	1	61286	AUDIBLE ALARM
AM	1	VARIOUS	AMMETER
D3	2	94261E	SURGE SUPPRESSING DIODE
ES	1	98426A	EMERGENCY STOP BUTTON
ES1-3	3	98426C	NORMALLY CLOSED CONTACTS
F1	1	32300	PANEL FUSE (15A)
HZ	1	VARIOUS	FREQUENCY METER
L1	1	70202	PANEL LAMP
MCI	1	A4087	E-PANEL CONTROLLER ASSEMBLY
RR	1	86035	RUN RELAY (70A)
SH	1	56089	SOCKET HOUSING
SW1	1	61945	VOLTTMETER SWITCH
VM	1	VARIOUS	VOLTMETER

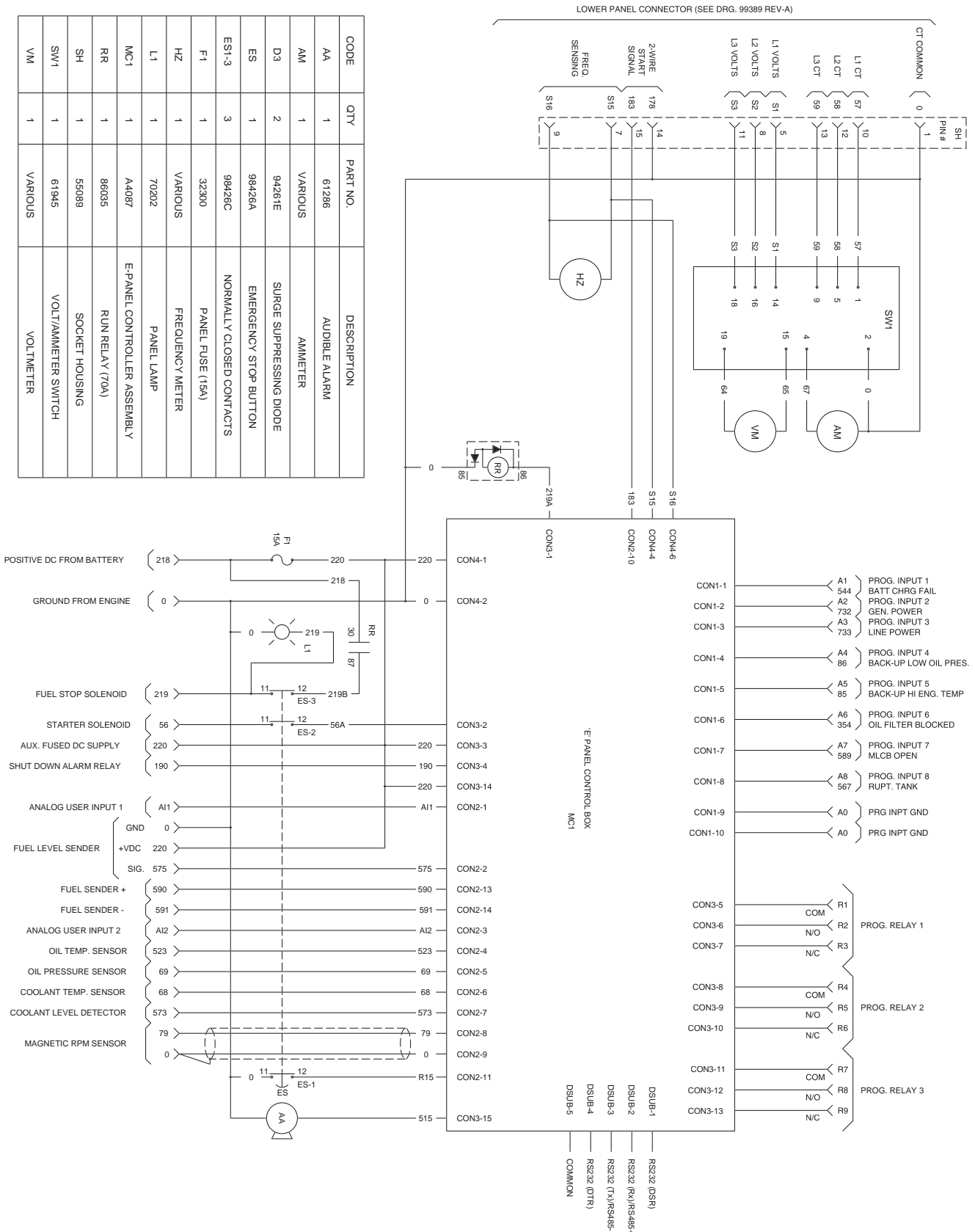

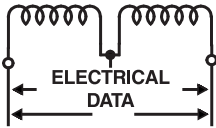

## Section 5 – Electrical Data

### Wiring Diagram (For Use With Marathon Alternator) – Drawing No. 0C1376-D

For units manufactured prior to the 2nd quarter of 2000.

Standard diagram. Please refer to the Owner's Manual of the unit for specific details.

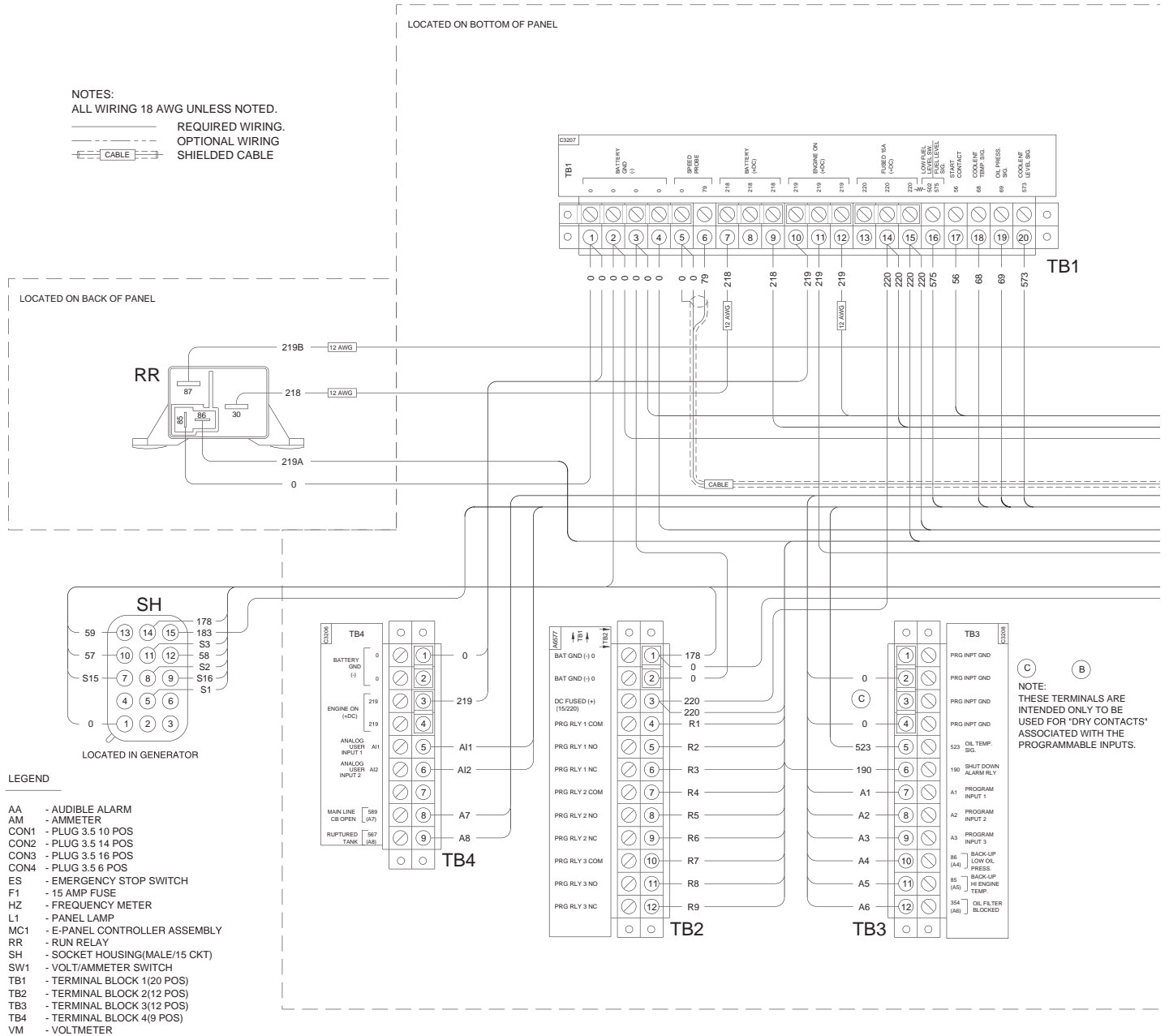

Section 5 – Electrical Data

Wiring Diagram (For Use With Marathon Alternator) – Drawing No. 0C1376-D

For units manufactured prior to the 2nd quarter of 2000.

Standard diagram. Please refer to the Owner's Manual of the unit for specific details.

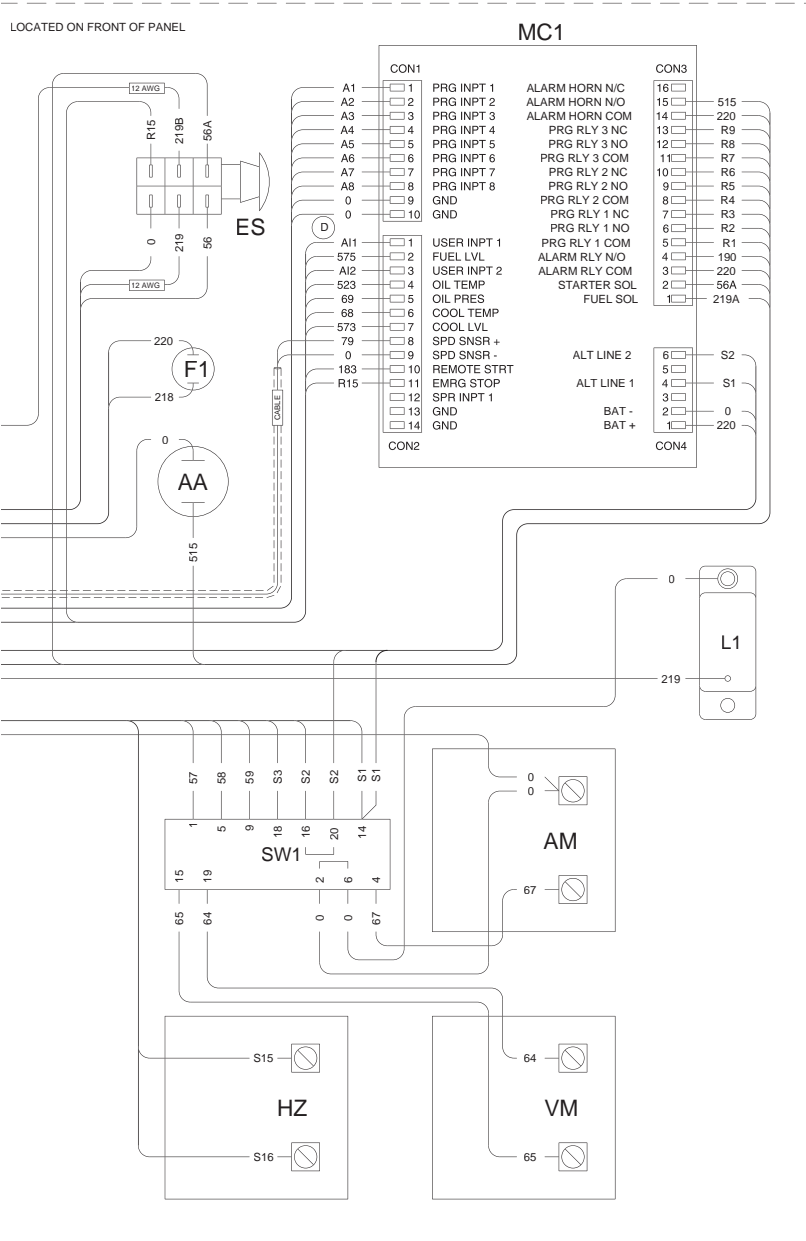
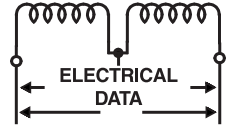

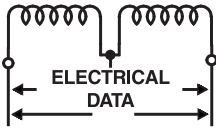

## Section 5 – Electrical Data

### Wiring Diagram (For Use With Marathon Alternator) – Drawing No. 0C8327-C

For units manufactured starting the 2nd quarter of 2000.

Standard diagram. Please refer to the Owner's Manual of the unit for specific details.

LOCATED ON BOTTOM OF PANEL

HARNESS OUT TO FUEL LEVEL SENDER

SIG. — 575  
+VDC — 220  
GND — 0

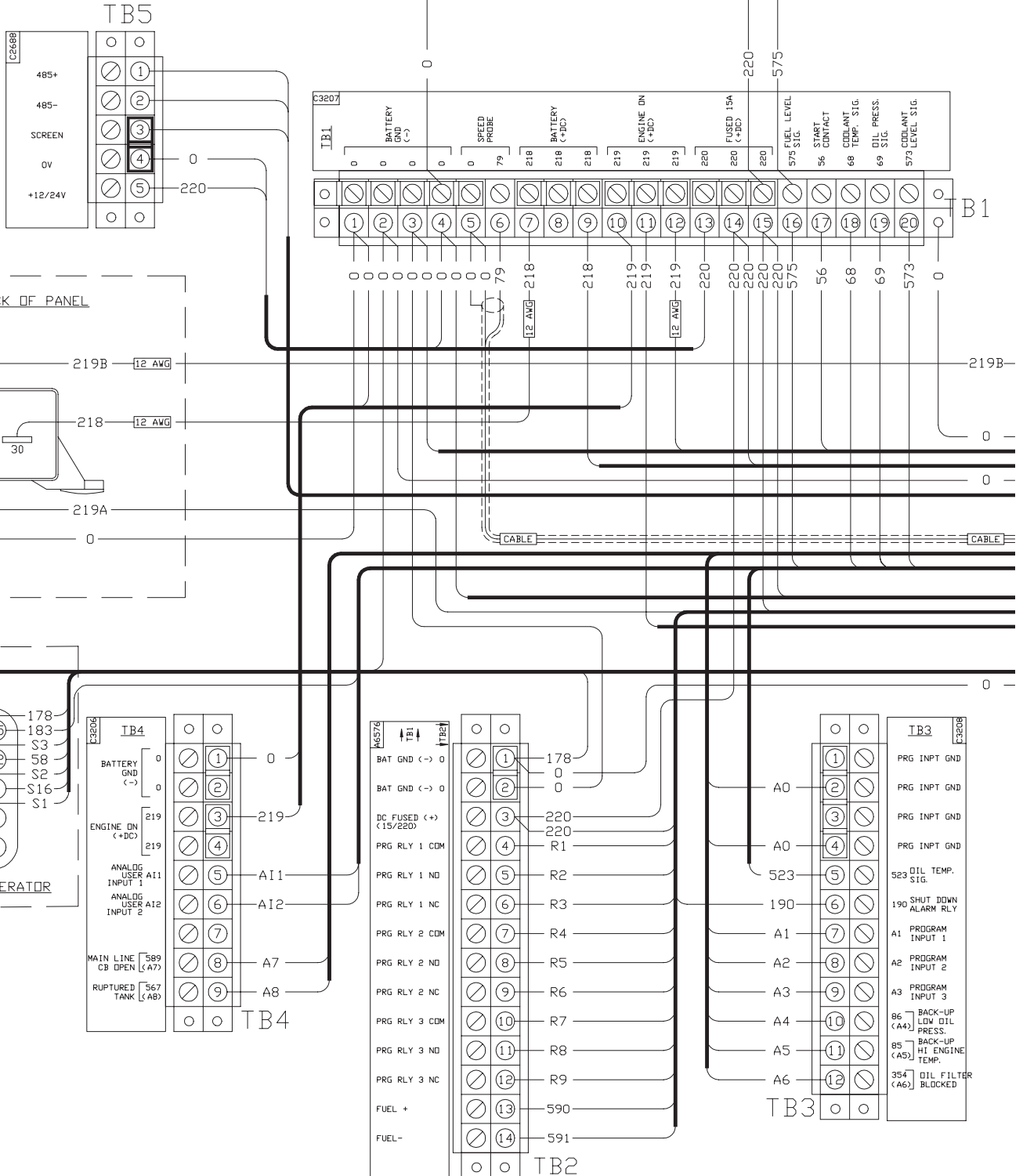

**Section 5 – Electrical Data**

**Wiring Diagram (For Use With Marathon Alternator) – Drawing No. 0C8327-C**

**For units manufactured starting the 2nd quarter of 2000.**

**Standard diagram. Please refer to the Owner's Manual of the unit for specific details.**

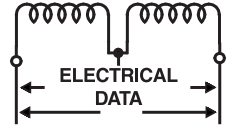

NOTES:  
ALL WIRING 18 AWG UNLESS NOTED

— REQUIRED WIRING  
- - - - - OPTIONAL WIRING  
- - - - - CABLE - - - - - SHIELDED CABLE

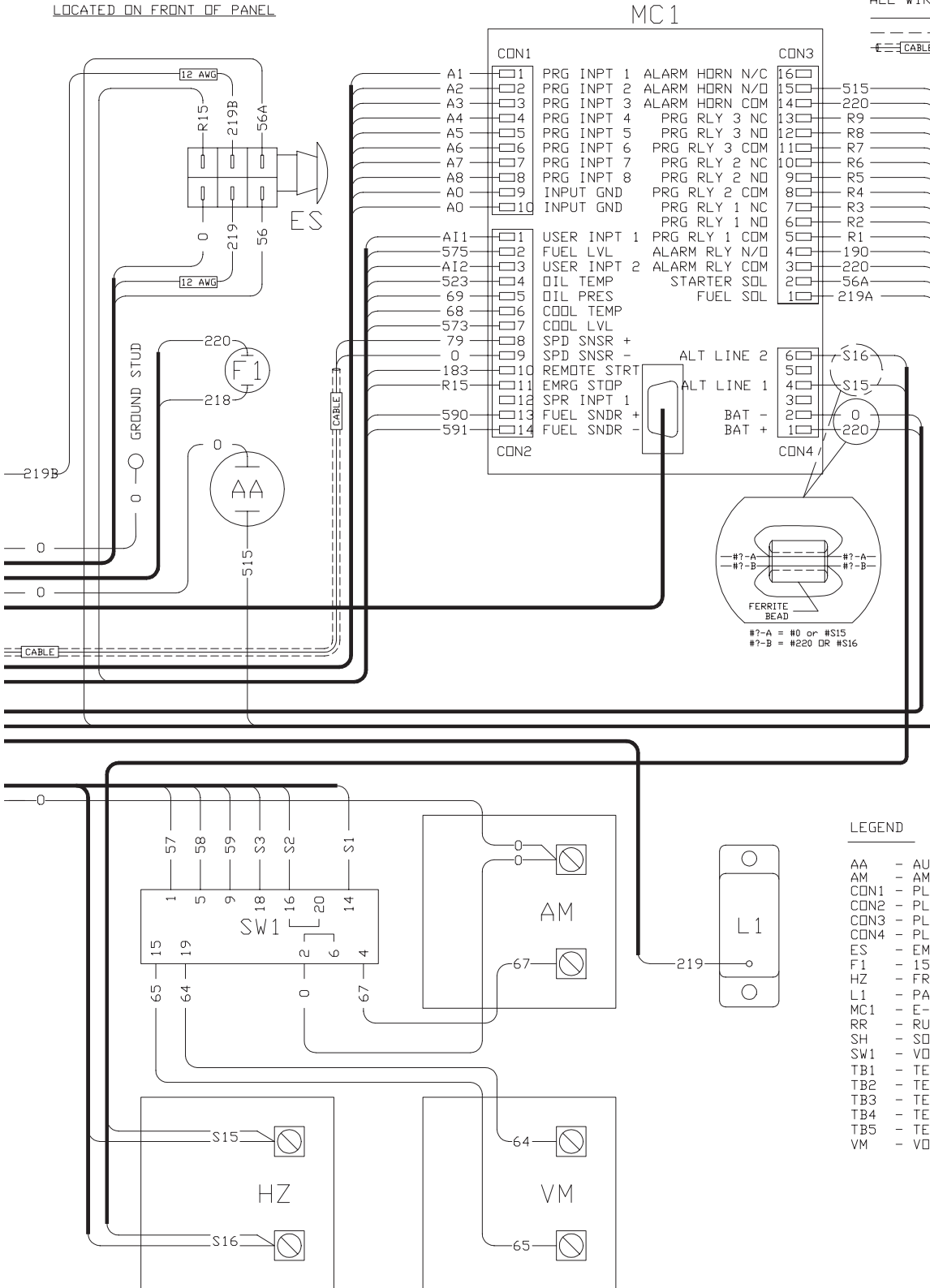

**LEGEND**

- AA - AUDIBLE ALARM
- AM - AMMETER
- CON1 - PLUG 3.5 10 PDS
- CON2 - PLUG 3.5 14 PDS
- CON3 - PLUG 3.5 16 PDS
- CON4 - PLUG 3.5 6 PDS
- ES - EMERGENCY STOP SWITCH
- F1 - 15 AMP FUSE
- HZ - FREQUENCY METER
- L1 - PANEL LAMP
- MC1 - E-PANEL CONTROLLER ASSEMBLY
- RR - RUN RELAY
- SH - SOCKET HOUSING (MALE/15 CKT)
- SW1 - VOLT/AMMETER SWITCH
- TB1 - TERMINAL BLOCK 1 (20 PDS)
- TB2 - TERMINAL BLOCK 2 (12 PDS)
- TB3 - TERMINAL BLOCK 3 (12 PDS)
- TB4 - TERMINAL BLOCK 4 (9 PDS)
- TB5 - TERMINAL BLOCK 5 (5 PDS)
- VM - VOLTMETER



## Section 6 – Exploded Views and Parts Lists

### Control Panel (For Use With Generac Alternator) – Drawing No. 0D2383-J

For units manufactured prior to the 3rd quarter 2002, with a watertight connector.

Standard drawing. Please refer to the Owner's Manual of the unit for specific details.

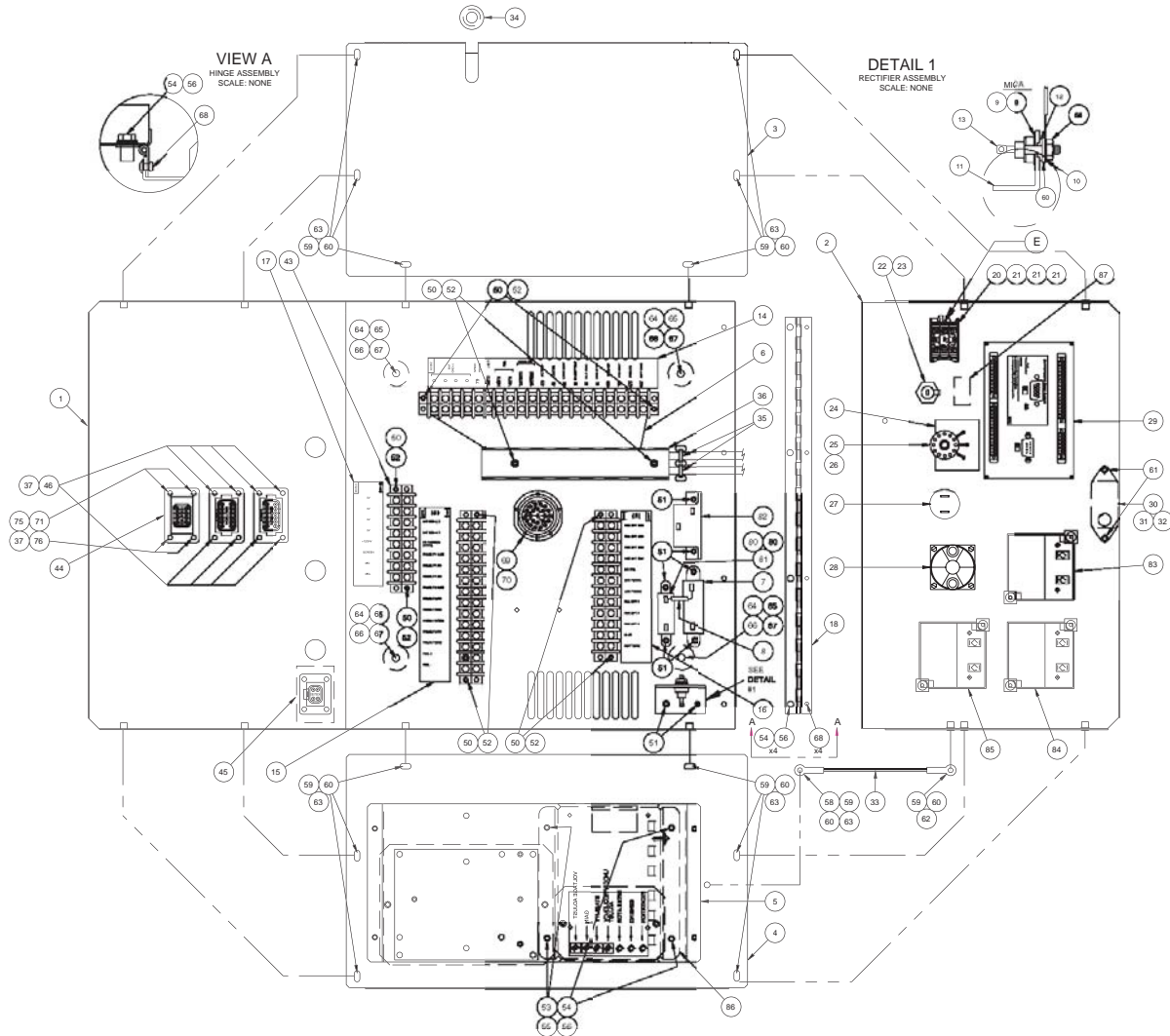

ALL DIRECTLY EXCITED MACHINES	5 OHM 25W
UPTO 100KW WITH 12 OR 24V DC SYSTEMS	P/N: 048352
ALL BRUSHLESS & PME MACHINES	25 OHM 25W
UPTO 100KW WITH 12V DC SYSTEMS	P/N: 057405
ALL BRUSHLESS & PME MACHINES	50 OHM 25W
UPTO 100KW WITH 24V DC SYSTEMS	P/N: 083364
ALL BRUSHLESS & PME MACHINES	75 OHM 25W
OVER 100KW WITH 12 OR 24V DC SYSTEMS	P/N: 086286

ALL DIRECTLY EXCITED MACHINES	7A
19 TO 45KW	P/N: 048467
ALL BRUSHLESS & PME MACHINES	5.5A
19 TO 26KW	P/N: 054450
ALL BRUSHLESS & PME MACHINES	6.0A
21 TO 41KW	P/N: 048505
ALL BRUSHLESS & PME MACHINES	7A
45 TO 100KW	P/N: 048476
ALL BRUSHLESS & PME MACHINES	4.5A
OVER 100KW	P/N: 048476

AMMETER P/N	AMMETER RANGE
070056	0-150A
070057	0-300A
070058	0-400A
070059	0-600A
070060	0-800A
075323	0-1000A
075324	0-1600A
075325	0-2000A
075326	0-3000A
070045	0-200A

VOLT. CODE	VOLTAGE	VOLTAGE METER P/N	VOLTAGE METER RANGE
A	120/240V 1 PHASE	070043	0-300V
D	120/240V 1.3 PHASE	070043	0-300V
G	120/208V 3 PHASE	070043	0-300V
J	120/240V 3 PHASE	070043	0-300V
K	277/480V 3 PHASE	070044	0-600V
M	110/220V 1 PHASE	070043	0-300V
N	115/200V 3 PHASE	070043	0-300V
P	100/200V 3 PHASE	070043	0-300V
R	231/400V 3 PHASE	070044	0-600V
L	600V 3 PHASE	082404	0-750V

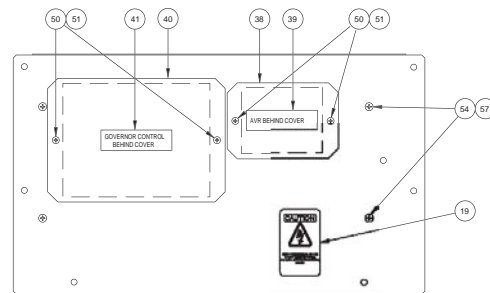

CONTROL PANEL LEFT SIDE

## Section 6 – Exploded Views and Parts Lists

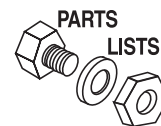

### Control Panel (For Use With Generac Alternator) – Drawing No. 0D2383-J

For units manufactured with a watertight connector.

Standard drawing. Please refer to the Owner's Manual of the unit for specific details.

ITEM	PART NO.	QTY.	DESCRIPTION	ITEM	PART NO.	QTY.	DESCRIPTION
1	0D2370	1	BOTTOM E PANEL W/SEALED CONS	45	0D3471	2	DECAL COVER DEUTSCH (RECT)
2	0A6324	1	PANEL FRNT E W/SLKSCRN				(ELECTRONIC GOVERNOR HARNESS
3	0A6322	1	PANEL RIGHT SIDE E				IF EQUIPPED)
4	0A6321	1	PANEL LEFT SIDE E	46	0C5141	2	CONN DEUTSCH GASKET 8/12POS
5	0E3550	1	CHASSIS, UNIVERSAL				DT
6	0D2382	1	HARNESS E-PANEL W/SEALED CONS	50	022155	14	WASHER LOCK #6
7	044213	1	RES 10R 5% 12W	51	0C2428	14	SCREW TAPTITE PH 6-32 X 1/2 Z/YC
8	025192	1	RECTIFIER MSC 2A 600V 1N5062	52	0C2323	10	SCREW TAPTITE PH 6-32 X 5/8 ZYC
9	070370	2	WASHER MICA .203	53	022471	4	NUT HEX #8-32 STEEL
10	023762	1	WASHER SHAKEPROOF EXT #10 STL	54	022264	8	WASHER LOCK M4
11	055444	1	HEATSINK 13.3L	55	038150	4	WASHER FLAT #8 ZINC
12	030468	1	WASHER STEP NYLON .20	56	036918	8	SCREW PPHM #8-32 X 1/2
13	049939	1	RECTIFIER MSC 12A 600V 1N1206R	57	0A2284	4	SCREW SWAGE 8-32 X 1/2 Z/YC
14	0A3392	1	DECAL TERMINAL BLOCK	58	022158	2	NUT HEX #10-32 STEEL
15	0C8229	1	DCL-E PNL TS#2 (W/FS)	59	022152	14	WASHER LOCK #10
16	0A6577	1	DECAL T STRIP 3 E PNL	60	023897	15	WASHER FLAT #10 ZINC
17	0D3153	1	DECAL T STRIP TB4 W/SEALED CON	61	024469	2	SCREW TAPTITE #10-32 X 3/8 BP
18	0A2273	1	HINGE RAM PANEL	62	033120	1	SCREW HHC #10-32 X 3/8
19	0C1229	1	DECAL CUST CONN BOX	63	033121	13	SCREW HHC #10-32 X 1/2
20	0E2693A	1	SWITCH MUSHRM HEAD/ARROWS	64	022507	4	SCREW HHC 1/4-20 X 1/2 G5
			40MM	65	022097	4	WASHER LOCK M6-1/4
21	0E2693C	3	CONTACT BLOCK D5-3 X 01 W/2 1417	66	022473	4	WASHER FLAT 1/4 ZINC
22	032300	1	HOLDER FUSE	67	040479	4	VIB MNT 1.0 X 1.0 X 1/4-20
23	022676	1	FUSE 15A X AGC15	68	036261	4	RIVET POP .125 X .129-.133/#30
24	055349	1	INSULATOR	69	0C8243	1	WASHER LOCK HDPDEUTSCH
25	071361	1	POT 5K 10% 2.25W PNL	70	0C8244	1	NUT HDP DEUTSCH
26	050123	1	KNOB PLASTIC .25 SHAFT				
27	061286	1	SOUNALERT BUZZER	ADDITIONAL PARTS (BASE TANK UNITS)			
28	061945	1	SWITCH SELECTOR 6A AMP/V	71	074908	4	SCREW HHTT M-5-0. 8 X 10 BP
29	0A4087	1	MASTER CTRL BOX E-PNL	75	0D3306	1	HARNESS BASETANK FOR E-PANEL
30	0E3703	1	LIGHT PANEL WITH LUG	76	0C5141	1	CONN DEUTSCH GASKET 8/12 POS
31	0C8481	1	BULB-PANEL LIGHT-12V				DT
	083288	1	LIGHT 28VDC .17A MIN BAYNT MNT	PANEL SPECIAL PARTS			
32	070082	1	BLOCKER LIGHT	80	064733	2	BRACKET RESISTOR MNTNG FOR
33	0A2275	1	DOOR-STOP RAM PANEL				25W
34	030809	1	GROMMET 11/16 X 1/8 X 7/16	81	SEE TABLE A	1	RESISTOR #2
35	028739	2	TIE WRAP 3.9" X .10" NAT'L UL	82	SEE TABLE B	1	FIELD CIRCUIT BREAKER
36	0A2400A	1	TRUNKING 180MM	83	SEE TABLE C	1	AMMETER
37	074908	8	SCREW HHTT M5-0.8 X 10 BP	84	SEE TABLE D	1	VOLTMETER AC
38	0A1441B	1	COVER PLATE, AVR	85	070042	1	METER FREQUENCY 55-65HZ
39	0C1127	1	DECAL AVR COVER		070042A	1	FREQUENCY METER 240V 45-55HZ
40	0A1441C	1	COVER PLATE EGOV	86	067680	1	ASSY VOLTAGE REGULATOR 60HZ
41	0A3394	1	DECAL ELEC GOVERNOR		092952	1	ASSY VOLTAGE REGULATOR 50HZ
42	0A5705	REF.	FUSE 5A X LTTL215005 (NOT SHOWN)	87	0E3783	1	DECAL WARNING REMOVE FUSE
43	0D3243	1	CBL ASSY-RS485 E PNL W/SEALED				
44	0D3471	2	DECAL COVER DEUTSCH (RECT)				

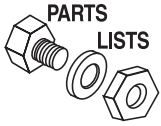

## Section 6 – Exploded Views and Parts Lists

### Control Panel (For Use With Marathon Alternator) – Drawing No. 0D4267B-H

For units manufactured with a watertight connector.

Standard drawing. Please refer to the Owner's Manual of the unit for specific details.

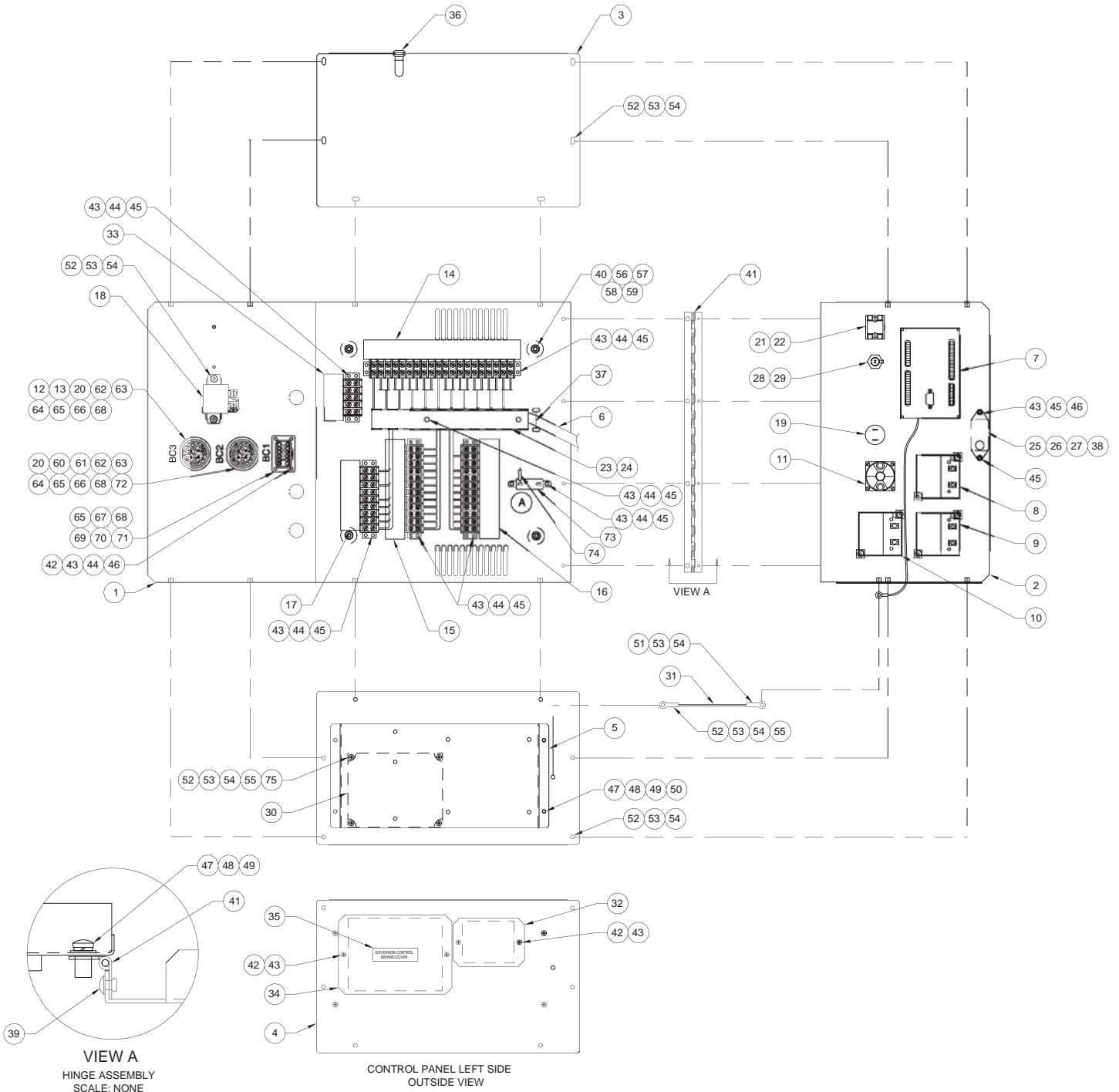

## Section 6 – Exploded Views and Parts Lists

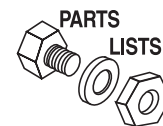

### Control Panel (For Use With Marathon Alternator) – Drawing No. 0D4267B-H

For units manufactured with a watertight connector

Standard drawing. Please refer to the Owner's Manual of the unit for specific details.

ITEM	PART NO.	QTY.	DESCRIPTION	ITEM	PART NO.	QTY.	DESCRIPTION
1	0D4650	1	"E" PANEL BOTTOM/BACK W/TCONN	35	0A3394	1	DECAL ELEC GOVERNOR
2	0C3872	1	FRONT E PANEL 400KW	36	030809	1	GROMMET 11/16 X 1/8 X 7/16
3	0A6322	1	PANEL RIGHT SIDE E	37	029333	1	TIE WRAP 7.4" X .19" NATL UL
4	0A6321	1	PANEL LEFT SIDE E	38	074130	1	LUG DIS SN-PLG I-T 22-18 CU
5	0A6323	1	CHASSIS AVR & E-GOV	39	036261	4	RIVET POP .125 X .275 AL
6	0D4267D	1	HARNESS "E" CONTROL PNL WT CON	40	040479	4	MOUNT VIBR 1.0 X 1.0 X 1/4-20
7	0A4087	1	MSTR CTRL BOX E-PNL	41	0A2273	1	HINGE RAM PANEL
8	070060	1	AMMETER 0-800	42	036901	8	SCREW PPHM #6-32 X 3/8
	0A6798A	1	AMMETER 0-1600	43	022155	17	WASHER LOCK #6
	0A6798B	1	AMMETER 0-2000	44	022985	18	WASHER FLAT #6 ZINC
9	070043	1	VOLTMETER 0-300V	45	0C2428	16	SCREW PHTT #6-32 X 1/2 ZYC
	070044	1	VOLTMETER 0-600V	46	022188	10	NUT HEX #6-32 STEEL
	082404	1	VOLTMETER 0-750V	47	036918	8	SCREW PPHM #8-32 X 1/2
10	0C1212C	1	FREQUENCY METER 120V 55-65HZ	48	022264	8	WASHER LOCK M4
	0C1212B	1	FREQUENCY METER 277V 55-65HZ	49	038150	8	WASHER FLAT #8 ZINC
	0C1212A	1	FREQUENCY METER 346V 55-65HZ	50	022471	4	NUT HEX #8-32 STEEL
	070042A	1	FREQUENCY METER 240V 45-55HZ	51	033120	1	SCREW HHC #10-32 X 3/8
11	074386	1	SWITCH SELECT VOLT/AMP 3PH	52	033121	13	SCREW HHC #10-32 X 1/2
12	0D4654	1	CONN DEUTSCH PLUG 21 PIN	53	022152	16	WASHER LOCK #10
13	0D4655	1	CONN DEUTSCH RECEPT 21 PIN	54	023897	16	WASHER FLAT #10 ZINC
14	0C3207	1	DECAL T STRIP 1 E PNL	55	022158	3	NUT HEX #10-32 STEEL
15	0A6576	1	DECAL T STRIP 2 E PNL	56	022287	4	SCREW HHC 1/4-20 X 3/4 G5
16	0C3208	1	DECAL T STRIP 3 E PNL	57	022097	4	WASHER LOCK M6-1/4
17	0C3206	1	DECAL T STRIP 4 E PNL	58	022473	4	WASHER FLAT 1/4-M6 ZINC
18	0C4110	1	RELAY 24V 50A W/DIODE	59	047246	4	FLAT WASHER SPECIAL
19	061286	1	SOUNALERT BUZZER	60	0C8237	1	CONN DTCH HDP24-21PN
20	0C8243	2	WASHER LOCK HDP DEUTSCH	61	0D4655	1	CONN DEUTSCH RECEPT 21 PIN
21	0E2693A	1	SWITCH MUSHRM HEAD/ARROWS 40MM	62	0C8241	3	PIN SIZE 12 DEUTSCH
22	0E2693C	3	CONTACT BLOCK D5-3 X 01 W/2 1417	63	0C8242	4	SOCKET SZ 12 DEUTSCH
23	091472	1	DUCT WIRING 1 X 1.5 6 FT (9.5")	64	0C8244	2	NUT HDP DEUTSCH
24	091472A	1	COVER WIRE DUCT 1 IN (9.5")	65	0C5144	1	5 CONN DEUTSCH PIN #16-18 BLKHD
25	0E3703	1	LIGHT PANEL WITH LUG	66	0D4651	1	5 PIN SIZE 14-16 1060-14-0122
26	083288	1	LIGHT 28VDC .17A MIN BAYNT MNT	67	0C5137	1	CONN DEUTSCH RECEPT BK/FLN
27	070082	1	BLOCKER LIGHT	68	0C5141	1	CONN DEUTSCH GASKET BLKHD
28	032300	1	HOLDER FUSE	69	0C5142	1	CONN DEUTSCH RECEPT WDG E BLKHD
29	022676	1	FUSE 15A X AGC15	70	0C5145	1	CONN DEUTSCH PLUG BLKHD BLK
30	0D4167	1	CONTROLLER B-C#:DPG-2107 (DSL)	71	0C5148	1	CONN DEUTSCH WEDGE LOCK 12-WAY
31	0A2275	1	DOOR-STOP RAM PANEL	72	0C5185	6	CONN DEUTSCH SOCKET #16-20 DTM
32	0A1441B	1	COVER PLATE AVR	73	044213	1	RES 10R 5% 12W
33	0C2688	1	DECAL TERM STRIP TB4	74	025192	1	RECTIFIER MSC 2A 600V 1N5062
34	0A1441C	1	COVER PLATE E GOV	75	036904	4	SCREW PPHM #6-32 X 3/4

## Section 6 – Exploded Views and Parts Lists

### Control Panel (For Use With Generac Alternator) – Drawing No. 0D8764-H

For units manufactured starting the 3rd quarter 2002, with a watertight connector.

Standard drawing. Please refer to the Owner's Manual of the unit for specific details.

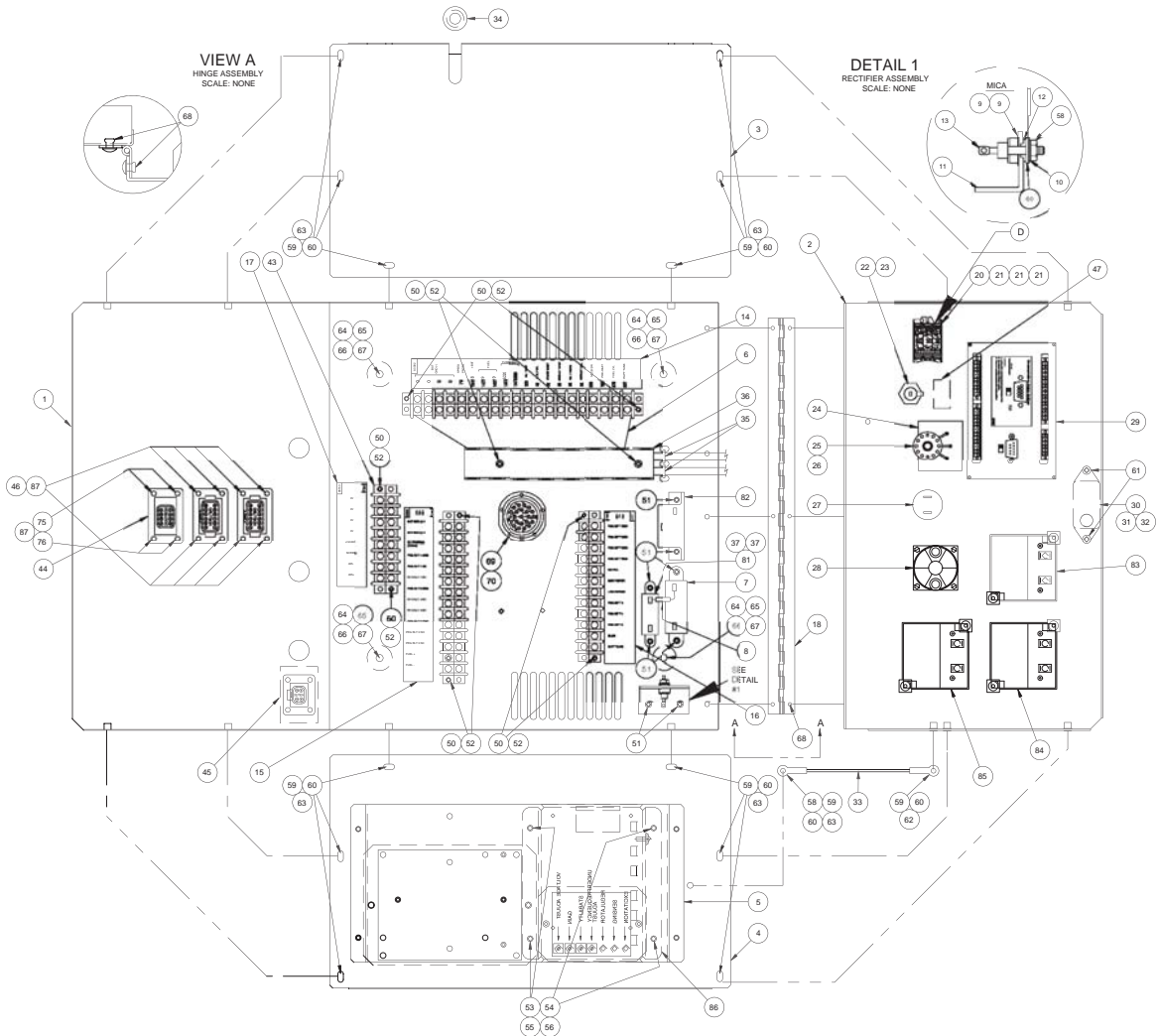

**TABLE A-FIELD BOOST RESISTOR DATA**

ALL DIRECTLY EXCITED MACHINES	5 OHM 25W
UPTO 100KW WITH 12 OR 24V DC SYSTEMS	P/N: 048352
ALL BRUSHLESS & PME MACHINES	25 OHM 25W
UPTO 100KW WITH 12V DC SYSTEMS	P/N: 057405
ALL BRUSHLESS & PME MACHINES	50 OHM 25W
UPTO 100KW WITH 24V DC SYSTEMS	P/N: 083364
ALL BRUSHLESS & PME MACHINES	75 OHM 25W
OVER 100KW WITH 12 OR 24V DC SYSTEMS	P/N: 086266

**TABLE B-AVR POWER(DPE) CIRCUIT BREAKER DATA**

ALL DIRECTLY EXCITED MACHINES	7A
19 TO 45KW	P/N: 048467
ALL BRUSHLESS & PME MACHINES	5.5A
19 TO 26KW	P/N: 054450
ALL BRUSHLESS & PME MACHINES	6.0A
21 TO 41KW	P/N: 048505
ALL BRUSHLESS & PME MACHINES	7A
45 TO 100KW	P/N: 048476
ALL BRUSHLESS & PME MACHINES	4.5A
OVER 100KW	P/N: 048476

**TABLE C-AMMETER**

AMMETER P/N:	AMMETER RANGE
070056	0-150A
070057	0-300A
070058	0-400A
070059	0-600A
070060	0-800A
075323	0-1000A
075324	0-1600A
075325	0-2000A
075326	0-3000A
070045	0-200A

**TABLE D: VOLTAGE METER**

VOLT. CODE	VOLTAGE	VOLTAGE METER P/N:	VOLTAGE METER RANGE
A	120/240V 1 PHASE	070043	0-300V
D	120/240V 1.3 PHASE	070043	0-300V
G	120/208V 3 PHASE	070043	0-300V
J	120/240V 3 PHASE	070043	0-300V
K	277/480V 3 PHASE	070044	0-600V
M	110/220V 1 PHASE	070043	0-300V
N	115/200V 3 PHASE	070043	0-300V
P	100/200V 3 PHASE	070043	0-300V
R	231/400V 3 PHASE	070044	0-600V
L	600V 3 PHASE	082404	0-750V

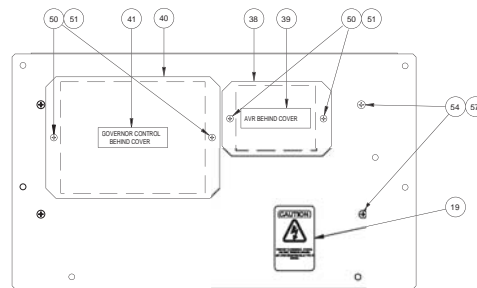

**CONTROL PANEL LEFT SIDE**

## Section 6 – Exploded Views and Parts Lists

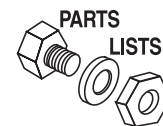

**Control Panel (For Use With Generac Alternator) – Drawing No. OD8764-H**  
**For units manufactured starting the 3rd quarter 2002, with a watertight connector.**  
**Standard drawing. Please refer to the Owner's Manual of the unit for specific details.**

ITEM	PART NO.	QTY.	DESCRIPTION	ITEM	PART NO.	QTY.	DESCRIPTION
1	OD8756	1	BOTTOM, E PANEL W/SEALED CONS	43	OD3243	1	CBL ASSY-RS485 E PNL W/SEALED
2	OD8754	1	"E" PANEL FRONT W/SILK SCREEN	44	OD3471	2	DECAL COVER DEUTSCH (RECT)
3	OA6322	1	PANEL RIGHT SIDE E	45	OD3471	2	DECAL COVER DEUTSCH (RECT)
4	OA6321	1	PANEL LEFT SIDE E				(ELECTRONIC GOVERNOR HARNESS
5	OE3550	1	CHASSIS, UNIVERSAL				IF EQUIPPED)
6	OD2382	1	HARNESS E-PANEL W/SEALED CONS	46	OC5141	2	CONN DEUTSCH GASKET 8/12POS
7	044213	1	RES 10R 5% 12W				DT
8	025192	1	RECTIFIER MSC 2A 600V 1N5062	47	OE3783	1	DECAL, WARNING REMOVE FUSE
9	070370	2	WASHER MICA .203	50	022155	14	WASHER LOCK #6
10	023762	1	WASHER SHAKEPROOF EXT #10 STL	51	OC2428	14	SCREW TAPTITE PH 6-32X1/2 Z/YC
11	055444	1	HEATSINK 13.3L	52	OC2323	10	SCREW TAPTITE PH 6-32X5/8 ZYC
12	030468	1	WASHER STEP NYLON .20	53	022471	4	NUT HEX #8-32 STEEL
13	049939	1	RECTIFIER MSC 12A 600V 1N1206R	54	022264	8	WASHER LOCK M4
14	OA3392	1	DECAL TERMINAL BLOCK	55	038150	4	WASHER FLAT #8 ZINC
15	OC8229	1	DCL-E PNL TS#2 (W/FS)	56	036918	4	SCREW PPHM #8-32 X 1/2
16	OA6577	1	DECAL T STRIP 3 E PNL	57	OA2284	4	SCREW SWAGE 8-32 X 1/2 Z/YC
17	OD3153	1	DECAL T STRIP TB4 W/SEALED CON	58	022158	2	NUT HEX #10-32 STEEL
18	OD6947	1	HINGE CONTINUOUS	59	022152	14	WASHER LOCK #10
19	OC1229	1	DECAL CUST CONN BOX	60	023897	15	WASHER FLAT #10 ZINC
20	OE2693A	1	SWITCH MUSHRM HEAD/ARROWS	61	024469	2	SCREW TAPTITE #10-32 X 3/8 BP
			40MM	62	033120	1	SCREW HHC #10-32 X 3/8
21	OE2693C	3	CONTACT BLOCK D5-3 X 01 W/2 1417	63	033121	13	SCREW HHC #10-32 X 1/2
22	032300	1	HOLDER FUSE	64	022507	4	SCREW HHC 1/4-20 X 1/2 G5
23	022676	1	FUSE 15A X AGC15	65	022097	4	WASHER LOCK M6-1/4
24	055349	1	INSULATOR	66	022473	4	WASHER FLAT 1/4 ZINC
25	071361	1	POT 5K 10% 2.25W PNL	67	040479	4	VIB MNT 1.0 X 1.0 X 1/4-20
26	050123	1	KNOB PLASTIC .25 SHAFT	68	036261	6	RIVET POP .125 X .129-.133/#30
27	061286	1	SOUNALERT BUZZER	69	OC8243	1	WASHER LOCK HDPDEUTSCH
28	061945	1	SWITCH SELECTOR 6A AMP/V	70	OC8244	1	NUT, HDP DEUTSCH
29	OA4087	1	MASTER CTRL BOX E-PNL				
30	OE3703	1	LIGHT PANEL WITH LUG	ADDITIONAL PARTS (BASE TANK UNITS)			
31	OC8481	1	BULB-PANEL LIGHT-12V	75	OD3306	1	HARNESS BASETANK FOR E-PANEL
	083288	1	LIGHT 28VDC .17A MIN BAYNT MNT	76	OC5141	1	CONN DEUTSCH GASKET 8/12 POS
32	070082	1	BLOCKER LIGHT				DT
33	OA2275	1	DOOR-STOP RAM PANEL	PANEL SPECIAL PARTS			
34	030809	1	GROMMET 11/16 X 1/8 X 7/16	81	SEE TABLE A	1	RESISTOR #2
35	028739	2	TIE WRAP 3.9" X .10" NAT'L UL	82	SEE TABLE B	1	FIELD CIRCUIT BREAKER
36	OA2400A	1	TRUNKING 180MM	83	SEE TABLE C	1	AMMETER
37	064733	2	RES MTG BRACKET	84	SEE TABLE D	1	VOLTMETER AC
38	OA1441B	1	COVER PLATE, AVR	85	070042	1	METER FREQUENCY 55-65HZ
39	OC1127	1	DECAL AVR COVER		070042A	1	FREQUENCY METER 240V 45-55HZ
40	OA1441C	1	COVER PLATE EGOV	86	067680	1	ASSY VOLTAGE REGULATOR 60HZ
41	OA3394	1	DECAL ELEC GOVERNOR		092952	1	ASSY VOLTAGE REGULATOR 50HZ
42	OA5705	REF.	FUSE 5A X LTTL215005 (NOT SHOWN)	87	074908	12	SCREW HHTT M5-0.8 X 10 BP



## Section 6 – Exploded Views and Parts Lists

### Control Panel (For Use With Generac Alternator) – Drawing No. 0D8765-G

For units manufactured starting the 3rd quarter of 2002.

Standard drawing. Please refer to the Owner's Manual of the unit for specific details.

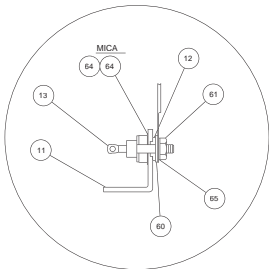
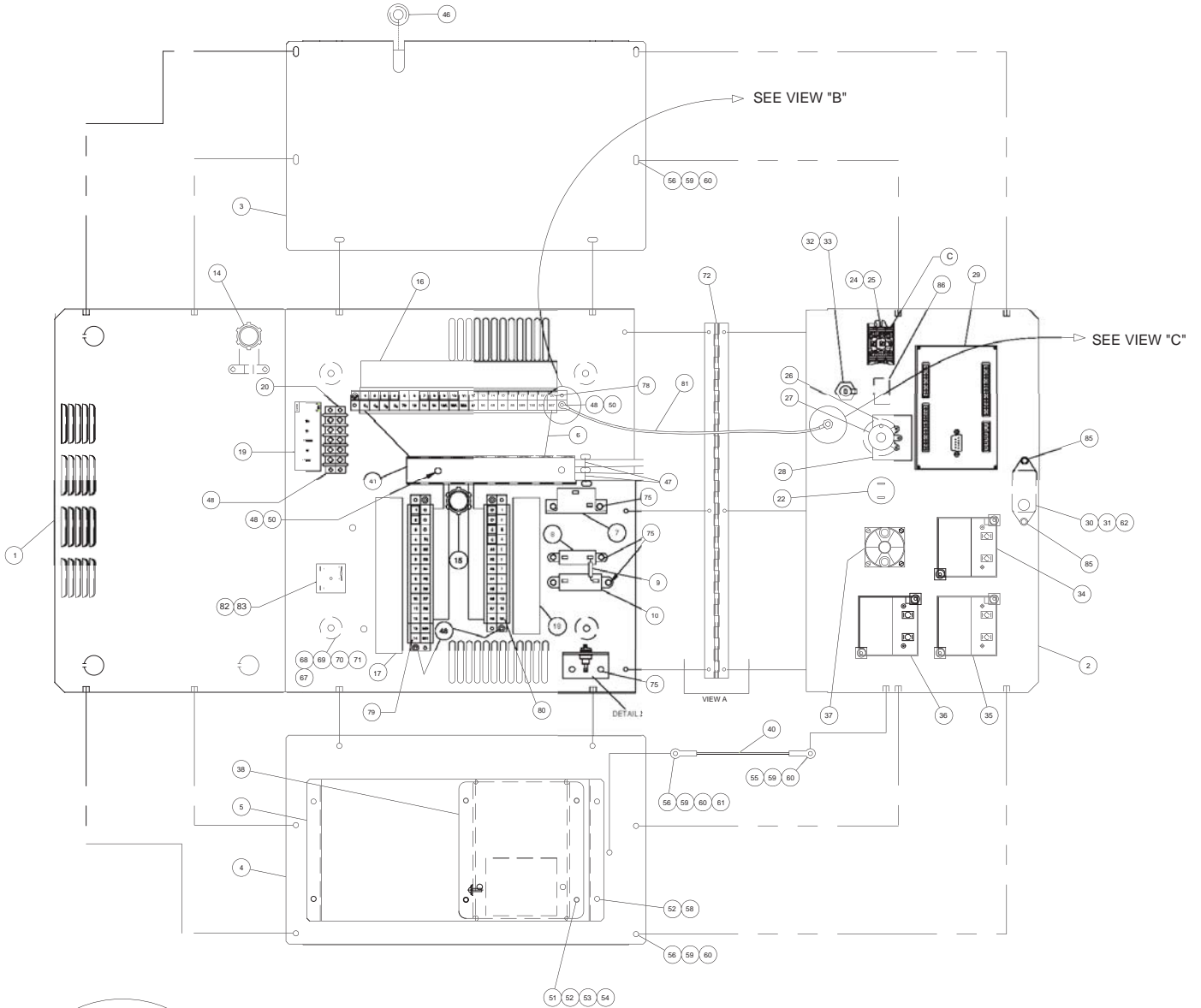

**DETAIL 2**  
RECTIFIER ASSEMBLY  
SCALE: NONE

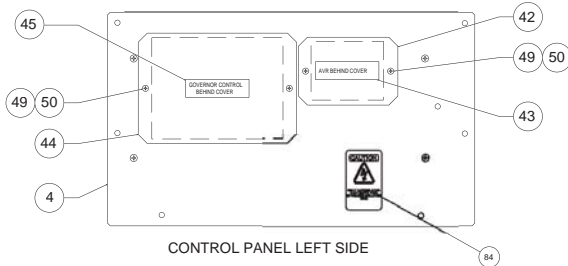

**CONTROL PANEL LEFT SIDE**

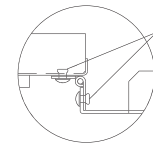

**VIEW A**  
HINGE ASSEMBLY  
SCALE: NONE

SLOT #	WIRE #
1	0
2	1
3	2
4	4
5	51
6	6
7	S15
8	S2
9	S16
10	57
11	S3
12	S8
13	S9
14	178
15	183

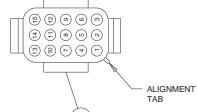

**DETAIL 1**  
WIRE NUMBERS/LOCATIONS  
FOR LOWER PANEL  
HOUSING SOCKET  
SCALE: NONE

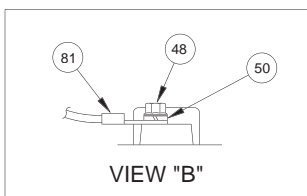

**VIEW "B"**

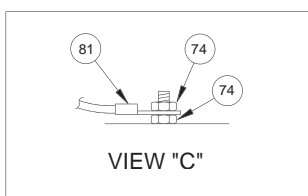

**VIEW "C"**

TABLE A-FIELD BOOST RESISTOR DATA	
ALL DIRECTLY EXCITED MACHINES	5 OHM 25W
1PTO 100KW WITH 12 OR 24V DC SYSTEMS	P/N: 045352
ALL BRUSHLESS & PNE MACHINES	25 OHM 25W
1PTO 100KW WITH 12V DC SYSTEMS	P/N: 052405
ALL BRUSHLESS & PNE MACHINES	50 OHM 25W
1PTO 100KW WITH 24V DC SYSTEMS	P/N: 053364
ALL BRUSHLESS & PNE MACHINES	75 OHM 25W
OVER 100KW WITH 12 OR 24V DC SYSTEMS	P/N: 050266

TABLE B-AVR POWER(DPE) CIRCUIT BREAKER DATA	
ALL DIRECTLY EXCITED MACHINES	7A
19 TO 20KW	P/N: 048467
ALL BRUSHLESS & PNE MACHINES	5.0A
19 TO 20KW	P/N: 054450
ALL BRUSHLESS & PNE MACHINES	6.0A
21 TO 41KW	P/N: 045505
ALL BRUSHLESS & PNE MACHINES	4.0A
45 TO 100KW	P/N: 048476
ALL BRUSHLESS & PNE MACHINES	4.0A
OVER 100KW	P/N: 048476

## Section 6 – Exploded Views and Parts Lists

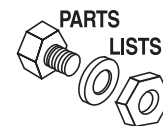

### Control Panel (For Use With Generac Alternator) – Drawing No. 0D8765-G

For units manufactured starting the 3rd quarter of 2002.

Standard drawing. Please refer to the Owner's Manual of the unit for specific details.

ITEM	PART NO.	QTY.	DESCRIPTION	ITEM	PART NO.	QTY.	DESCRIPTION
1	0D8759	1	PANEL BOTTOM/BACK (E-PANEL)	37	061945	1	SWITCH 6A AMP/V SELECTOR
2	0D8754	1	"E" PANEL FRONT W/SILK SCREEN	38	067680	1	ASSY VOLTAGE REGULATOR 60HZ
3	0A6322	1	CONTROL PANEL RIGHT SIDE		092952	1	ASSY VOLTAGE REGULATOR 50HZ
4	0A6321	1	CONTROL PANEL LEFT SIDE	40	0A2275	1	DOOR-STOP RAM PANEL
5	0E3550	1	CHASSIS UNIVERSAL	41	0A2400A	1	TRUNKING 180MM
6	0C8320	1	HARNESS E PNL. WAUK (W/FS)	42	0A1441B	1	COVER PLATE AVR
7	SEE TABLE B	1	CIRCUIT BREAKER	43	0C1127	1	DECAL AVR COVER
8	044213	1	RESIST MISC 10R X 12W	44	0A1441C	1	COVER PLATE E-GOV
9	025192	1	RECTIFIER MSC 2A 600V 1N5062	45	0A3394	1	DECAL E-GOV COVER
10	SEE TABLE A	1	RESISTOR 2	46	030809	1	GROMMET 11/16 X 1/8 X 7/16
11	055444	1	HEAT SINK	47	028739	2	TIE WRAP 4" WHITE
12	030468	1	WASHER STEP NYLON .20	48	0C2323	10	SCREW PHM SWAGE 6-32 X 5/8 Z/YC
13	049939	1	RECTIFIER MSC 12A 600V 1N1206R	49	036901	4	SCREW PPHM #6-32 X 3/8
14	039271	1	FITTING 90 DEGREE 3/4	50	022155	7	WASHER LOCK #6
15	034616	1	FITTING STRAIGHT 3/4	51	036918	8	SCREW PPHM #8-32 X 1/2
16	0A3392	1	DECAL TERMINAL STRIP	52	022264	8	WASHER LOCK M4
17	0C8229	1	DECAL E PNL TS#2 (W/FS)	53	038150	4	WASHER FLAT #8 ZINC
18	0A6577	1	DECAL TERMINAL STRIP TB3	54	022471	4	NUT HEX #8-32 STEEL
19	0C2688	1	DECAL TERMINAL STRIP TB4	55	033120	1	SCREW HHM 10-32 X 3/8
20	048850	REF.	BLOCK TERM 20A 5 X 6 X 1100V	56	033121	9	SCREW HHM 10-32 X 1/2
22	061286	1	AUDIBLE ALARM	58	0A2284	4	SCREW SWAGE 8-32 X 1/2 Z/YC
23	055089	1	CONN ELEC AMP M-N-L 15PLUG PNL	59	022152	10	WASHER LOCK #10
24	0E2693A	1	SWITCH MUSHRM HEAD/ARROWS 40MM	60	023897	11	WASHER FLAT #10 ZINC
25	0E2693C	3	CONTACT BLOCK D5-3 X 01 W/2 1417	61	022158	2	NUT HEX #10-32 STEEL
26	071361	1	POTENTIOMETER PNL 5K +/-10% 2.25W	62	074130	1	LUG DIS SN-PLG I-T 22-18 CU
27	050123	1	KNOB PLASTIC .25 SHAFT	63	036261	6	RIVET POP .125 X .129-.133/#30
28	055349	1	INSULATOR	64	070370	2	WASHER MICA .203
29	0A4087	1	MASTER CONTROL BOX	65	023762	1	WASHER SHAKEPROOF EXT #10 STL
30	0C8481	REF.	BULB-PANEL LIGHT-12V	67	040479	4	MOUNT VIBR 1.0 X 1.0 X 1/4-20
	0E3703	REF.	LIGHT PANEL WITH LUG	68	022287	4	SCREW HHC 1/4-20 X 3/4 G5
	083288	REF.	LIGHT 28VDC .17A MIN BAYNT MNT	69	022097	4	WASHER LOCK M6-1/4
31	070082	1	LIGHT BLOCKER	70	022473	4	WASHER FLAT M6-1/4 ZINC
32	032300	1	FUSE HOLDER	71	047246	4	WASHER FLAT 1/4 SPECIAL
33	022676	1	FUSE 15A X AGC15	72	0D6947	1	HINGE CONTINUOUS
34	070054	1	AMMETER AC 0-50	74	022188	2	NUT HEX #6-32 STEEL
	070055	1	AMMETER AC 0-100	75	0C2428	8	SCREW TAPTITE PH #6-32 X 1/2 ZYC
	070056	1	AMMETER AC 0-150	*	0A5705	1	FUSE 5A X LTTL215005 HLDRA4017 (NOT SHOWN)
	070057	1	AMMETER AC 0-300	78	057335	REF.	BLOCK TERM 20A 20 X 6 X 1100V
	070058	1	AMMETER AC 0-400	79	0C4167	REF.	BLOCK TERM 20A 14 X 6 X 1100V
	070059	1	AMMETER AC 0-600	80	055911	REF.	BLOCK TERM 20A 12 X 6 X 1100V
	070060	1	AMMETER AC 0-800	81	0441140156	REF.	WIRE ASSEMBLY
	075323	1	AMMETER AC 0-1000	82	084717	1	ASSY TIME DELAY (13.3L GAS ONLY)
	075324	1	AMMETER AC 0-1600	83	036908	1	SCREW PPHM #6-32 X 1-1/4 (13.3L GAS ONLY)
	075325	1	AMMETER AC 0-2000	84	0C1229	1	DECAL WARNING
35	070043	1	METER VOLT AC 0-300	85	024469	2	SCREW HHTT #10-32 X 3/8 CZ_
	070044	1	METER VOLT AC 0-600	86	0F3783	1	DECAL WARNING REMOVE FUSE
36	070042	1	METER FREQUENCY 55-65HZ				
	070042A	1	METER FREQUENCY 240V 45-55HZ				

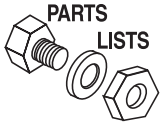

## Section 6 – Exploded Views and Parts Lists

### Control Panel (For Use With Generac Alternator) – Drawing No. 0A6325-N

For units manufactured prior to the 2nd quarter of 2000.

Standard drawing. Please refer to the Owner's Manual of the unit for specific details.

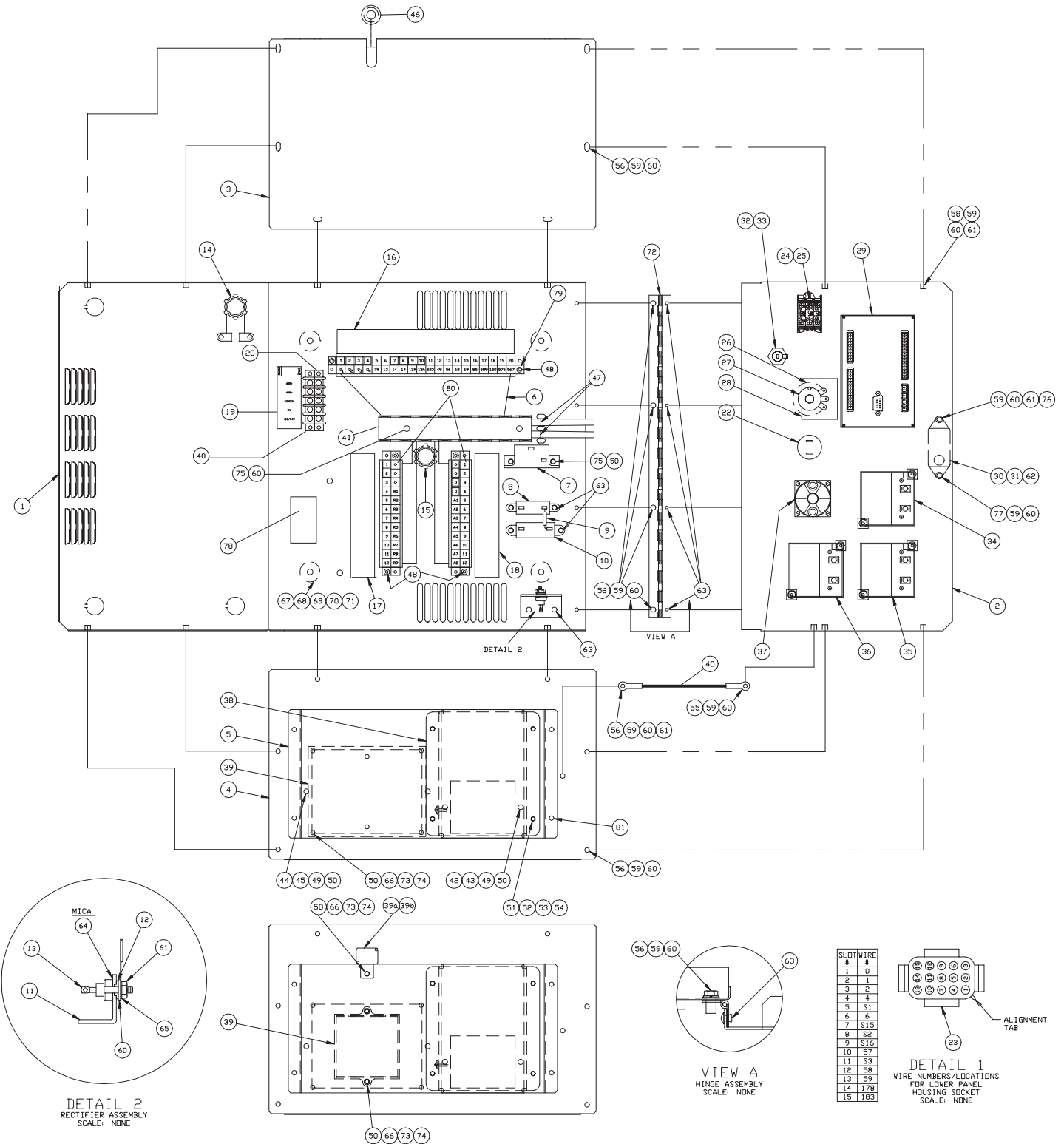

**TABLE A-FIELD BOOST RESISTOR DATA**

ALL DIRECTLY EXCITED MACHINES	5 OHM 25W
UPTD 100KW WITH 12 DR 24V DC SYSTEMS	P/N: 48829
ALL BRUSHLESS MACHINES	25 OHM 25W
UPTD 100KW WITH 12V DC SYSTEMS	P/N: 82465
ALL BRUSHLESS MACHINES	50 OHM 25W
UPTD 100KW WITH 24V DC SYSTEMS	P/N: 83364
ALL BRUSHLESS MACHINES	75 OHM 25W
UPTD 100KW WITH 12 DR 24V DC SYSTEMS	P/N: 86266

**TABLE B-AVR (DPE) CIRCUIT BREAKER DATA**

ALL DIRECTLY EXCITED MACHINES	7A
19 TO 45KW	P/N: 48467
ALL BRUSHLESS MACHINES	5 SA
19 TO 26KW	P/N: 54450
ALL BRUSHLESS MACHINES	6 DA
21 TO 41KW	P/N: 48505
ALL BRUSHLESS MACHINES	4 SA
45 TO 100KW	P/N: 48476
ALL BRUSHLESS MACHINES OVER 100KW	4 SA P/N: 48476

**TABLE C-AVR/ELECTRONIC GOVERNOR CONTROLLER DATA**

ALL 60HZ MACHINES WITH GENERAC ALTERNATORS USE AUTOMATIC VOLTAGE REGULATOR(AVR)	P/N: 67680
ALL 50HZ MACHINES WITH GENERAC ALTERNATORS USE AUTOMATIC VOLTAGE REGULATOR(AVR)	P/N: 92902
BARBER COLMAN 12V 2500-3000HZ ELECTRONIC GOVERNOR CONTROLLER	P/N: 67709
BARBER COLMAN 24V 2500-3000HZ ELECTRONIC GOVERNOR CONTROLLER	P/N: 67710
BARBER COLMAN 12V 5000-3500HZ ELECTRONIC GOVERNOR CONTROLLER	P/N: 67711

## Section 6 – Exploded Views and Parts Lists

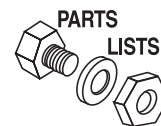

### Control Panel (For Use With Generac Alternator) – Drawing No. 0A6325-N

For units manufactured prior to the 2nd quarter of 2000.

Standard drawing. Please refer to the Owner's Manual of the unit for specific details.

ITEM	PART NO.	QTY.	DESCRIPTION	ITEM	PART NO.	QTY.	DESCRIPTION
1	0A6320	1	CONTROL PANEL BOTTOM	40	0A2275	1	FRONT PANEL STAY
2	0A6324	1	CONTROL PANEL FRONT	41	0A2400A	1	TRUNKING 180MM
3	0A6322	1	CONTROL PANEL RIGHT SIDE	42	0A1441B	1	COVER PLATE, AVR
4	0A6321	1	CONTROL PANEL LEFT SIDE	43	0A3393	1	DECAL, AVR COVER
5	0A6323	1	CHASSIS AVR/E GOV.	44	0A1441C	1	COVER PLATE, E-GOV
6	0A6326	1	HARNESS E PNL. MAIN	45	0A3394	1	DECAL, E-GOV COVER
7	SEE TABLE B	1	CIRCUIT BREAKER	46	030809	1	GROMMET 1/8-11/16
8	044213	1	RESISTOR 10 OHM 12W	47	028739	2	TIE WRAP 4"
9	025192	1	DIODE 600V 2A	48	0A1661	8	POP RIVET
10	SEE TABLE A	1	RESISTOR 2	49	036901	3	#6-32 X 3/8" PPHMS
11	055444	1	HEAT SINK	50	022155	9	#6/M3 LOCK WASHER
12	030468	1	STEP WASHER - NYLON	51	036918	4	#8-32 X 1/2" PPHMS
13	049939	1	RECTIFIER	52	022264	4	#8/M4 LOCK WASHER
14	039271	1	90° CONNECTOR 3/4"	53	038150	8	#8/M4 FLAT WASHER
15	034616	1	STRAIGHT CONNECTOR 3/4"	54	022471	4	#8-32 HEX NUT
16	0A3392-C	1	DECAL, TERMINAL STRIP	55	033120	1	#10-32 X 3/8" HHMS
17	0A6576	1	DECAL, TERMINAL STRIP TB2	56	033121	16	#10-32 X 1/2" HHMS
18	0A6577	1	DECAL, TERMINAL STRIP TB3	58	033147	1	#10-32 X 1" HHMS
19	0C2688	1	DECAL, TERMINAL STRIP TB4	59	022152	17	#10/M5 LOCK WASHER
20	048850	1	TERMINAL BLOCK, 5 POS TB4	60	023897	17	#10/M5 FLAT WASHER
22	061286	1	AUDIBLE ALARM	61	022158	4	#10-32 HEX NUT
23	055089	1	HOUSING SOCKET 15 - CKT	62	074130	1	LUG, PIN 4MM 22/18
24	0E2693A	1	SWITCH MUSHRM HEAD/ARROWS 40MM	63	036261	4	POP RIVET
25	0E2693C	3	CONTACT BLOCK D5-3X01 W/2,1417	64	070370	2	MICA WASHER
26	071361	1	POTENTIOMETER	65	023762	1	WASHER EXTERNAL SHAKE PROOF
27	050123	1	KNOB	66	022985	6	#6/M3 FLAT WASHER
28	055349	1	INSULATOR	67	040479	4	VIBRATION DAMPENER
29	0A4087	1	MASTER CONTROL BOX	68	022287	4	1/4-20 X 3/4" HHMS
30	070202	1	PANEL LIGHT	69	022097	4	1/4/M6 LOCK WASHER
31	070082	1	LIGHT BLOCKER	70	022473	4	1/4/M6 FLAT WASHER
32	032300	1	FUSE HOLDER	71	047246	4	1/4 FLAT WASHER SPECIAL
33	022676	1	FUSE 15-A	72	0A2273	1	HINGE
34	070045	1	AMMETER	73	036902	4	#6-32 X 1/2" PPHMS
35	070043	1	VOLT METER AC 0-300	74	022188	4	#6-32 HEX NUT
	070044	1	VOLT METER AC 0-600	75	0C2428	20	#6-32 X 1/2" TAPTITE
36	070042	1	FREQUENCY METER 60 HZ	76	024413	1	#10-32 X 1/2" TAPTITE
	070042A	1	FREQUENCY METER 50 HZ	77	0C2720	1	#10-32 X 3/8" TAPTITE
37	061945	1	VOLT/AMP SWITCH	*	0A5705	1	INTERNAL MODULE FUSE, 5A (NOT SHOWN)
38	SEE TABLE C	1	AVR ASSEMBLY	78	060164	1	SOCKET DPDT P& B
39	SEE TABLE C	1	OPTIONAL ELECTRICAL GOVERNOR	79	057335	1	TERMINAL STRIP
39A	098941A	1	HOUSING, CONNECTOR	80	055911	2	TERMINAL STRIP
39B	098942A	1	COVER, CONNECTOR HOUSING	81	0C2212	4	SCREW TAPTITE PH M4-0.7X16 ZYC

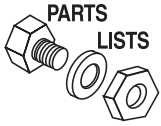

## Section 6 – Exploded Views and Parts Lists

### Control Panel (For Use With Marathon Alternator) – Drawing No. 0C3879-B

For units manufactured prior to the 2nd quarter of 2000.

Standard drawing. Please refer to the Owner's Manual of the unit for specific details.

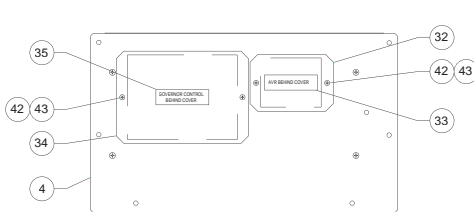
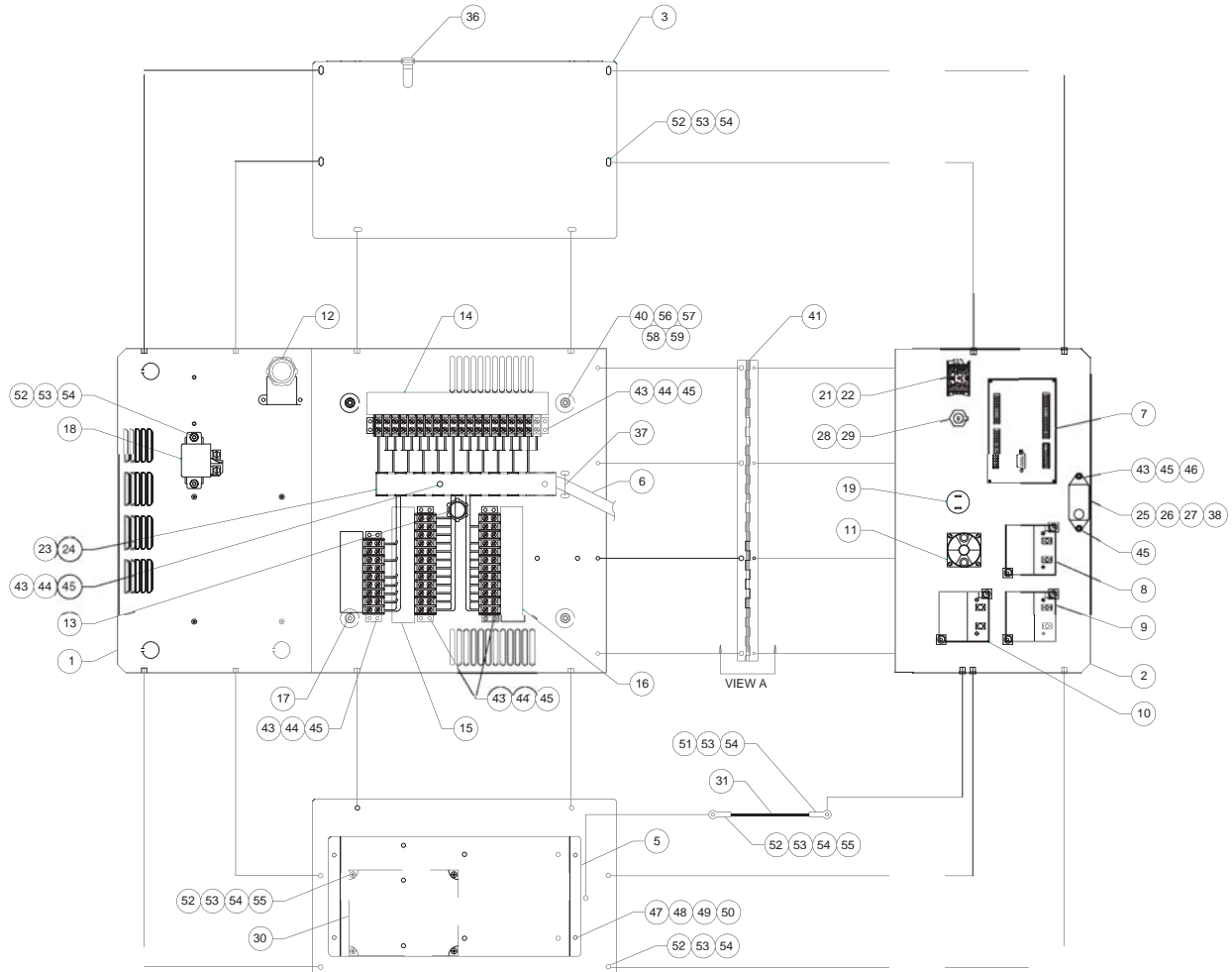

CONTROL PANEL LEFT SIDE  
OUTSIDE VIEW

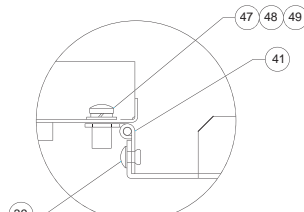

VIEW A  
HINGE ASSEMBLY  
SCALE: NONE

SLOT #	WIRE #
1	0
2	1
3	2
4	4
5	S1
6	6
7	S15
8	S2
9	S16
10	57
11	S3
12	58
13	59
14	178
15	183

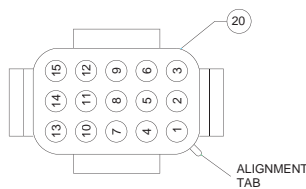

DETAIL 1  
WIRE NUMBERS/LOCATIONS  
FOR LOWER PANEL  
HOUSING SOCKET  
SCALE: NONE  
REAR VIEW

## Section 6 – Exploded Views and Parts Lists

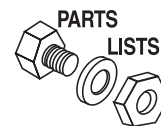

### Control Panel (For Use With Marathon Alternator) – Drawing No. 0C3879-B

For units manufactured prior to the 2nd quarter of 2000.

Standard drawing. Please refer to the Owner's Manual of the unit for specific details.

ITEM	PART NO.	QTY.	DESCRIPTION	ITEM	PART NO.	QTY.	DESCRIPTION
1	0C2616	1	E PANEL BOTTOM 400>	31	0A2275	1	DOOR-STOP RAM PANEL
2	0C3872	1	FRONT E PANEL 400>	32	0A1441B	1	COVER PLATE, AVR
3	0A6322	1	PANEL RIGHT SIDE E	33	0C1127	1	DECAL AVR COVER
4	0A6321	1	PANEL LEFT SIDE E	34	0A1441C	1	COVER PLATE EGOV
5	0A6323	1	CHASSIS AVR & E-GOV	35	0C1126	1	DECAL ELEC GOVERNOR COVER
6	0C1377	1	HARNESS E-PANEL 400>	36	030809	1	GROMMET 11/16 X 1/8 X 7/16
7	0A4087	1	MASTER CONTROL BOX E-PANEL	37	029333	1	TIE WRAP UL 7.4" X .19" NATL
8	SEE NOTE	1	AMMETER	38	074130	1	LUG DIS SN-PLG I-T 22-18 CU
9	SEE NOTE	1	VOLT METER AC	39	036261	4	RIVET POP .125 X .275 AL
10	SEE NOTE	1	FREQUENCY METER	40	040479	4	VIB MNT 1.0 X 1.0 X 1/4-20
11	074386	1	SWITCH SELECT VOLT/AMP 3PH	41	0A2273	1	HINGE RAM PANEL
12	0A9234	1	GEDNEY CONN 1IN 90	42	036901	4	SCREW PPHM #6-32 X 3/8
13	034616	1	FITTING STRAIGHT 3/4	43	022155	18	WASHER LOCK #6
14	0C3207	1	DECAL T STRIP 1 E PNL	44	022985	12	WASHER FLAT #6 ZINC
15	0A6576	1	DECAL T STRIP 2 E PNL	45	0C2428	14	SCREW PHTT #6-32 X 1/2 ZYC
16	0C3208	1	DECAL T STRIP 3 E PNL	46	022188	1	NUT HEX #6-32 STEEL
17	0C3206	1	DECAL T STRIP 4 E PNL	47	036918	8	SCREW PPHM #8-32 X 1/2
18	0C4110	1	RELAY 24V 50A W/DIODE	48	022264	8	WASHER LOCK #8-M4
19	061286	1	SOUNALERT BUZZER	49	038150	8	WASHER FLAT #8 ZINC
20	055089	1	CONN PLUG PNL 15P AMP M-N-L	50	022471	4	NUT HEX #8-32 STEEL
21	0E2693A	1	SWITCH MUSHRM HEAD/ARROWS 40MM	51	033120	1	SCREW HHC #10-32 X 3/8
22	0E2693C	3	CONTACT BLOCK D5-3 X 01 W/2 1417	52	033121	17	SCREW HHC #10-32 X 1/2
23	091472	1	DUCT WIRING 1 X 1.5 6 FT (9.5")	53	022152	20	WASHER LOCK #10
24	091472A	1	COVER WIRE DUCT 1 IN (9.5")	54	023897	20	WASHER FLAT #10 ZINC
25	083287	1	LIGHT HLDR CLR LNS W/O BULB	55	022158	7	NUT HEX #10-32 STEEL
26	083288	1	LIGHT 28VDC .17A MIN BAYNT MNT	56	022287	4	SCREW HHC 1/4-20 X 3/4 G5
27	070082	1	BLOCKER LIGHT	57	022097	4	WASHER LOCK M6-1/4
28	032300	1	HOLDER FUSE	58	022473	4	WASHER FLAT 1/4-M6 ZINC
29	022676	1	FUSE 15A X AGC15	59	047246	4	FLAT WASHER SPECIAL
30	084752	1	CONTROLLER GOVERNOR ELECTRONIC				

NOTE: CONTACT GENERAC SERVICE FOR CORRECT PART NUMBER FOR YOUR UNIT.



## Section 6 – Exploded Views and Parts Lists

### Control Panel (For Use With Generac Alternator) – Drawing No. 0C8459-J

For units manufactured starting the 2nd quarter of 2000 thru 3rd quarter 2002.

Standard drawing. Please refer to the Owner's Manual of the unit for specific details.

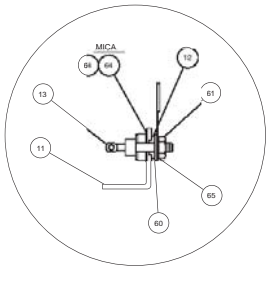
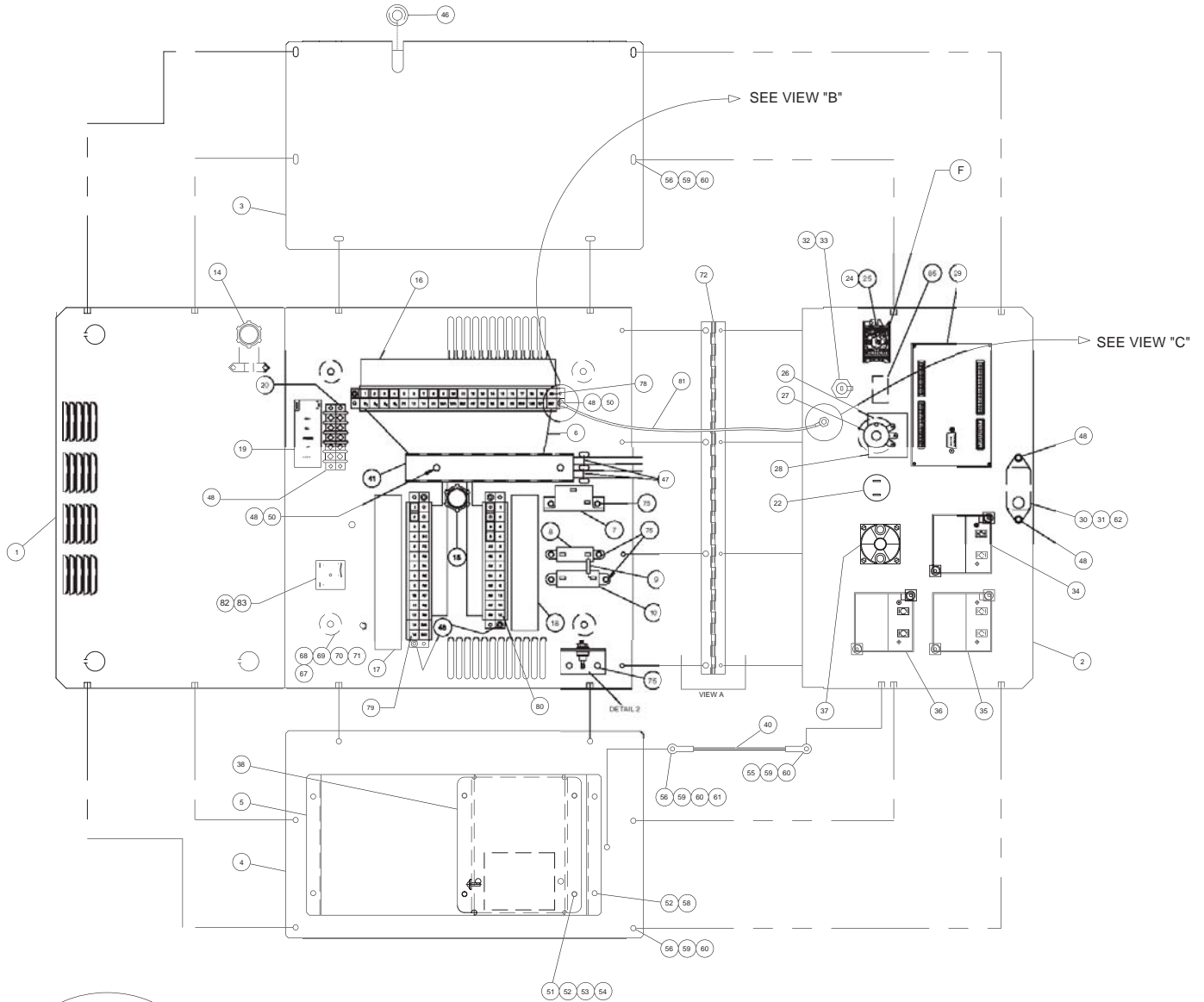

DETAIL 2  
RECTIFIER ASSEMBLY  
SCALE: NONE

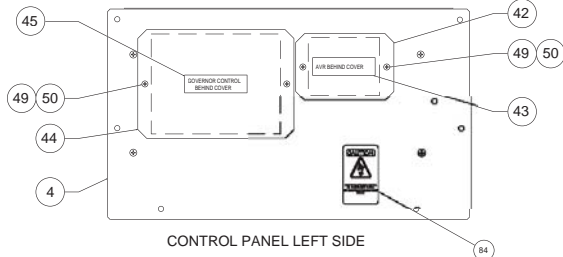

CONTROL PANEL LEFT SIDE

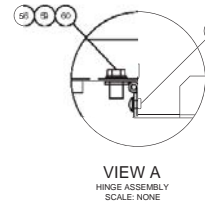

VIEW A  
HINGE ASSEMBLY  
SCALE: NONE

SLOT #	WIRE #
1	0
2	1
3	2
4	4
5	S1
6	6
7	S15
8	S2
9	S16
10	S7
11	S3
12	S8
13	S9
14	138
15	183

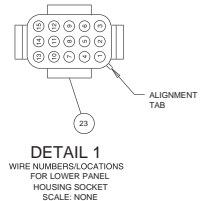

DETAIL 1  
WIRE NUMBERS/LOCATIONS  
FOR LOWER PANEL  
HOUSING SOCKET  
SCALE: NONE

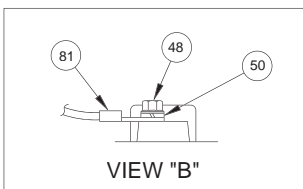

VIEW "B"

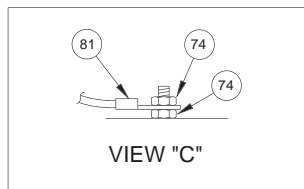

VIEW "C"

TABLE A-FIELD BOOST RESISTOR DATA	
ALL DIRECTLY EXCITED MACHINES	5 OHM 25W
18 TO 45KW WITH 12 OR 24V DC SYSTEMS	P/N: 048352
ALL BRUSHLESS & PME MACHINES	25 OHM 25W
18 TO 100KW WITH 12V DC SYSTEMS	P/N: 057405
ALL BRUSHLESS & PME MACHINES	50 OHM 25W
18 TO 100KW WITH 24V DC SYSTEMS	P/N: 053554
ALL BRUSHLESS & PME MACHINES	75 OHM 25W
COVER 100KW WITH 12 OR 24V DC SYSTEMS	P/N: 080266

TABLE B-AVR POWER(DPE) CIRCUIT BREAKER DATA	
ALL DIRECTLY EXCITED MACHINES	7A
18 TO 45KW	P/N: 048467
ALL BRUSHLESS & PME MACHINES	50A
18 TO 25KW	P/N: 054450
ALL BRUSHLESS & PME MACHINES	60A
21 TO 41KW	P/N: 048505
ALL BRUSHLESS & PME MACHINES	45A
45 TO 100KW	P/N: 048476
ALL BRUSHLESS & PME MACHINES	45A
COVER 100KW	P/N: 048476

## Section 6 – Exploded Views and Parts Lists

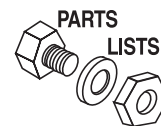

**Control Panel (For Use With Generac Alternator) – Drawing No. 0C8459-J**  
**For units manufactured starting the 2nd quarter of 2000 thru 3rd quarter 2002.**  
**Standard drawing. Please refer to the Owner's Manual of the unit for specific details.**

ITEM	PART NO.	QTY.	DESCRIPTION	ITEM	PART NO.	QTY.	DESCRIPTION
1	0A6320	1	CONTROL PANEL BOTTOM	37	061945	1	SWITCH 6A AMP/V SELECTOR
2	0A6324	1	CONTROL PANEL FRONT	38	067680	1	ASSY VOLTAGE REGULATOR 60HZ
3	0A6322	1	CONTROL PANEL RIGHT SIDE		092952	1	ASSY VOLTAGE REGULATOR 50HZ
4	0A6321	1	CONTROL PANEL LEFT SIDE	40	0A2275	1	DOOR-STOP RAM PANEL
5	0E3550	1	CHASSIS, UNIVERSAL	41	0A2400A	1	TRUNKING 180MM
6	0C8320	1	HARNESS E PNL. WAUK (W/FS)	42	0A1441B	1	COVER PLATE AVR
7	SEE TABLE B	1	CIRCUIT BREAKER	43	0C1127	1	DECAL AVR COVER
8	044213	1	RESIST MISC 10RX12W	44	0A1441C	1	COVER PLATE E-GOV
9	025192	1	RECTIFIER MSC 2A 600V 1N5062	45	0A3394	1	DECAL E-GOV COVER
10	SEE TABLE A	1	RESISTOR 2	46	030809	1	GROMMET 11/16 X 1/8 X 7/16
11	055444	1	HEAT SINK	47	028739	2	TIE WRAP 4" WHITE
12	030468	1	WASHER STEP NYLON .20	48	0C2323	12	SCREW PHM SWAGE 6-32 X 5/8 Z/YC
13	049939	1	RECTIFIER MSC 12A 600V 1N1206R	49	036901	4	SCREW PPHM #6-32 X 3/8
14	039271	1	FITTING 90DEGREE 3/4	50	022155	7	WASHER LOCK #6
15	034616	1	FITTING STRAIGHT 3/4	51	036918	8	SCREW PPHM #8-32 X 1/2
16	0A3392	1	DECAL TERMINAL STRIP	52	022264	8	WASHER LOCK M4
17	0C8229	1	DECAL E PNL TS#2 (W/FS)	53	038150	4	WASHER FLAT #8 ZINC
18	0A6577	1	DECAL TERMINAL STRIP TB3	54	022471	4	NUT HEX #8-32 STEEL
19	0C2688	1	DECAL TERMINAL STRIP TB4	55	033120	1	SCREW HHM 10-32 X 3/8
20	048850	REF.	BLOCK TERM 20A 5 X 6 X 1100V	56	033121	13	SCREW HHM 10-32 X 1/2
22	061286	1	AUDIBLE ALARM	58	0A2284	4	SCREW SWAGE 8-32 X 1/2 Z/YC
23	055089	1	CONN ELEC AMP M-N-L 15PLUG PNL	59	022152	14	WASHER LOCK #10
24	0E2693A	1	SWITCH MUSHRM HEAD/ARROWS 40MM	60	023897	15	WASHER FLAT #10 ZINC
25	0E2693C	3	CONTACT BLOCK D5-3 X 01 W/2 1417	61	022158	2	NUT HEX #10-32 STEEL
26	071361	1	POTENTIOMETER PNL 5K +/-10% 2.25W	62	074130	1	LUG DIS SN-PLG I-T 22-18 CU
27	050123	1	KNOB PLASTIC .25 SHAFT	63	036261	4	RIVET POP .125 X .129-.133/#30
28	055349	1	INSULATOR	64	070370	2	WASHER MICA .203
29	0A4087	1	MASTER CONTROL BOX	65	023762	1	WASHER SHAKEPROOF EXT #10 STL
30	0C8481	REF.	BULB-PANEL LIGHT-12V	67	040479	4	MOUNT VIBR 1.0 X 1.0 X 1/4-20
	0E3703	REF.	LIGHT PANEL WITH LUG	68	022287	4	SCREW HHC 1/4-20 X 3/4 G5
	083288	REF.	LIGHT 28VDC .17A MIN BAYNT MNT	69	022097	4	WASHER LOCK M6-1/4
31	070082	1	LIGHT BLOCKER	70	022473	4	WASHER FLAT M6-1/4 ZINC
32	032300	1	FUSE HOLDER	71	047246	4	WASHER FLAT 1/4 SPECIAL
33	022676	1	FUSE 15A X AGC15	72	0A2273	1	HINGE RAM PANEL
34	070054	1	AMMETER AC 0-50	74	022188	2	NUT HEX #6-32 STEEL
	070055	1	AMMETER AC 0-100	75	0C2428	8	SCREW TAPTITE PH #6-32 X 1/2 ZYC
	070056	1	AMMETER AC 0-150	*	0A5705	1	FUSE 5A X LTTL215005 HLDRA4017 (NOT SHOWN)
	070057	1	AMMETER AC 0-300	78	057335	REF.	BLOCK TERM 20A 20 X 6 X 1100V
	070058	1	AMMETER AC 0-400	79	0C4167	REF.	BLOCK TERM 20A 14 X 6 X 1100V
	070059	1	AMMETER AC 0-600	80	055911	REF.	BLOCK TERM 20A 12 X 6 X 1100V
	070060	1	AMMETER AC 0-800	81	0441140156	REF.	WIRE ASSEMBLY
	075323	1	AMMETER AC 0-1000	82	084717	1	ASSY TIME DELAY (13.3L GAS ONLY)
	075324	1	AMMETER AC 0-1600	83	036908	1	SCREW PPHM #6-32 X 1-1/4 (13.3L GAS ONLY)
	075325	1	AMMETER AC 0-2000	84	0C1229	1	DECAL WARNING
35	070043	1	METER VOLT AC 0-300	85	0E3783	1	DECAL WARNING REMOVE FUSE
	070044	1	METER VOLT AC 0-600				
36	070042	1	METER FREQUENCY 55-65HZ				
	070042A	1	METER FREQUENCY 240V 45-55HZ				

**Section 6 – Exploded Views and Parts Lists**

**Control Panel (For Use With Marathon Alternator) – Drawing No. 0C8460-G**

For units manufactured starting the 2nd quarter of 2000.

Standard drawing. Please refer to the Owner's Manual of the unit for specific details.

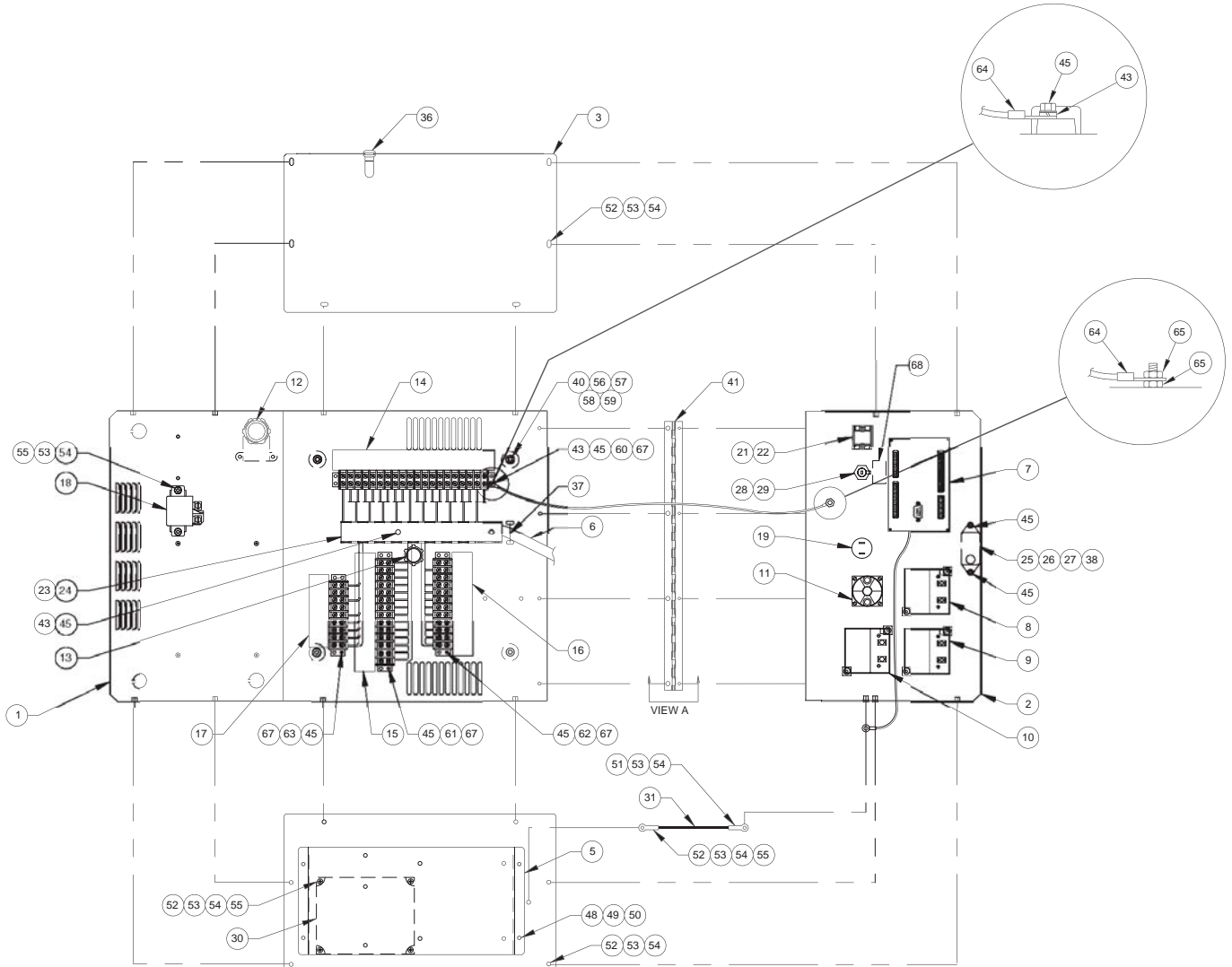

SLOT #	WIRE #
1	0
2	1
3	2
4	4
5	S1
6	6
7	S15
8	S2
9	S16
10	57
11	S3
12	58
13	59
14	178
15	183

**DETAIL 1**  
WIRE NUMBERS/LOCATIONS  
FOR LOWER PANEL  
HOUSING SOCKET  
SCALE: NONE  
REAR VIEW

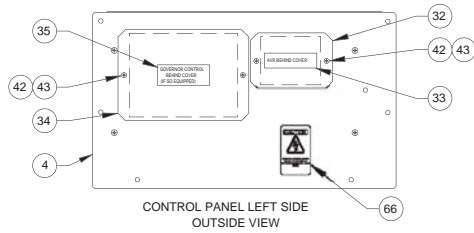
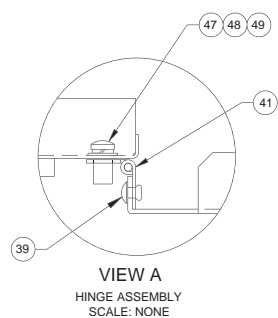

## Section 6 – Exploded Views and Parts Lists

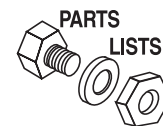

### Control Panel (For Use With Marathon Alternator) – Drawing No. 0C8460-G

For units manufactured starting the 2nd quarter of 2000.

Standard drawing. Please refer to the Owner's Manual of the unit for specific details.

ITEM	PART NO.	QTY.	DESCRIPTION	ITEM	PART NO.	QTY.	DESCRIPTION
1	0C2616	1	CONTROL PANEL BOTTOM	35	0A3394	1	DECAL ELECTRONIC GOVERNOR
2	0C3872	1	CONTROL PANEL FRONT	36	030809	1	GROMMET 11/16 X 1/8 X 7/16
3	0A6322	1	CONTROL PANEL RIGHT SIDE	37	029333	1	TIE WRAP 7" WHITE
4	0A6321	1	CONTROL PANEL LEFT SIDE	38	074130	1	LUG DIS SN-PLG I-T 22-18 CU
5	0E3550	1	CHASSIS, UNIVERSAL	39	036261	4	RIVET POP .125 X .129-.133/#30
6	0C8328	1	HARNESS E PANEL MAIN	40	040479	4	MOUNT VIBR 1.00 X 1.00 X 1/4-20
7	0A4087	1	MASTER CONTROL BOX	41	0A2273	1	HINGE RAM PANEL
8	SEE NOTE	1	AMMETER	42	036901	4	SCREW PPHM #6-32 X 3/8
9	SEE NOTE	1	VOLT METER AC	43	022155	7	WASHER LOCK #6
10	SEE NOTE	1	FREQUENCY METER	45	0C2323	12	SCREW TAPTITE PH 6-32 X 5/8 ZYC
11	074386	1	SWITCH VOLT/AMP	47	036918	4	SCREW PPHM #8-32 X 1/2
12	0A9234		CONNECTOR 90 DEGREE ELBOW	48	022264	8	WASHER LOCK M4
13	034616	1	FITTING STRAIGHT 3/4	49	038150	4	WASHER FLAT M4
14	0C3207	1	DECAL TERM STRIP TB1	50	0A2284	4	SCREW SWAGE 8-32 X 1/2 Z/YC
15	0C8229	1	DECAL TERM STRIP TB2	51	033120	1	SCREW HHM 10-32 X 3/8
16	0C3208	1	DECAL TERM STRIP TB3	52	033121	17	SCREW HHM 10-32 X 1/2
17	0C3206	1	DECAL TERM STRIP TB4	53	022152	20	WASHER LOCK #10
18	0C4110	1	RELAY 24V 50A W/DIODE	54	023897	20	WASHER FLAT #10 ZINC
19	061286	1	ALARM AUDIBLE	55	022158	6	NUT HEX #10-32 STEEL
20	055089	1	CONN ELEC AMP M-N-L 15PLUG PNL	56	022287	4	SCREW HHC 1/4-20 X 3/4 G5
21	098426A	1	SWITCH EMERGENCY STOP	57	022097	4	WASHER LOCK M6-1/4
22	098426C	3	CONTACT EMERGENCY STOP SWITCH	58	022473	4	WASHER FLAT M6-1/4 ZINC
				59	047246	4	WASHER FLAT 1/4 SPECIAL
23	091472	9.5"	WIRE DUCT1 X 1.5	60	057335	1	BLOCK TERM 20 POS TB1
24	091472A	9.5"	WIRE DUCT COVER 1"	61	0C4167	1	BLOCK TERM 20A 14 X 6 X 1100V
25	0E3703	1	LIGHT PANEL WITH LUG	62	055911	1	BLOCK TERM 20A 12 X 6 X 1100V
26	083288	1	LIGHT 28VDC .17A MIN BAYNT MNT	63	061520	1	BLOCK TERM 20A 9 X 6 X 1100V
27	070082	1	LIGHT BLOCKER	64	0441140156	1	WIRE ASSY 18AWG #0
28	032300	1	FUSE HOLDER	65	022188	2	NUT HEX #6-32 STEEL
29	022676	1	FUSE 15A X AGC15	66	0C1229	1	DECAL WARNING
30	067710	1	CONTROLLER ELECTRONIC GOVERNOR	67	046669	17	BLOCK TERM JUMPER
				68	0E3783	1	DECAL, WARNING REMOVE FUSE
31	0A2275	1	DOOR-STOP RAM PANEL				
32	0A1441B	1	COVER PLATE AVR				
33	0C1127	1	DECAL AVR COVER				
34	0A1441C	1	COVER PLATE ELECTRONIC GOVERNOR				

NOTE: CONTACT GENERAC SERVICE FOR CORRECT PART NUMBER FOR TOUR UNIT.





**GENERAC® POWER SYSTEMS, INC.**

P.O. BOX 8  
WAUKESHA, WI 53187

**Part No. OA7605**

**Revision K (06/17/03)**

**Printed in U.S.A.**