

GENERAC®

POWER SYSTEMS, INC.

Operator's Manual

"C" Option Control Panel

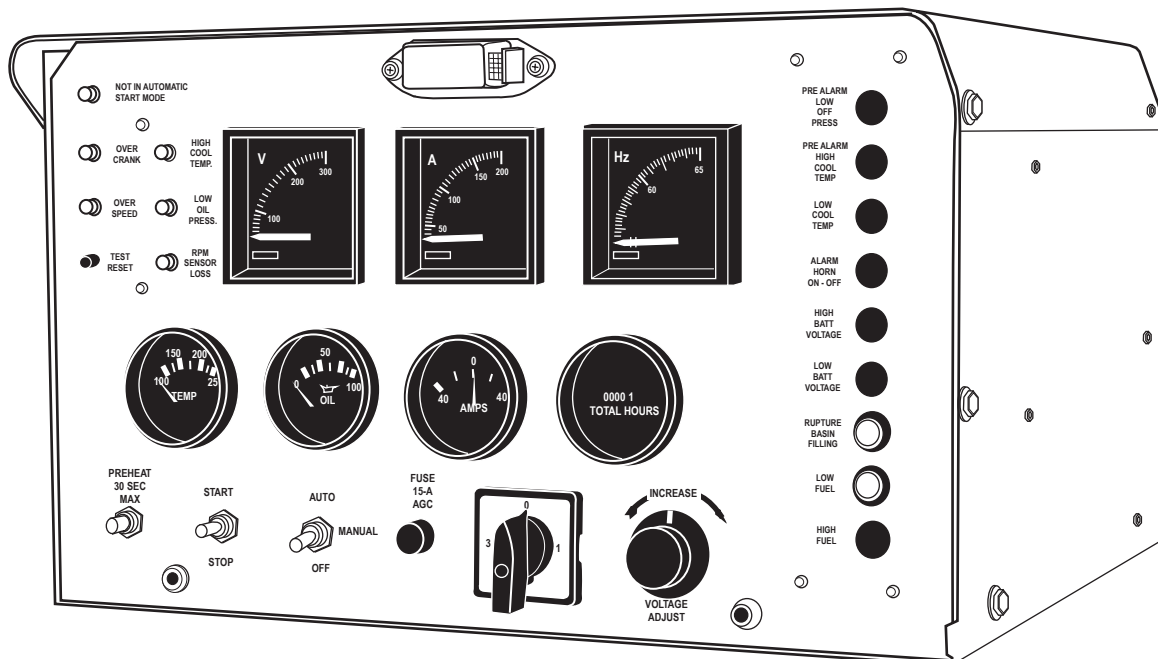

This manual should remain with the unit.



Important Safety Instructions

"C" Option Control Panel

SAVE THESE INSTRUCTIONS – *The manufacturer suggests that these rules for safe operation be copied and posted in potential hazard areas. Safety should be stressed to all operators and potential operators of this equipment.*

Study these SAFETY RULES carefully before installing, operating, or servicing this equipment. Become familiar with this manual and all literature pertaining to the generator set and related equipment. This equipment can operate safely, efficiently, and reliably only if it is properly installed, operated, and maintained. Many accidents are caused by failing to follow simple and fundamental rules or precautions.

Generac cannot possibly anticipate every possible circumstance that might involve a hazard. The warnings in this manual, and on tags and decals affixed to the equipment, are, therefore, not all-inclusive. If using a procedure, work method, or operating technique Generac does not specifically recommend, you must satisfy yourself that it is safe for you and others. Also must make sure the procedure, work method, or operating technique that is used does not render the equipment unsafe.

GENERAL HAZARDS

- For safety reasons, Generac recommends that this equipment be installed and serviced by a Generac Authorized Service Dealer or other qualified electrician or installation technician who is familiar with applicable codes, standards, and regulations. The operator also must comply with all such codes, standards, and regulations.
- When working on this equipment, remain alert at all times. Never work on the equipment when physically or mentally fatigued.
- Inspect the equipment regularly, and promptly repair or replace all worn, damaged or defective parts, using only factory-approved parts.
- Before performing any maintenance on the generator or any related equipment, disconnect the generator's battery cables and remove panel fuse to prevent accidental startup. Disconnect the cable from the battery post, indicated by a NEGATIVE, NEG, or (–) first. Reconnect that cable last.

ELECTRICAL HAZARDS

- Generators produce dangerous electrical voltages and can cause fatal electrical shock. Avoid contact with bare wires, terminals, connections, etc., while the generator and related equipment are running. Ensure all appropriate covers, guards, and barriers are in place before operating the equipment. If working around an operating unit, stand on an insulated, dry surface to reduce potential shock hazards.

- Do not handle any kind of electrical device while standing in water, while barefoot, or while hands or feet are wet. DANGEROUS ELECTRICAL SHOCK MAY RESULT.
- If people must stand on metal or concrete while installing, operating, servicing, adjusting, or repairing this equipment, place insulative mats over a dry wooden platform. Work on the equipment only while standing on such insulative mats.
- Wire gauge sizes of electrical wiring, cables, and cord sets must be adequate to handle the maximum electrical current (amperage) to which they will be subjected to.
- Before installing or servicing this equipment, make sure that all power voltage supplies are positively TURNED OFF at their source. Failure to do so will result in hazardous and possibly fatal electrical shock.
- When installed with an automatic transfer switch, the generator may crank and start anytime, without warning. To prevent injuries caused by sudden start-up, disable the generator's automatic start circuit before working on, or around, the unit. Then, place a "Do Not Operate" tag on the generator control panel and on the transfer switch.
- In case of an accident caused by electric shock, immediately shut down the source of electrical power. If this is not possible, attempt to free the victim from the live conductor. AVOID DIRECT CONTACT WITH THE VICTIM. Use a nonconducting implement, such as, a rope or board, to free the victim from the live conductor. If the victim is unconscious, apply first aid and get immediate medical help.
- Never wear jewelry when working on this equipment. Jewelry can conduct electricity, resulting in electric shock, or may get caught in moving components, causing injury.

FIRE HAZARDS

- For fire safety, the generator and related equipment must be installed and maintained properly. Installation always must comply with applicable codes, standards, laws, and regulations. Adhere strictly to local, state, and national electrical and building codes. Comply with regulations the Occupational Safety and Health Administration (OSHA) has established. Also, ensure that the equipment is installed in accordance with the manufacturer's instructions and recommendations. Following proper installation, do nothing that might alter a safe installation and render the unit in noncompliance with the aforementioned codes, standards, laws, and regulations.

Part I - C Option Control Panel

Safety RulesInside Front Cover

Section 1 – General Information2

1.1 Overview2

1.2 Control Panel Components2

1.3 Optional Equipment2

1.3.1 Remote Annunciator Panel.....2

1.3.2 Remote Relay Panel2

1.3.3 Additional Options.....2

1.4 Panel Face Components2

1.4.1 AC Voltmeter2

1.4.2 AC Ammeter2

1.4.3 Frequency Meter2

1.4.4 Line-Phase Selector Switch3

1.4.5 Voltage Adjust Potentiometer3

1.4.6 Coolant Temperature Gauge3

1.4.7 Oil Pressure Gauge3

1.4.8 DC Voltmeter3

1.4.9 Hourmeter3

1.4.10 Start/Stop Switch.....4

1.4.11 Auto/Off/Manual Switch4

1.4.12 Panel Fuse4

1.5 Engine Monitor Panel4

1.5.1 Not in Automatic Start Mode Lamp4

1.5.2 Overcrank Lamp4

1.5.3 High Coolant Temperature Lamp.....4

1.5.4 Overspeed Lamp4

1.5.5 Low Oil Pressure Lamp5

1.5.6 RPM Sensor Loss Lamp.....5

1.5.7 Test/Reset Switch5

1.6 Optional Annunciator Panel5

1.7 Optional Remote Annunciator6

1.8 Optional Alarm Relay6

1.9 Preparation Before Startup6

1.9.1 Prior to Initial Startup6

1.9.2 Startup Inspection7

Section 2 – Operation7

2.1 Operating Unit with Manually-Operated Transfer Switch7

2.2 Operating Unit with Automatic Transfer Switch ..7

2.2.1 Manual Startup and Transfer7

2.2.2 Manual Retransfer and Engine Shutdown7

2.2.3 Preventing Automatic Startup8

Appendix 1 – Electrical Data9

Appendix 2 – Exploded Views and Parts Lists16

Appendix 3 – Interconnection Diagrams24

Part II - Remote Annunciator Panels

Section 1 – General Information29

1.1 Three Light Remote Annunciator29

1.1.1 Installation.....29

1.2 Five Light Remote Annunciator29

1.2.1 Operation.....30

1.2.2 Customer Connections.....30

1.2.3 Parts Included with Remote Panel30

1.3 18 Light Remote Annunciator30

1.3.1 Generator Stop Signals31

1.3.2 Latchable Signals.....31

1.3.3 Other Lamps31

1.3.4 Panel Wiring Interconnections31

1.4 Troubleshooting31

1.5 Annunciated Signals32

1.6 Pre-Alarms32

Appendix 4 – Electrical Data33

Appendix 5 – Exploded Views and Parts Lists41

Appendix 6 – Notes47

**AUTHORIZED SERVICE
DEALER LOCATION**

To locate the nearest GENERAC AUTHORIZED SERVICE DEALER, please call this number:

1-800-333-1322

DEALER LOCATION INFORMATION
CAN BE OBTAINED AT THIS NUMBER.

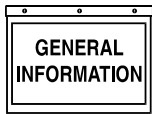

1.1 OVERVIEW

The “C” option control panel is an analog generator set control panel designed for Generac’s range of standby generators. It allows for either manual or automatic startup and shutdown.

The panel is housed in a steel sheet metal enclosure that meets NEMA 1 specifications. The front face of the panel includes a number of analog meters and gauges that indicate generator operating conditions, several indicator lamps for annunciation of engine fault shutdowns, and various other generator set controls.

1.2 CONTROL PANEL COMPONENTS

The control panel contains one main printed-circuit board (PCB), the automatic voltage regulator (AVR), optional components, such as battery monitor, dry contact boards, run relay, etc., and terminal blocks for external connections.

To find locations of the circuit board, refer to Appendix 2 for the control panel exploded view.



Remove the 15-amp fuse from the front of the panel during all engine maintenance to guard against accidental or remote startup.

1.3 OPTIONAL EQUIPMENT

1.3.1 REMOTE ANNUNCIATOR PANEL

When connected to the generator via a 19 wire connection link, this multi-light remote indicator panel will display the generator’s status.

1.3.2 DRY CONTACTS

This panel is similar to the remote annunciator, but, in addition to indicator lights, it provides relay contact closures for status (e.g., alarms). The dry contact boards are form C rated contacts. The five function dry contacts are normally open (N.O.). The six function dry contacts are either normally open (N.O.) or normally closed (N.C.).

1.3.3 ADDITIONAL OPTIONS

The following are some of the more frequently requested optional accessories for the “C” option control panel:

- Emergency stop button
- Oil temperature gauge
- Engine run relay
- 100 dBa alarm horn
- Over/Under voltage relay
- Pre-alarm kit
- Control panel heater(s)
- Voltage change over switch (special)
- Battery monitor
- Over/Under frequency relay
- Over/Under current relay

1.4 PANEL FACE COMPONENTS

(FIGURE 1.1, PAGE 3)

1.4.1 AC VOLTMETER

This meter indicates the generator AC output voltage. (Also see “Line-phase Selector Switch” and “Voltage Adjust Potentiometer” in this section). To determine the nominal rated AC voltage of the unit, refer to the unit’s data plate.

NOTE:

Some generators are reconnectable to a variety of voltages. Some units may be equipped with a rotary “Voltage Selector Switch.” Be sure to read the “Generator AC Lead Connections” section in the Owner’s Manual.

1.4.2 AC AMMETER

This meter indicates the current draw of connected electrical loads, in amps. (Also see “Line-phase Selector Switch”). For continuous operation, never exceed the rated maximum continuous current capacity of the generator.

1.4.3 FREQUENCY METER

This meter indicates the generator’s AC output frequency in “Hertz” (cycles per second).

Figure 1.1 – "C" Option Panel Components

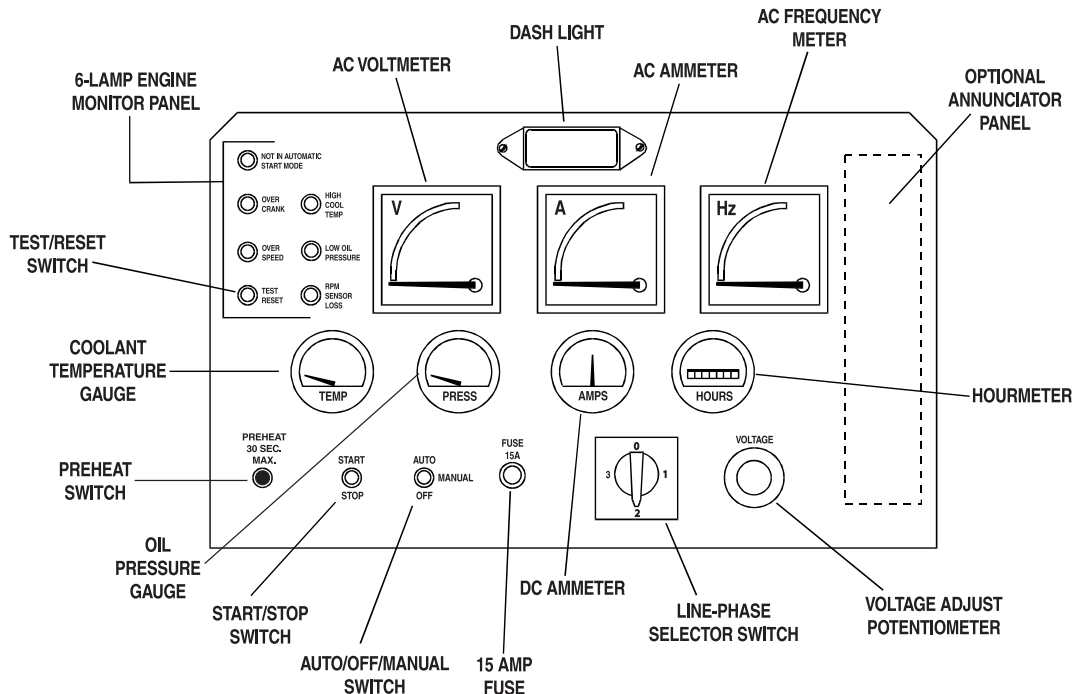

◆ 1.4.4 LINE-PHASE SELECTOR SWITCH

This four-position switch permits selection of either line-to-line or line-to-neutral readings on the panel voltmeter and ammeter. Switch positions are as follows:

Switch	Single-phase Units	Three-phase units
1	Line E1 to Neutral	Line E1 to E2
2	Line E3 to Neutral	Line E2 to E3
3	Line E1 to E3	Line E3 to E1
O	No Reading	No Reading

◆ 1.4.5 VOLTAGE ADJUST POTENTIOMETER

This potentiometer permits the operator to "fine-adjust" the generator's AC output voltage. Adjustment range is plus or minus five percent from the mid-point. Turn the knob clockwise to increase voltage, counterclockwise to decrease voltage.

◆ 1.4.6 COOLANT TEMPERATURE GAUGE

This gauge indicates the engine coolant temperature. Normal operating temperature should read between 185° to 215°F (85° to 102°C). If coolant temperature exceeds a safe level, the engine shuts down automatically.

NOTE:

Actual coolant temperature reading may vary due to variables, such as, ambient temperature, applied load, or cooling system condition.

◆ 1.4.7 OIL PRESSURE GAUGE

This gauge indicates oil pressure during operation. After warm-up, oil pressure should be about 25-90 psi. Generac recommends that the operator record the normal oil pressure during initial startup. Sudden changes in oil pressure after first starting indicate a possible engine problem.

NOTE:

Engine oil pressure may vary, depending on oil viscosity, oil temperature, engine speed, ambient temperature, etc. The engine automatically shuts down if oil pressure drops below a safe level. (10 psi.)

◆ 1.4.8 DC AMMETER

The engine is equipped with a belt-driven DC alternator, which charges the battery while the unit is running. This ammeter indicates the rate of charge to the battery during operation. If the needle drops to the left of zero, the battery is discharging. Investigate and correct this problem immediately. Erratic movement of the needle should also be corrected immediately.

◆ 1.4.9 HOURMETER

The hourmeter provides a continuous indication of engine/generator operating time, in hours and tenths of hours. Use the hourmeter with the periodic maintenance schedule.

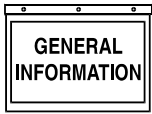

◆ 1.4.10 START/STOP SWITCH

Use this switch to crank and start the engine manually, or to shut down an operating engine.

- To crank and start engine, first set the Auto/Off/Manual switch to its "Manual" position.
- Hold the Start/Stop switch at "Start." When the engine starts, release the switch to its center (run) position.
- To shut engine down, move the switch to its "Stop" position.

◆ 1.4.11 AUTO/OFF/MANUAL SWITCH

This safety switch should be used to prevent automatic startup of the engine when working on the engine/generator. Use the switch as follows:

▶ Auto Position

Always set switch to AUTO for automatic system operation. This means that, when this generator is installed with a GTS-type automatic transfer switch, the generator automatically cranks and starts when the utility source voltage drops below a preset level, or the unit exercises, if programmed to do so.

▶ Off Position

The engine cannot be started either automatically or manually. Always set switch to OFF before working on, or around, the engine-generator.

▶ Manual Position

The engine can be cranked and started manually using the panel Start/Stop switch. The engine will not start automatically.

NOTE:

Also see "Engine Monitor Panel." With switch set to either OFF or MANUAL, a "Not in Automatic Start Mode" lamp lights up on the panel.

◆ 1.4.12 PANEL FUSE

This fuse protects the control console's DC circuits against overload. If the fuse element melts open due to an overload, engine cranking and startup will not be possible. Should fuse replacement become necessary, use only an identical fuse (part number 022676).

1.5 ENGINE MONITOR PANEL

This panel has five advisory shutdown lamps for separate engine fault conditions, plus a "Not in Automatic Start Mode" lamp. Cranking and starting will not be possible while any one, or more, of engine fault conditions lamps is lit, with the exception of "Not in Auto" illuminated in the manual mode. The following apply:

- A "lamp ON" condition indicates that fault condition has been "latched" by DC control/latch-crank circuit board.
- If any one of the lamps is ON (fault condition latched), the engine cannot be cranked either manually or automatically.
- To unlatch a fault (that is, to turn a lamp OFF) and permit cranking, push the Test/Reset switch in. The lamp will then go OFF, allowing for additional cranking.

◆ 1.5.1 NOT IN AUTOMATIC START MODE LAMP

This lamp comes ON to indicate that automatic startup of the engine is not possible. The lamp lights up whenever the Auto/Off/Manual switch is set to OFF or MANUAL.

◆ 1.5.2 OVERCRANK LAMP

The control console houses a DC control/latch-crank circuit board (the "C" board) that controls engine startup and shutdown. During automatic startup, the engine cranks for about 14 seconds, rests for about eight seconds, and so on, until eight crank-rest cycles have occurred. At the end of eight attempts, cranking stops, and the overcrank lamp goes ON.

◆ 1.5.3 HIGH COOLANT TEMPERATURE LAMP

This lamp comes ON if coolant temperature is too high or coolant level is too low. The engine shuts down automatically when such unsafe conditions occur. The following apply:

- If the engine is started with an existing high coolant temperature or low coolant level condition, the engine shuts down, and the lamp comes ON when engine speed reaches about 1000 rpm.
- If the engine starts normally but high temperature/low coolant level develops later, the engine shuts down, and the light comes ON immediately.

◆ 1.5.4 OVERSPEED LAMP

An engine overspeed above a safe limit causes the engine to automatically shut down, which turns ON the indicator lamp. The overspeed lamp comes on when the unit is run at a 15% faster rpm than rated.

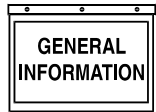

◆ 1.5.5 LOW OIL PRESSURE LAMP

This lamp lights up (latches) to indicate low oil pressure in the engine as follows:

- During cranking, after engine has reached 800 to 1000 rpm, the circuit allows four seconds for oil pressure to build.
- In auto mode, if the unit runs above 800-1000 rpm for more than four seconds, and oil pressure is below a safe level, the engine shuts down, but the lamp does NOT go ON. The system then actuates eight restart attempts; the engine shuts down, and the lamp goes ON.
- If the engine starts normally with good oil pressure, but oil pressure drops later, the system waits five seconds for oil pressure to be restored. If pressure is still low after a five-second delay, the engine shuts down, and the lamp goes ON immediately.

◆ 1.5.6 RPM SENSOR LOSS LAMP

Units with the "C" Option console are equipped with an rpm sensor, which is mounted directly over the engine flywheel gear teeth. This sensor is a magnetic pickup that emits an electrical pulse at the passage of each flywheel gear tooth. Sensor electrical signals are used by the DC control/latch-crank circuit board as engine speed (rpm) signals. The circuit board uses these rpm signals (a) to establish a starter lockout speed, and (b) to shut down the engine if the engine runs too fast (overspeed). If the rpm signals to the circuit board are lost, engine shutdown occurs, but the lamp will not light, (i.e., the condition will not latch), then, depending on whether the sensor signal loss occurred during a manual or an automatic start attempt, the following events occur:

► Manual Startup

If the engine starts within two seconds after cranking begins, shutdown occurs as soon as the Start/Stop switch is released, but without a lamp ON condition (latching does not occur). If engine does not start within two seconds after cranking begins, which disables starting, the rpm sensor loss light goes ON.

► Automatic Startup

The engine recranks within about one second after it has stopped. If sensor loss persists, engine shuts down, and lamp lights about two seconds after cranking has restarted.

If engine starts within two seconds after recrank has begun, the starter remains engaged until the two-second delay is over.

◆ 1.5.7 TEST/RESET SWITCH

To test all lamps, push this switch in. Following any fault shutdown with any monitor panel lamp illuminated, engine cranking is inhibited. To reset the system (unlatch a fault) and crank the engine again, push the switch in (lamp must go out). If the switch is actuated with the engine running, only the lamps will be tested. The engine will not shut down.

NOTE:

If engine shuts down due to some unmonitored problem (such as, out of fuel or failed ignition system), none of the lamps will come ON. If such an unmonitored shutdown occurs with the Auto/Off/Manual switch set to AUTO, engine recranks and attempts to start for any of the cycles remaining in the eight-crank limit. After all eight crank cycles have been used, the engine shuts down, and the OVERCRANK lamp goes ON.

1.6 OPTIONAL ANNUNCIATOR PANEL

Some units may come equipped with a factory-installed annunciator panel having up to nine annunciated fault conditions displayed (Figure 1.2). This optional panel is often called a "prealarm" panel, since it warns of impending problems before an actual fault shutdown occurs.

The panel is designed to monitor various engine condition-sensing devices having normally-open (N.O.) or normally-closed (N.C.) contacts.

Figure 1.2 — Optional Annunciator (Prealarm) Panel

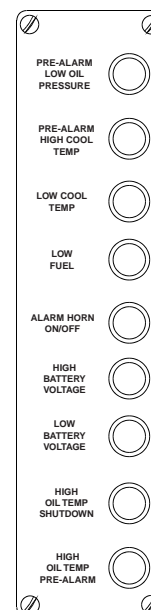

1.7 OPTIONAL REMOTE ANNUNCIATOR

An optional 18-light REMOTE annunciator panel that can be mounted on a wall (Figure 1.3) is also available. For information on the remote annunciator panels, ask the local dealer/distributor or consult the factory. Ask for information on the Models 9555 and 9556 remote annunciator panels. The following apply to the remote annunciator panels:

- It is designed for use with installation having a Generac Power Systems GTS-type transfer switch and a "C" Option control panel.
- The panel is available in both flush-mounted (Model 9556) and surface-mounted (Model 9555) configurations.
- The panel has a built-in audible alarm horn, with a reset switch to turn off the horn without disturbing the lighted indication.
- Remote monitoring of the standby generator set provides enough information to avoid unnecessary maintenance trips to the generator site.

Figure 1.3 — Optional 18-Light Remote Annunciator

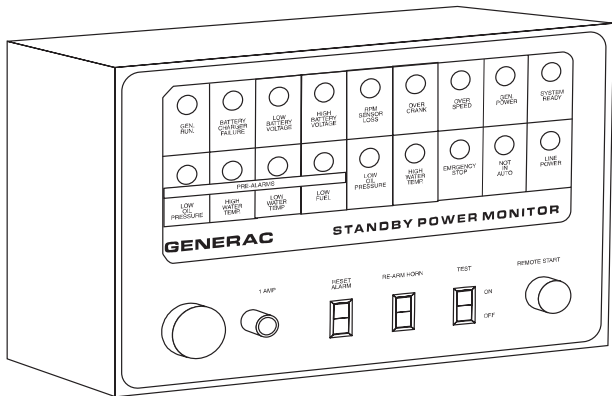

1.8 STANDARD ALARM RELAY

The generator's DC control/latch-crank circuit board is equipped with an alarm relay "driver". All units with "C" Option control panels are equipped with an alarm relay that is connected to the circuit board driver (Figure 1.4). If any one or more of the five annunciated shutdown faults occur, the circuit board driver energizes the optional alarm relay.

A remote-mounted alarm or annunciator device may be connected across the relay contacts so that a failure will turn on the remote alarm or device. The connected alarm device may range from an alarm horn to a warning light to a telephone dialer with a pre-recorded message. The alarm relay normally-open, normally-closed, and common contacts are shown in Figure 1.4.

Figure 1.4 — Standard Alarm Relay

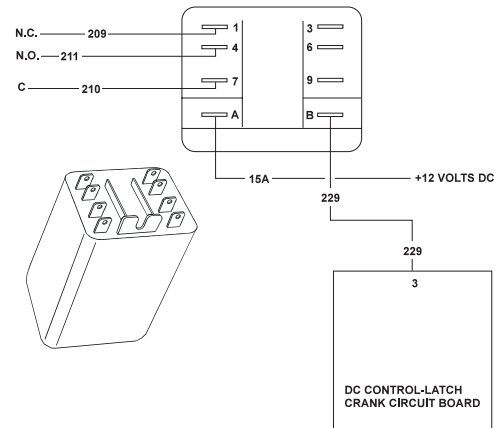

1.9 PREPARATION BEFORE STARTUP

The instructions in this section assume that the standby generator has been properly installed, serviced, tested, adjusted, and otherwise prepared for use by a competent, qualified installation contractor. Be sure to read RULES FOR SAFE OPERATION on the inside of the front cover carefully, before attempting to operate this (and related) equipment.

◆ 1.9.1 PRIOR TO INITIAL STARTUP

Before starting the generator for the first time, the installer must complete the following:

- Properly locate and properly mount the generator, transfer switch, and other standby system components, in strict compliance with applicable codes, standards, and regulations.
- Make sure the fuel supply system to the generator (a) delivers the correct fuel at the correct pressure, and (b) is properly purged and leak-tested according to code. No fuel leakage is permitted.
- Have the engine crankcase properly filled to the correct level with the recommended oil.
- Have engine cooling system properly filled with recommended coolant mixture. Check the system for leaks and other problems.
- If engine is equipped with a mechanical governor, make sure the governor is properly filled with oil. Use crankcase oil to fill.
- Check engine v-belt tension and belt condition.
- Make sure the generator is properly connected to an approved earth ground.
- The generator battery must be fully charged, properly installed and interconnected, and ready for use.

◆ 1.9.2 STARTUP INSPECTION

A standard, three-part form entitled “Startup Inspection for Standby Power Systems” (Part No. 67377) must be completed by the installation technician or engineer in order to activate warranty. As stated on the form, inspections are to be performed only by factory-trained personnel. The installer must complete the form and distribute copies as follows:

- White copy: Mail to Generac Service Department, P.O. Box 310, Eagle, WI 53119.
- Pink copy: For service file of installing dealer.
- Yellow copy: For the customer’s records.

2.1 OPERATING UNIT WITH MANUALLY OPERATED TRANSFER SWITCH

If the generator was installed with a transfer switch capable of manual operation only, the following applies: A manually-operated transfer switch is one that will not provide automatic startup and does not include the intelligence circuit, which comprises of a utility voltage sensor PCB, an inphase monitor PCB, a seven day exerciser PCB, or other type of sensing circuits found in a Closed Transition Transfer Switch (CTTS) or a Bypass Isolation Switch (BIS).

2.2 OPERATING UNIT WITH AUTOMATIC TRANSFER SWITCH

If the generator has been installed with a Generac “GTS”-type automatic transfer switch, the engine may be started and stopped either automatically or manually.

IMPORTANT: BE SURE TO READ THE APPLICABLE AUTOMATIC TRANSFER SWITCH MANUAL CAREFULLY. DIFFERENCES EXIST BETWEEN TRANSFER SWITCHES.

◆ 2.2.1 MANUAL STARTUP AND TRANSFER

To crank and start the engine and to transfer electrical loads to the STANDBY power source, proceed as follows:

- See applicable transfer switch instructions. If so equipped, set the Safety Disconnect Switch to MANUAL.
- On the generator’s Meter and Control Panel, set the Auto/Off/Manual switch to MANUAL.



The safety disconnect switch and the Auto/Off/Manual switches must be set as instructed above, or the generator will crank and start as soon as the utility power to the transfer switch is turned OFF.

- Turn OFF both the NORMAL (utility) and EMERGENCY (standby) power supplies to the transfer switch, using whatever means is provided (such as the main-line circuit breaker(s)).



DO NOT attempt manual operation until all power voltage supplies to the transfer switch have been positively turned OFF; otherwise, extremely dangerous---possibly lethal---electrical shock will result.

- Refer to the instructions that correspond to the installed transfer switch. Manually actuate the switch main contacts to their STANDBY (emergency) position, as outlined in the corresponding manual. LOAD circuit must be connected to the STANDBY power supply before proceeding.
- On the generator console, hold the Start/Stop switch START to crank the engine. Hold it until it begins running, then release the switch to its centered (RUN) position.
- Let the engine warm up and stabilize at no-load.
- Turn ON the STANDBY power supply to the transfer switch, using whatever means provided (such as STANDBY source main-line circuit breaker).
- The generator will now power the load circuits.

◆ 2.2.2 MANUAL RETRANSFER AND ENGINE SHUTDOWN

To retransfer LOAD circuits back to the NORMAL (utility) power source and to stop the engine, proceed as follows:

- Turn OFF both the UTILITY and STANDBY power supplies to the transfer switch, using whatever means provided, such as the main-line circuit breaker(s).



DO NOT attempt manual operation until all power voltage supplies to the transfer switch have been positively turned OFF; otherwise, extremely dangerous---possibly lethal---electrical shock will result.

- Refer to the applicable transfer switch instructions. Manually actuate the transfer switch main contacts to their utility position (LOAD connected to UTILITY power supply).
- Turn ON the UTILITY power supply to the transfer switch, using whatever means are provided (such as the UTILITY main-line circuit breaker(s)).
- Check that the UTILITY voltage is available to the transfer switch (see appropriate transfer switch instructions).
- Let the generator engine run at no-load for a few minutes. Then, set the generator Start/Stop switch to STOP. Wait for the engine to come to a complete stop.
- Reset the system for fully automatic operation.

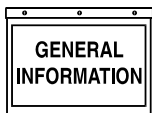

◆ 2.2.3 PREVENTING AUTOMATIC STARTUP



 When installed with an automatic transfer switch, Generac standby generators can crank and start suddenly, without warning, when UTILITY source voltage drops below a preset value. To prevent possible injuries caused by such sudden starts, disable the automatic transfer switch before working on, or around, the generator. Use any one, or more, of the following methods to disable the automatic start function:

- Set the generator's Auto/Off/Manual switch to OFF. Neither a manual nor an automatic start can be accomplished with this switch set to OFF.
- Remove the fuse from the generator control panel. To remove the fuse, push fuse holder cap in and turn cap counterclockwise. Remove cap and fuse element.
- Refer to the automatic transfer switch instructions. If the transfer switch is so equipped, set its Safety Disconnect switch to MANUAL position to prevent automatic startup and transfer.
- Disconnect battery cable from generator battery post, indicated by a negative, NEG, or (-).

Appendix 1 – Electrical Data

“C” Option Control Panel 24 Volt, 400 kW and Larger Interconnection Diagram – Drawing No. A7296-B

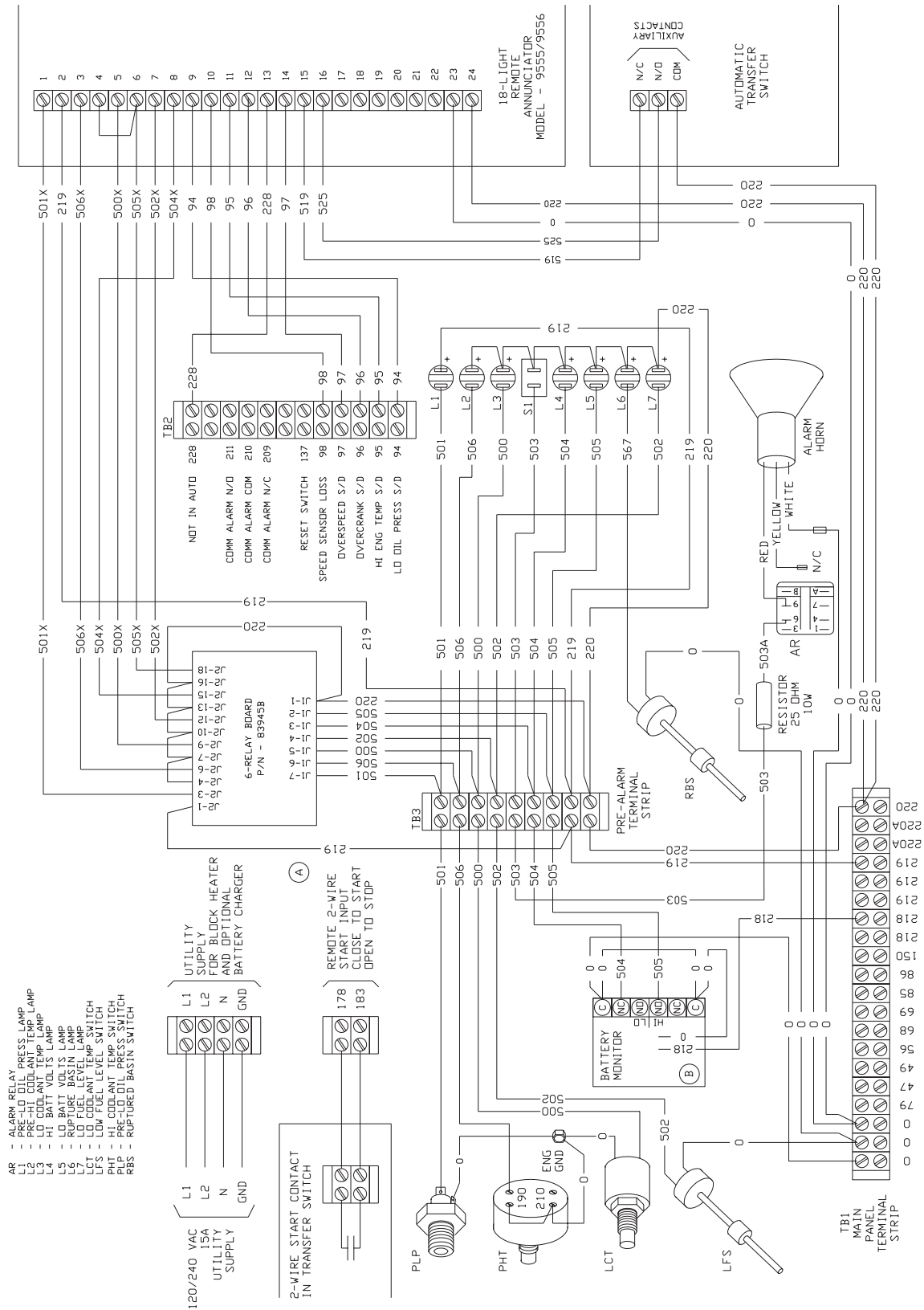
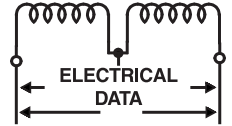

Appendix 1 – Electrical Data

"C" Option Control Panel 24 Volt, 400 kW and Larger

Wiring Diagram – Drawing No. A4723-B

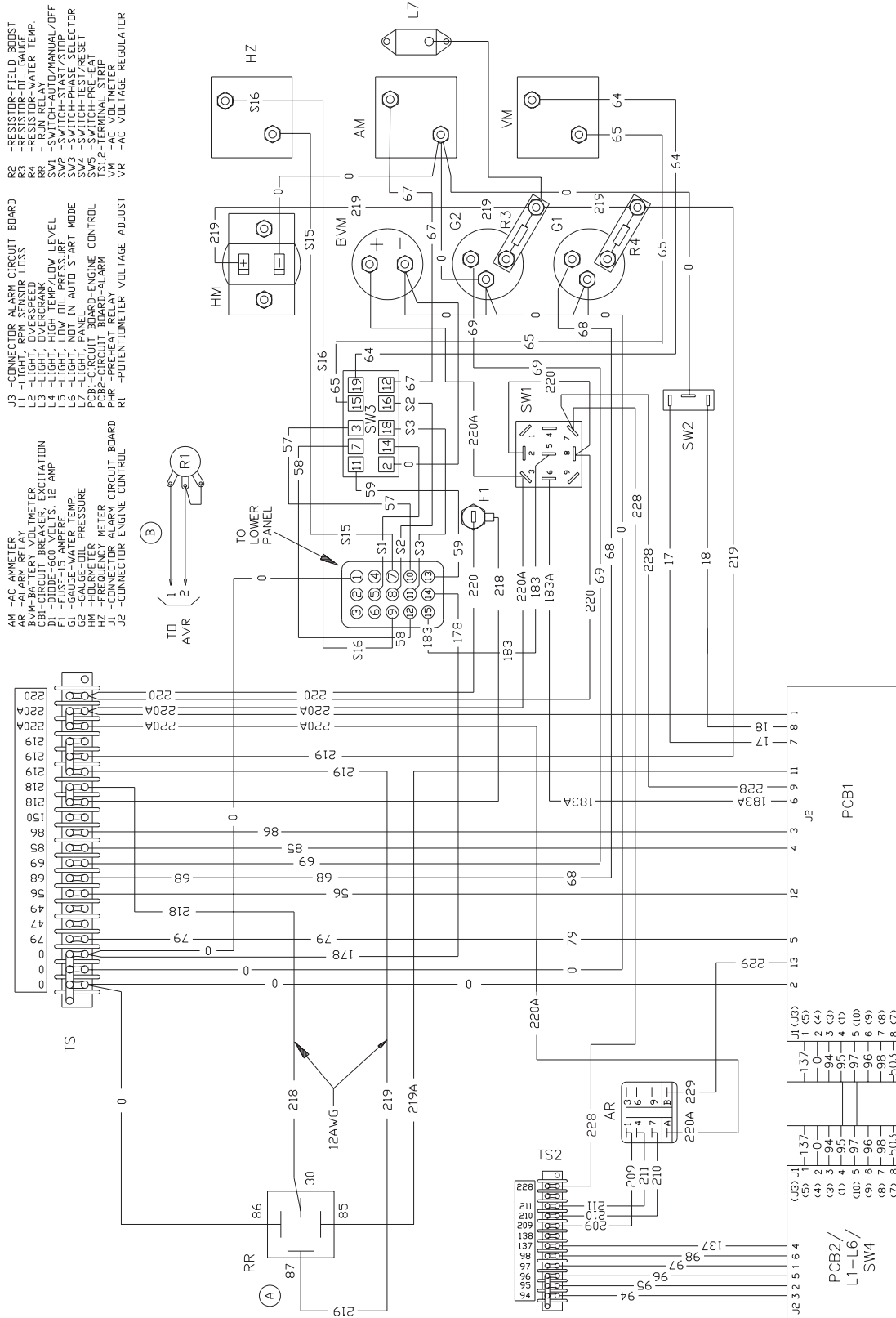
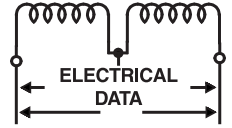

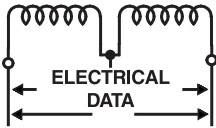

Appendix 1 – Electrical Data

"C" Option Control Panel 24 Volt Diesel, Less than 400 kW Control Panel Electrical Schematic - Drawing No. 84850-C

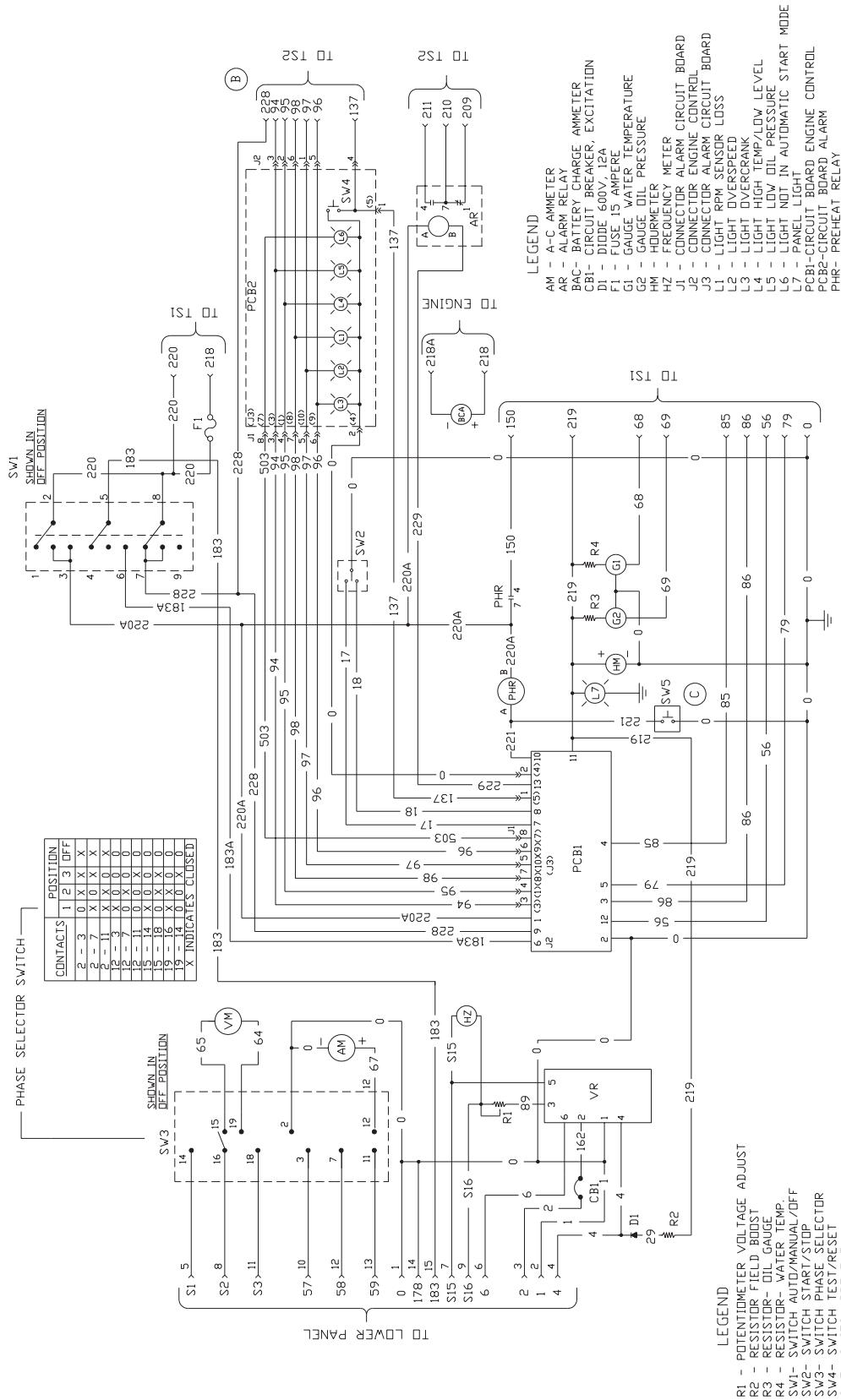

Appendix 1 – Electrical Data

“C” Option Control Panel 24 Volt Diesel, Less than 400 kW Control Panel Wiring Diagram – Drawing No. 84849-C

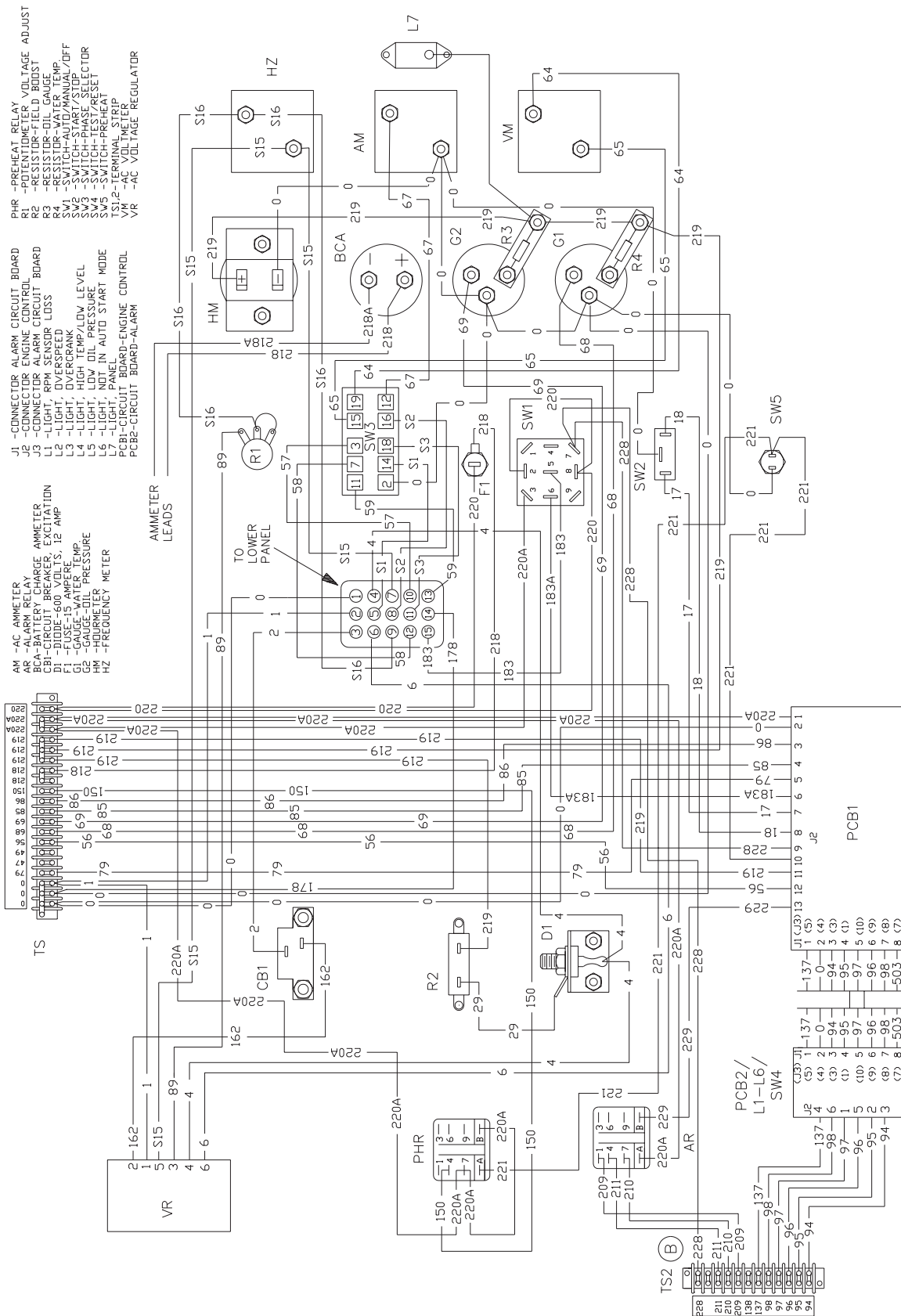
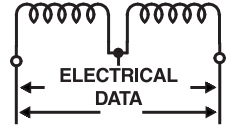

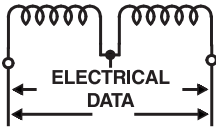

Appendix 1 – Electrical Data

"C" Option Control Panel 12 Volt Gas Control Panel Electrical Schematic – Drawing No. 85023-A

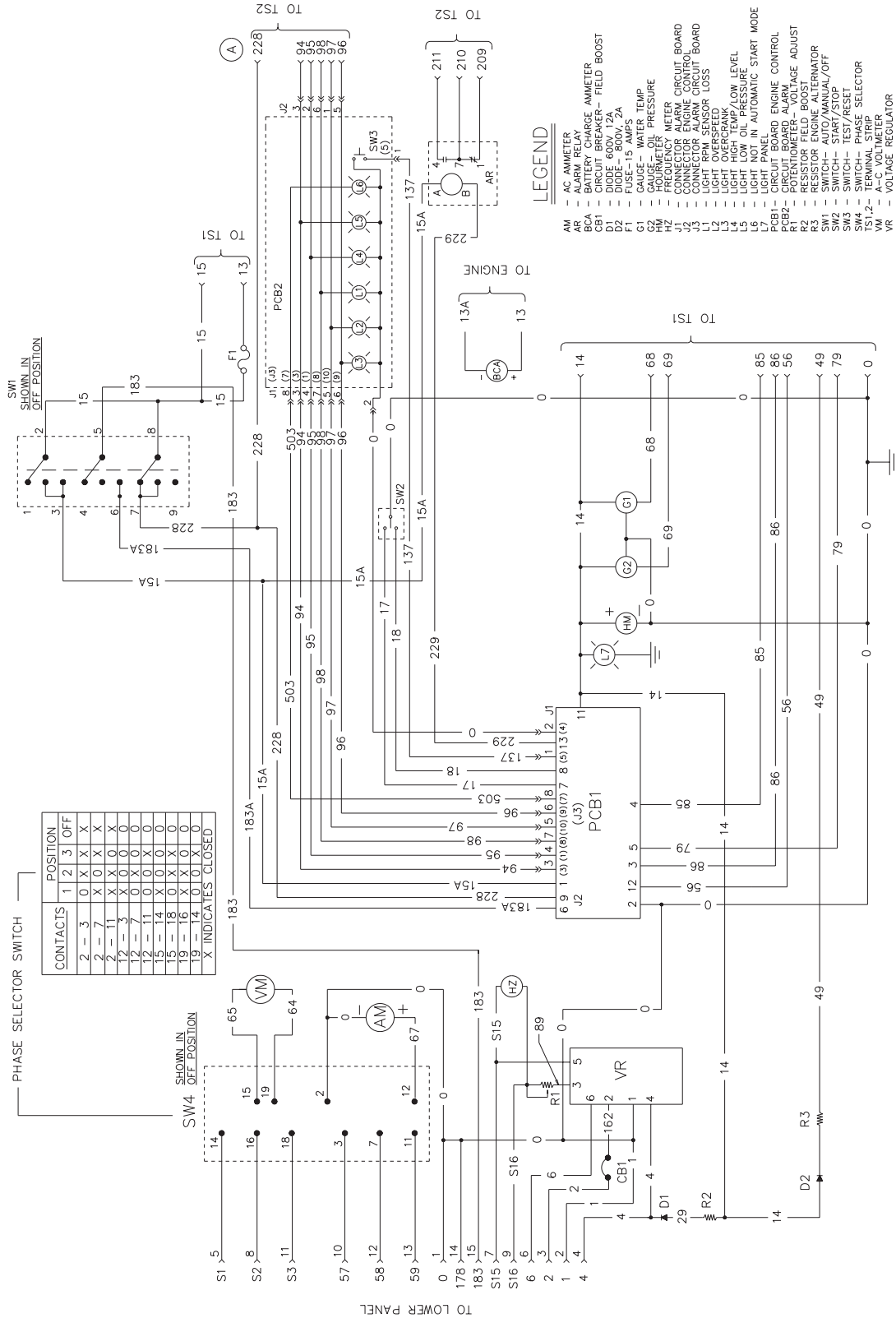

Appendix 1 – Electrical Data

“C” Option Control Panel 12 Volt Gas

Control Panel Wiring Diagram – Drawing No. 85024-A

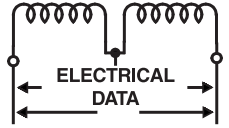

LEGEND

- | | | | |
|-----|----------------------------------|-------|---------------------------------|
| AM | — AC AMMETER | L4 | — LIGHT HIGH TEMP/LOW LEVEL |
| AR | — ALARM RELAY | L5 | — LIGHT LOW OIL PRESSURE |
| CB1 | — CIRCUIT BREAKER— FIELD BOOST | L7 | — LIGHT PANEL |
| D1 | — DIODE— 600V, 12A | PCB1 | — CIRCUIT BOARD ENGINE CONTROL |
| D2 | — DIODE— 800V, 2A | PCB2 | — CIRCUIT BOARD ALARM |
| F1 | — FUSE— 15 AMPS | R1 | — POTENTIOMETER— VOLTAGE ADJUST |
| G1 | — GAUGE— WATER TEMP | R2 | — RESISTOR— FIELD BOOST |
| G2 | — GAUGE— OIL PRESSURE | SW1 | — SWITCH— AUTO/MANUAL/OFF |
| J1 | — CONNECTOR ALARM CIRCUIT BOARD | SW2 | — SWITCH— TEST/RESET |
| J2 | — CONNECTOR ENGINE CIRCUIT BOARD | SW3 | — SWITCH— START/STOP |
| L1 | — LIGHT RPM SENSOR LOSS | SW4 | — SWITCH— PHASE SELECTOR |
| L2 | — LIGHT OVERSPEED | TS1,2 | — TERMINAL STRIP |
| L3 | — LIGHT OVERCRANK | VM | — A-C VOLTMETER |
| VR | — VOLTAGE REGULATOR | | |

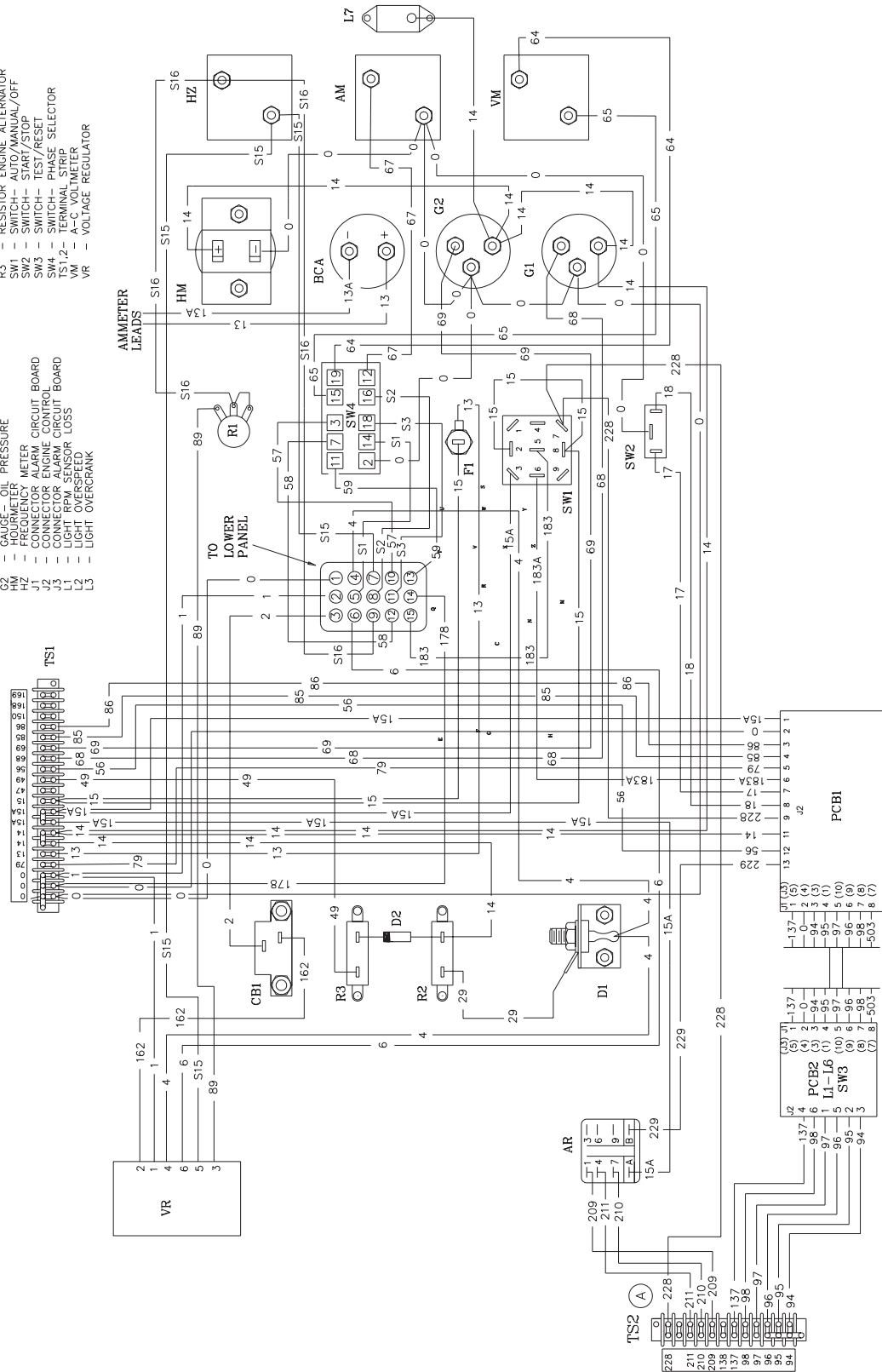

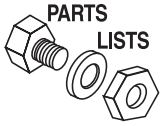

Appendix 2 – Exploded Views and Parts Lists

"C" Option Control Panel 24 Volt Diesel Control Panel – Drawing No. 84851-J

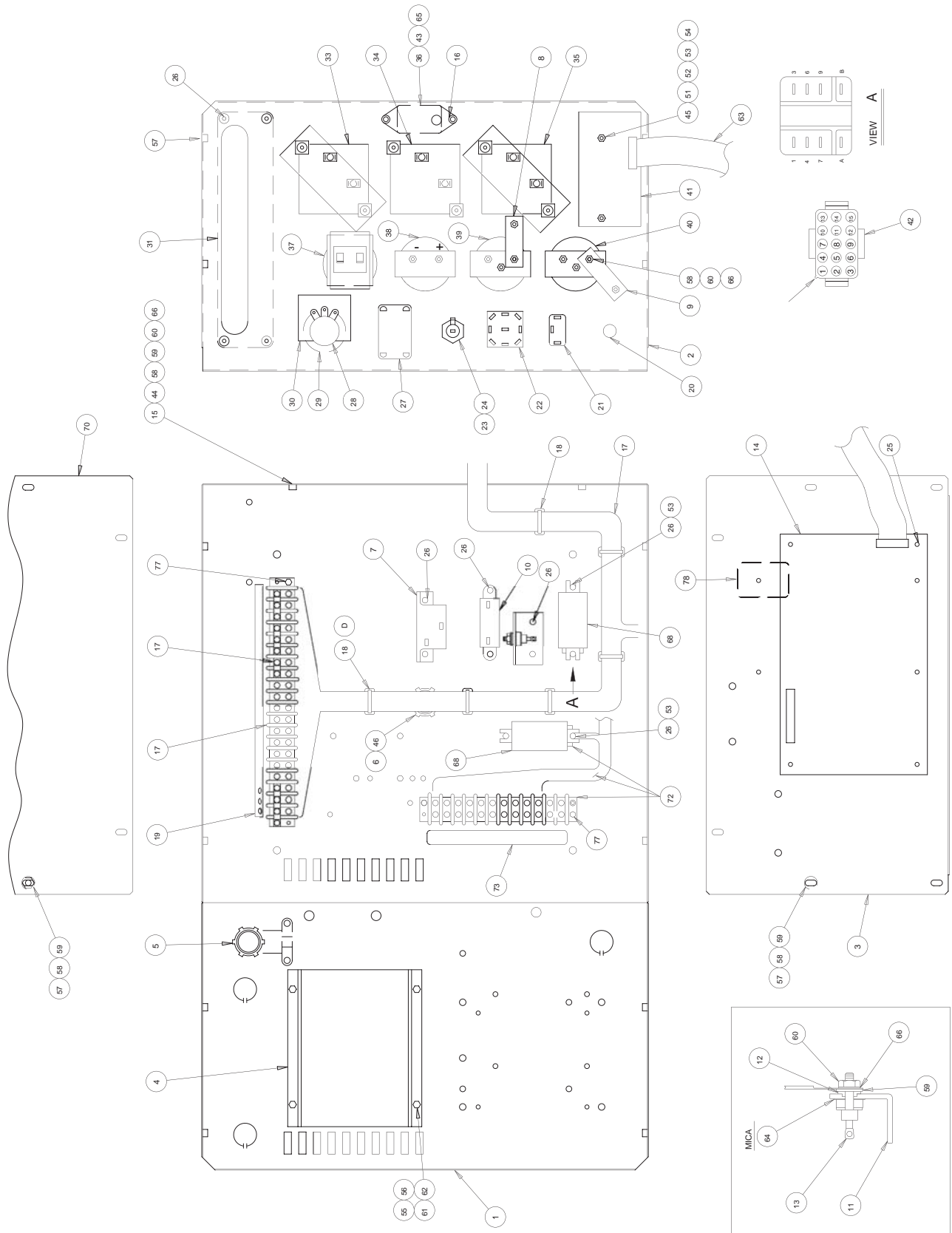

Appendix 2 – Exploded Views and Parts Lists

"C" Option Control Panel 24 Volt Diesel Control Panel – Drawing No. 84851-J

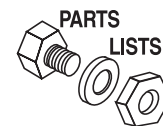

ITEM	PART NO.	QTY.	DESCRIPTION	ITEM	PART NO.	QTY.	DESCRIPTION
1	070023	1	CONTROL PANEL BOTTOM	37	070081	1	HOURMETER
2	070026	1	SLKSCRND PANEL FRONT	38	062304	1	AMMETER 40-0-40 DC
3	070028	1	COVER CON PNL SIDE	39	055405	1	GAUGE OIL PRESSURE
4	067680	1	ASSY VOLTAGE REGULATOR 60HZ	40	055406	1	GAUGE COOLANT TEMPERATURE
	092952	1	ASSY VOLTAGE REGULATOR 50HZ	41	070083	1	ASSY PCB ENGINE MONITOR
5	039271	1	FITTING 90 DEGREE 3/4	42	055089	1	CONN PLUG PNL 15P AMP M-N-L
6	034616	1	FITTING STRAIGHT 3/4	43	070082	1	BLOCKER LIGHT
7		1	CIRCUIT BREAKER	44	053247	1	LUG RNGTNG INS 22-18 X10 X.322
8	082985	1	RES 100R 5% 5W ASSY=55405	45	029187	2	SPACER .19 X .31 X .50 PL
9	082984	1	RES 120R 10% 2W ASSY 55406	46	077043B	1	FLEX CONDUIT .50 ID
10	086266	1	RES WW LUG 75R 5% 25W	50	036904	4	SCREW PPHM #6-32 X 3/4 (NOT SHOWN)
11	055444	1	HEATSINK	51	036908	2	SCREW PPHM #6-32 X 1-1/4
12	030468	1	WASHER STEP NYLON .20	52	022155	2	WASHER LOCK #6
13	049939	1	RECTIFIER MSC 12A 600V 1N1206R	53	022985	6	WASHER FLAT #6 ZINC
14	083089	1	ASSY PCB "C" CONTROL 12/24V	54	022188	2	NUT HEX #6-32 STEEL
15	033147	1	SCREW HHM #10-32 X 1	55	036918	4	SCREW PPHM #8-32 X 1/2
16	024469	2	SCREW HHTT #10-32 X 3/8 CZ	56	022264	4	WASHER LOCK #8-M4
17	084853A	1	HARNESS F/<100KW 24V C DIESEL	57	033121	16	SCREW HHC #10-32 X 1/2
	084853B	1	HARNESS F/>101KW 24V C DIESEL	58	022152	26	WASHER LOCK #10
	084853C	1	HARNESS F/12LMITS 24V C DIESEL	59	023897	14	WASHER FLAT #10 ZINC
18	029333	6	TIE WRAP 7.4"X.19" NATL UL	60	022158	20	NUT HEX #10-32 STEEL
19	084875	1	DECAL TERMINAL STRIP	61	038150	4	WASHER FLAT #8 ZINC
20	055920	1	SWITCH SPST SPADE PNL MNT	62	022471	4	NUT HEX #8-32 STEEL
21	055867	1	SWITCH TOG SPDT 15A SPD MOM	63	084787	1	CABLE RIBBON 16"
22	067625	1	SWITCH TOGGLE 3P3T 15/10A	64	070370	2	WASHER MICA .203
23	032300	1	HOLDER FUSE	65	083288	1	LIGHT 28VDC .17A MIN BAYNT MNT
24	022676	1	FUSE 15A X AGC15	66	023762	4	WASHER SHAKEPROOF EXT #10 STL
25	040213	4	PCB SUPPORT SNAP-IN 1/4"	68	081767	2	RELAY PNL 24VDC DPDT 10A
26	0C2428	14	SCREW PHTT #6-32 X 1/2 ZYC	70	064000	1	CONTROL PNL SIDE
27	061945	1	SWITCH SELECTOR 6A AMP/V	71	064008	1	COVER CON PNL TOP
28	071361	1	POT 5K 10% 2.25W PNL	72	098940	1	HARNESS C-OPT CTRL PNL
29	050123	1	KNOB PLASTIC .25 SHAFT	73	066040	1	DECAL - TERM STRIP
30	055349	1	INSULATOR	77	0C2323	4	SCREW PHTT #6-32 X 5/8 ZYC
31	070030	1	COVER GENERAC SILKSCREENED	78	0C1229	1	DECAL CUST CONN BOX
33	070042	1	FREQUENCY METER 240V 55-65HZ	79	022507	4	SCREW HHC 1/4-20 X 1/2 G5 (NOT SHOWN)
	070042-A	1	FREQUENCY METER 240V 45-55HZ				
34		1	AC AMMETER	80	022097	8	WASHER LOCK M6-1/4 (NOT SHOWN)
35		1	AC VOLTMETER	81	040479	4	VIB MNT 1.0 X 1.0 X 1/4-20 (NOT SHOWN)
36	083287	1	LIGHT HLDR CLR LNS W/O BULB				

Appendix 2 – Exploded Views and Parts Lists

**"C" Option Control Panel 24 Volt Gas
Control Panel – Drawing No. 84711-N**

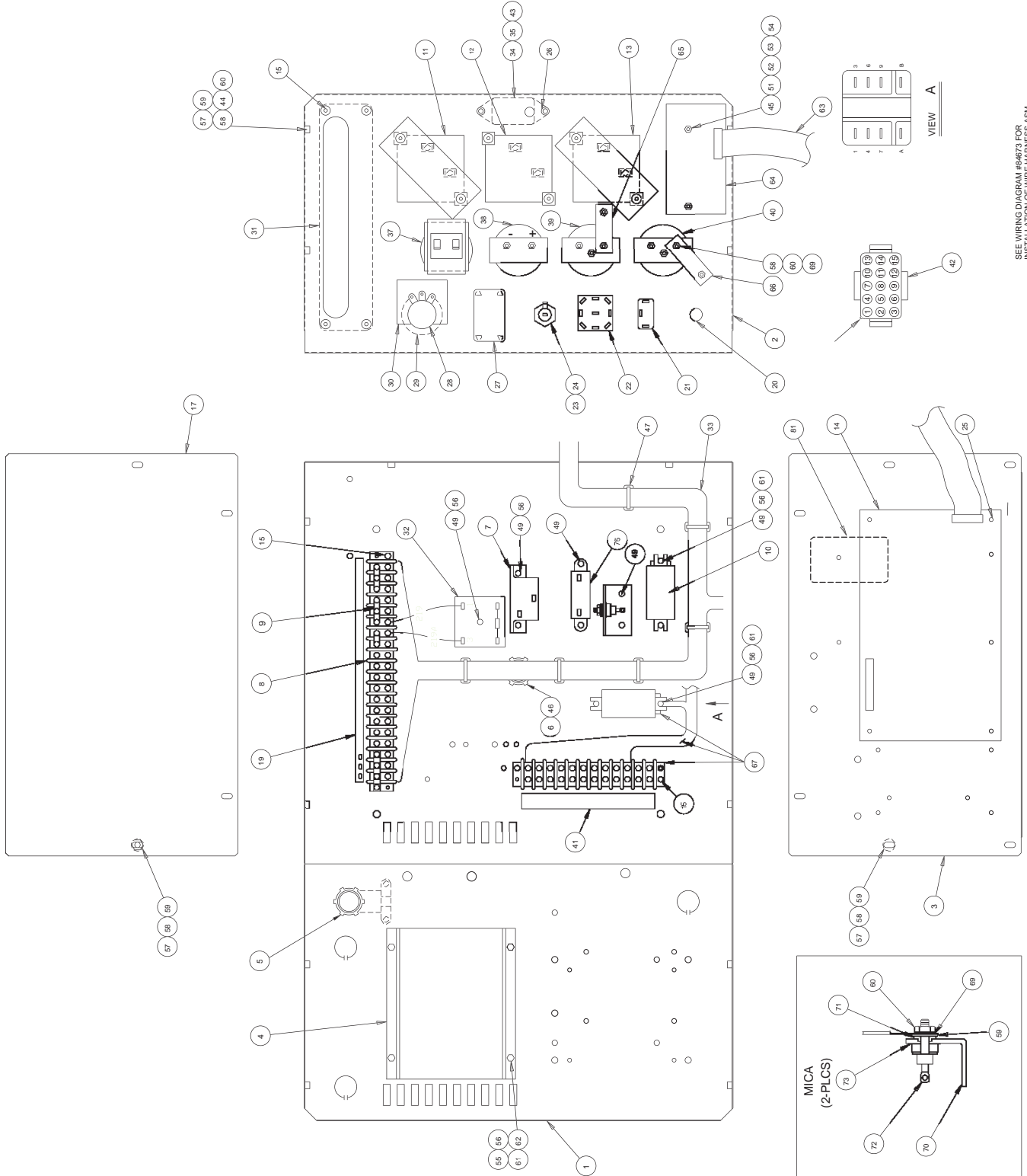

SEE WIRING DIAGRAM #84711-FPC
FOR
INSTALLATION OF WIRE HARNESS ASM.

Appendix 2 – Exploded Views and Parts Lists

"C" Option Control Panel 24 Volt Gas Control Panel – Drawing No. 84711-N

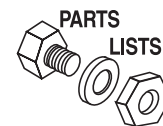

ITEM	PART NO.	QTY.	DESCRIPTION	ITEM	PART NO.	QTY.	DESCRIPTION
1	070023	1	CONTROL PANEL BOTTOM	32	* 084717	1	ASSEMBLY TIME RELAY
2	070026	1	CONTROL PANEL FRONT	33	084733	1	HARNESS CONTROL PANEL C
3	070028	1	CONTROL PANEL SIDE	34	083287	1	LIGHT HLDR CLR LNS W/O BULB
4	067680	1	REGULATOR ASSEMBLY VOLTAGE B&D	35	083288	1	LIGHT 28V DC .17A MIN BAYNT MNT
5	039271	1	FITTING 90 DEGREE 3/4	37	070081	1	METER HOURS
6	034616	1	FITTING STRAIGHT 3/4	38	062304	1	AMMETER 40-0-40 DC
7	057159	1	CIRCT BRK 2 X 1 ETA 46-500-P	39	055405	1	GAUGE OIL PRESSURE
	053623	1	CIRCT BRK 2.5 X 1 ETA 46-500-P	40	055406	1	GAUGE COOLANT TEMPERATURE
	054502	1	CIRCT BRK 3 X 1 ETA 46-500-P	41	066040	1	DECAL TERMINAL STRIP
	056247	1	CIRCT BRK 3.5 X 1 ETA 46-500-P	42	055089	1	CONN ELEC AMP M-N-L 15 PLUG PNL
	049350	1	CIRCT BRK 4 X 1 ETA 46-500-P	43	070082	1	BLOCKER LIGHT
	048476	1	CIRCT BRK 4.5 X 1 AUT30KW CNT45K	44	053247	1	LUG RNGTNG INS 22-18 X 10 X .322
	048512	1	CIRCT BRK 5 X 1 ETA 46-500-P	45	029187	2	SPACER .19 X .31 X .50 ST/ZNC
	054450	1	CIRCT BRK 5.5 X 1 ETA 46-500-P	46	077043B	16"	FLEX CONDUIT .50 ID
	048505	1	CIRCT BRK 6 X 1 ETA 46-500-P	47	029333	6	TIE WRAP 7" WHITE
	048467	1	CIRCT BRK 7 X 1 ETA 46-500-P	49	0C2323	10	SCREW PHM SWAGE 6-32 X 5/8 Z/YC
	048468	1	CIRCT BRK 8 X 1 ETA 46-500-P	50	036904	2	SCREW PPHM #6-32 X 3/4 (NOT SHOWN)
	048470	1	CIRCT BRK 9 X 1 ETA 46-500-P	51	036908	2	SCREW PPHM #6-32 X 1-1/4
8	057335	1	BLOCK TERM 20A 20 X 6 X 1100V	52	022155	2	WASHER LOCK #6
9	046669	7	BLOCK TERM JUMPER FOR S141	53	022985	6	WASHER FLAT #6-M4
10	** 081767	1	RELAY PNL 24VDC DPDT 10A	54	022188	2	NUT HEX #6-32 STEEL
11	070042	1	METER FREQUENCY 55-65HZ	55	036918	4	SCREW PPHM #8-32 X 1/2
	070042A	1	METER FREQUENCY 240V 45-55HZ	56	022264	11	WASHER LOCK M4
12	070054	1	AMMETER AC 0 TO 50	57	033121	14	SCREW HHM 10-32 X 1/2
	070055	1	AMMETER AC 0 TO 100	58	022152	22	WASHER LOCK #10
	070056	1	AMMETER AC 0 TO 150	59	023897	15	WASHER FLAT #10 ZINC
	070045	1	AMMETER AC 0 TO 200	60	022158	11	NUT HEX #10-32 STEEL
	070057	1	AMMETER AC 0 TO 300	61	038150	8	WASHER FLAT #8 ZINC
	070058	1	AMMETER AC 0 TO 400	62	022471	4	NUT HEX #8-32 STEEL
	070059	1	AMMETER AC 0 TO 600	63	084787	1	CABLE RIBBON 16"
	070060	1	AMMETER AC 0 TO 800	64	070083	1	ASSEMBLY ENGINE MONITOR
13	070043	1	METER VOLT AC 0-300	65	082985	1	ASSEMBLY RESISTOR 68 OHM 5W
	070044	1	METER VOLT AC 0-600	66	082984	1	ASSEMBLY RESISTOR 120 OHM 2W
14	083089	1	ASSY BOARD "C" CONTROL 12/24V	67	098940	1	HARNESS C-OPT CTRL PNL
15	0C2428	8	SCREW TAPTITE PH #6-32 X 1/2 ZYC	69	023762	3	WASHER SHAKEPROOF EXT #10 STL
17	064000	1	CONTROL PANEL SIDE	70	055444	1	SINK HEAT
18	064008	1	COVER CONTROL PANEL TOP (NOT SHOWN)	71	030468	1	WASHER STEP NYLON .20
19	084736	1	DECAL TERMINAL STRIP	72	049939	1	RECTIFIER MSC 12A 600V 1N1206R
20	026536	1	PLUG STEEL 0.5	73	070370	2	WASHER MICA .203
21	055867	1	SWITCH SPDT 15A SPD TGGL MOM	75	086266	1	RESISTOR WW LUG 75R 5% 25W
22	067625	1	SWITCH 3P TRIP THR 15/10A TGGL	76	022507	4	SCREW HHC 1/4-20 X 1/2 G5 (NOT SHOWN)
23	032300	1	HOLDER FUSE	77	022097	8	WASHER LOCK M6-1/4 (NOT SHOWN)
24	022676	1	FUSE 15A X AGC15	78	040479	4	MOUNT VIBR 1.0 X 1.0 X 1/4-20 (NOT SHOWN)
25	040213	4	PCB SUPPORT SNAP-IN 1/4	79	0441140156	1	WIRE ASSY 18AWG #0 (NOT SHOWN)
26	024469	2	SCREW TAPTITE #10-32 X 3/8 BP	80	033147	1	SCREW HHM #10-32 X 1 (NOT SHOWN)
27	061945	1	SWITCH 6A AMP/V SELECTOR	81	0C1299	1	DECAL WARNING
28	071361	1	POTENTIOMETER 5K +/-10% 2.25W PNL				
29	050123	1	KNOB PLASTIC .25 SHAFT				
30	055349	1	INSULATOR				
31	070030	1	COVER GENERAC SILKSCREEN				

* USED ON 13.3L SPARK IGNITED ONLY

** USED ON 13.3L TURBO SPARK ONLY

Appendix 2 – Exploded Views and Parts Lists

**"C" Option Control Panel 12 Volt Diesel
Control Panel – Drawing No. 85027-H**

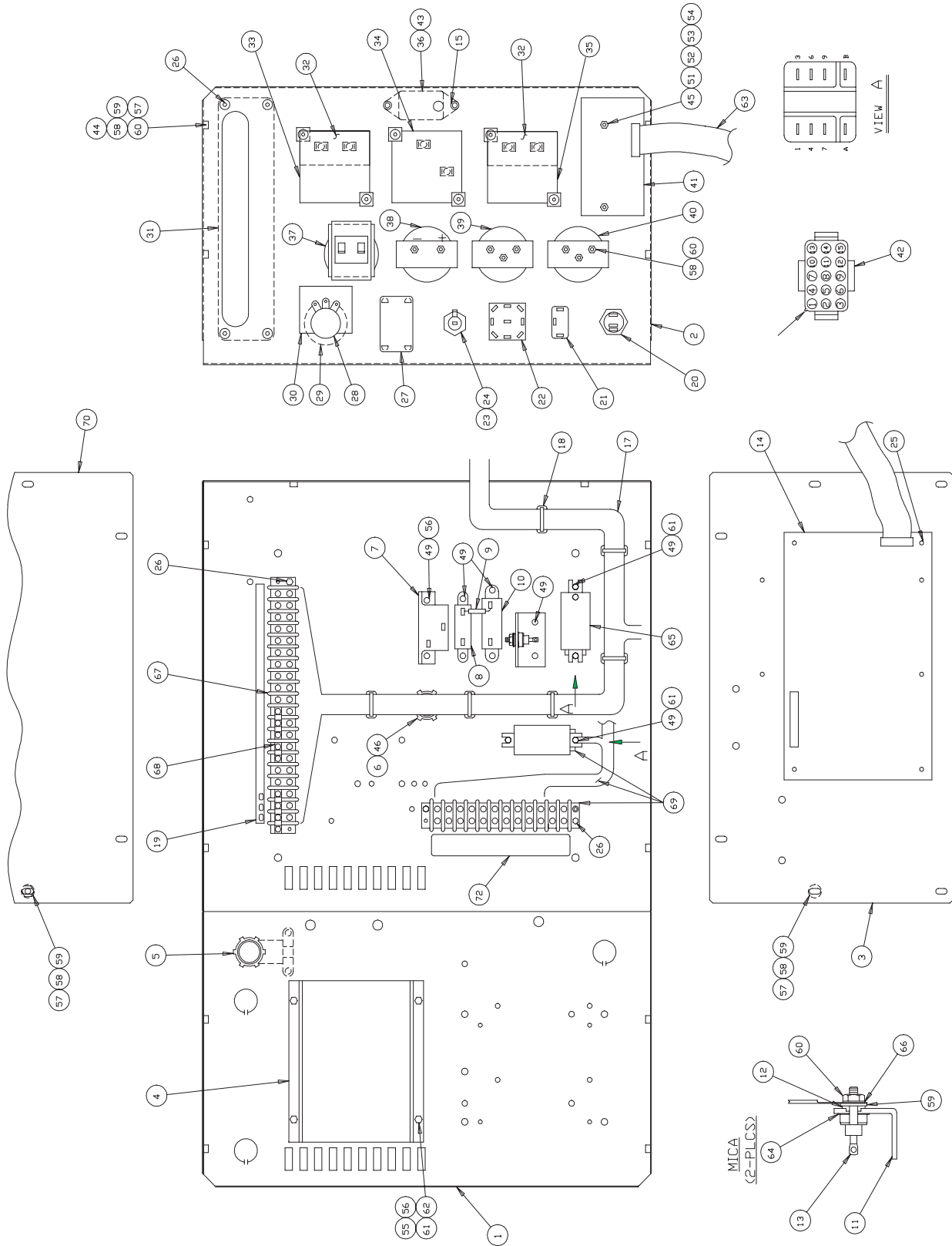

Appendix 2 – Exploded Views and Parts Lists

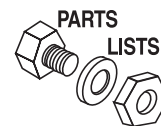

"C" Option Control Panel 12 Volt Diesel Control Panel – Drawing No. 85027-H

ITEM	PART NO.	QTY.	DESCRIPTION	ITEM	PART NO.	QTY.	DESCRIPTION
1	070023	1	CONTROL PANEL BOTTOM		070057	1	AMMETER AC 0 TO 300
2	070026	1	CONTROL PANEL FRONT		070058	1	AMMETER AC 0 TO 400
3	070028	1	CONTROL PANEL SIDE		070059	1	AMMETER AC 0 TO 600
4	067680	1	REGULATOR VOLT 60HZ		070060	1	AMMETER AC 0 TO 800
	092952	1	REGULATOR VOLT 50HZ	35	070043	1	METER VOLT AC 0 TO 300
5	039271	1	FITTING 90 DEGREE 3/4		070044	1	METER VOLT AC 0 TO 600
6	034616	1	FITTING STRAIGHT 3/4	36	070202	1	LIGHT PANEL
7	057159	1	CIRCT BRK 2 X 1 ETA 46-500-P	37	070081	1	METER HOURS
	053623	1	CIRCT BRK 2.5 X 1 ETA 46-500-P	38	062304	1	AMMETER 40-0-40 DC
	054502	1	CIRCT BRK 3 X 1 ETA 46-500-P	39	055405	1	GAUGE OIL PRESSURE
	056247	1	CIRCT BRK 3.5 X 1 ETA 46-500-P	40	055406	1	GAUGE COOLANT TEMPERATURE
	049350	1	CIRCT BRK 4 X 1 ETA 46-500-P	41	070083	1	ASSY ENGINE MONITOR
	048476	1	CIRCT BRK 4.5 X 1 AUT 30KW CNT45K	42	055089	1	CONN ELEC AMP M-N-L 15PLUG PNL
	048512	1	CIRCT BRK 5 X 1 ETA 46-500-P	43	070082	1	BLOCKER LIGHT
	054450	1	CIRCT BRK 5.5 X 1 ETA 46-500-P	44	053247	1	LUG RNGTNG INS 22-18 X 10 X .322
	048505	1	CIRCT BRK 6 X 1 ETA 46-500-P	45	029187	2	SPACER .19 X .31 X .50 ST/ZNC
	048467	1	CIRCT BRK 7 X 1 ETA 46-500-P	46	077043B	16"	FLEX CONDUIT .50 ID
	048468	1	CIRCT BRK 8 X 1 ETA 46-500-P	49	0C2323	12	SCREW PHM SWAGE 6-32X5/8 Z/YC
	048470	1	CIRCT BRK 9 X 1 ETA 46-500-P	51	036908	2	SCREW PPHM #6-32 X 1-1/4
8	044213	1	RESIST MISC 10R X 12W	52	022155	2	WASHER LOCK #6
9	025192	1	RECTIFIER MSC 2A 600V 1N5062	53	022985	2	WASHER FLAT #6
10	048352	1	RESIST MISC 5R X 25W	54	022188	2	NUT HEX #6-32 STEEL
	057907	1	RESISTOR WW LUG 10R 10% 25W	55	036918	4	SCREW HHM #8-32 X 1/2
	057405	1	RESIST MISC 25R X 25W	56	022264	6	WASHER LOCK M4
11	055444	1	HEAT SINK 13.3L	57	033121	14	SCREW HHM 10-32 X 1/2
12	030468	1	WASHER STEP NYLON .20	58	022152	20	WASHER LOCK #10
13	049939	1	RECTIFIER MSC 12A 600V 1N1206R	59	023897	12	WASHER FLAT #10
14	083089	1	BOARD "C" CONTROL 12/24V	60	022158	9	NUT HEX #10-32 STEEL
15	024469	2	SCREW TAPTITE #10-32X3/8 BP	61	038150	4	WASHER FLAT #8 ZINC
17	085058	1	HARNESS 12 VOLT DIESEL	62	022471	4	NUT HEX #8-32 STEEL
18	029333	6	TIE WRAP 7" WHITE	63	084787	1	CABLE RIBBON 16"
19	070097	1	DECAL TERMINAL STRIP	64	070370	2	WASHER MICA .203
20	055920	1	SWITCH 1PST PSADE PNL MNT	65	063617	1	RELAY PNL 12VDC DPDT 10A @ 240VA
21	055867	1	SWITCH SPDT 15A SPD TGGL MOM	66	023762	1	WASHER SHAKEPROOF EXT #10 STL
22	067625	1	SWITCH 3P TRIP THR 15/10A TGGL	67	057335	1	BLOCK TERM 20A 20 X 6 X 1100V
23	032300	1	HOLDER FUSE	68	046669	5	JUMPER TERMINAL BLOCK
24	022676	1	FUSE 15A X AGC15	69	098940	1	HARNESS C-OPTION CONTROL PANEL
25	040213	4	CONN PCB SUP SNAP-IN	70	064000	1	SIDE CONTROL PANEL
26	0C2428	8	SCREW TAPTITE PH #6-32 X 1/2 ZYC	71	064008	1	COVER CONTROL PANEL TOP (NOT SHOWN)
27	061945	1	SWITCH 6A AMP/V SELECTOR				
28	071361	1	POTENTIO PNL 5K +/-10% 2.25W	72	066040	1	DECAL TERMINAL STRIP
29	050123	1	KNOB PLASTIC .25 SHAFT	73	022507	4	SCREW HHC 1/4-20 X 1/2 G5 (NOT SHOWN)
30	055349	1	INSULATOR				
31	070030	1	COVER SILKSCREEN	74	022097	8	WASHER LOCK M6-1/4 (NOT SHOWN)
32	070080	2	INSULATOR	75	040479	4	MOUNT VIBR 1.00X1.00X1/4-20 (NOT SHOWN)
33	070042	1	METER FREQUENCY 55-65HZ				
	070042A	1	METER FREQUENCY 240V 45-55HZ	76	036904	2	SCREW PPHM #6-32 X 3/4 (NOT SHOWN)
34	070054	1	AMMETER AC 0 TO 50				
	070055	1	AMMETER AC 0 TO 100	77	0441140156	1	ASSY WIRE 18AWG #15 (NOT SHOWN)
	070056	1	AMMETER AC 0 TO 150	78	033147	1	SCREW HHM #10-32 X 1 (NOT SHOWN)
	070045	1	AMMETER AC 0 TO 200				

Appendix 2 – Exploded Views and Parts Lists

**"C" Option Control Panel 12 Volt Gas
Control Panel – Drawing No. 085026-J**

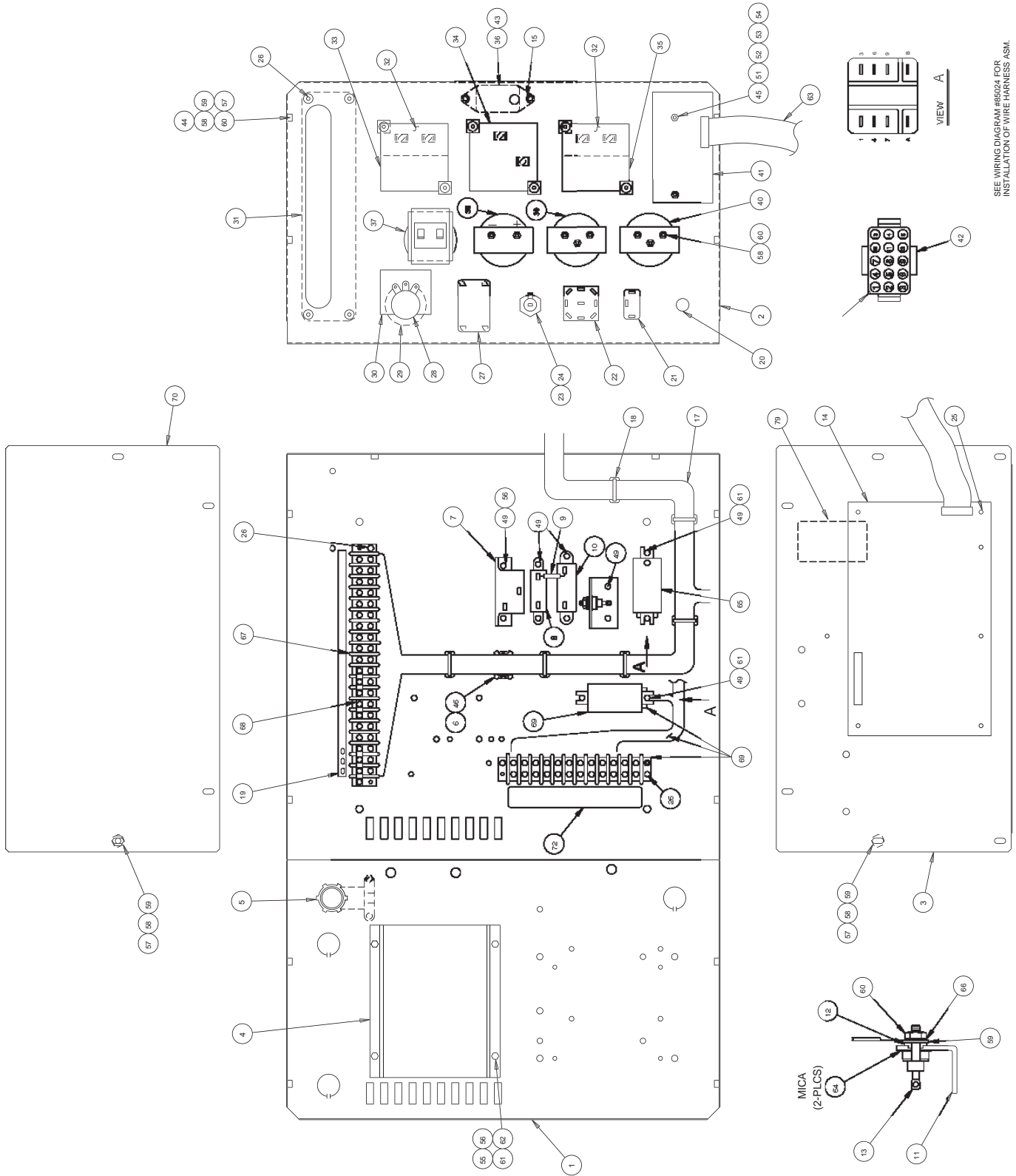

SEE WIRING DIAGRAM #85024 FOR
INSTALLATION OF WIRE HARNESS ASM.

Appendix 2 – Exploded Views and Parts Lists

"C" Option Control Panel 12 Volt Gas Control Panel – Drawing No. 085026-J

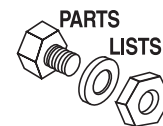

ITEM	PART NO.	QTY.	DESCRIPTION	ITEM	PART NO.	QTY.	DESCRIPTION
1	070023	1	PANEL BOTTOM CONTROL	070045	1	AC AMMETER-0 TO 200	
2	070026	1	PANEL FRONT CONTROL	070057	1	AC AMMETER-0 TO 300	
3	070028	1	PANEL SIDE CONTROL	070058	1	AC AMMETER-0 TO 400	
4	067680	1	REGULATOR ASSY VOLTAGE 60HZ	070059	1	AC AMMETER-0 TO 600	
	092952	1	REGULATOR ASSY VOLTAGE 50HZ	070060	1	AC AMMETER-0 TO 800	
5	039271	1	FITTING 90DEGREE ¾	35	070043	1	AC VOLTMETER-0 TO 300
6	034616	1	FITTING STRAIGHT ¾		070044	1	AC VOLTMETER-0 TO 600
7	057159	1	CIRCT BRK 2 X 1 ETA 46-500-P	36	070202	1	LIGHT PANEL #26306C
	053623	1	CIRCT BRK 2.5 X 1 ETA 46-500-P	37	070081	1	METER HOURS
	054502	1	CIRCT BRK 3 X 1 ETA 46-500-P	38	062304	1	AMMETER 40-0-40 DC
	056247	1	CIRCT BRK 3.5 X 1 ETA 46-500-P	39	055405	1	GAUGE OIL PRESSURE
	049350	1	CIRCT BRK 4 X 1 ETA 46-500-P	40	055406	1	GAUGE COOLANT TEMPERATURE
	048476	1	CIRCT BRK 4.5 X 1 AUT30KW CNT45K	41	070083	1	ASSY ENGINE MONITOR
	048512	1	CIRCT BRK 5 X 1 ETA 46-500-P	42	055089	1	CONN ELEC AMP M-N-L 15PLUG PNL
	054450	1	CIRCT BRK 5.5 X 1 ETA 46-500-P	43	070082	1	LIGHT BLOCKER
	048505	1	CIRCT BRK 6 X 1 ETA 46-500-P	44	053247	1	LUG RNGTNG INS 22-18X10X.322
	048467	1	CIRCT BRK 7 X 1 ETA 46-500-P	45	029187	2	SPACER .19X.31X.50 ST/ZNC
	048468	1	CIRCT BRK 8 X 1 ETA 46-500-P	46	077043B	16"	FLEX CONDUIT .50 ID
	048470	1	CIRCT BRK 9 X 1 ETA 46-500-P	49	0C2323	12	SCREW PHM SWAGE 6-32X5/8 Z/YC
8	044213	1	RESIST MISC 10RX12W	51	036908	1	SCREW PPHM #6-32 X 1-1/4
9	025192	1	RECTIFIER MSC 2A 600V 1N5062	52	022155	2	WASHER LOCK #6
10	044213	1	RESIST MISC 10RX12W	53	022985	2	WASHER FLAT #6
11	055444	1	HEAT SINK 13.3L	54	022188	2	NUT HEX #6-32 STEEL
12	030468	1	WASHER STEP NYLON .20	55	036918	4	SCREW PPHM #8-32 X ½
13	049939	1	RECTIFIER MSC 12A 600V 1N1206R	56	022264	6	WASHER LOCK M4
14	083089	1	ASSY PCB "C" CONTROL 12/24V	57	033121	14	SCREW HHM 10-32 X ½
15	024469	2	SCREW TAPTITE #10-32X3/8 BP	58	022152	22	WASHER LOCK #10
17	085025	1	HARNESS 12-V. GAS	59	023897	14	WASHER FLAT #10 ZINC
18	029333	6	TIE WRAP 7" WHITE	60	022158	9	NUT HEX #10-32 STEEL
19	070097	1	DECAL TERMINAL STRIP	61	038150	4	WASHER FLAT #8 ZINC
20	026536	1	PLUG STEEL 0.5	62	022471	4	NUT HEX #8-32 STEEL
21	055867	1	SWITCH SPDT 15A SPD TGGL MOM	63	084787	1	CABLE RIBBON 16"
22	067625	1	SWITCH 3P TRIP THR 15/10A TGGL	64	070370	2	WASHER MICA .203
23	032300	1	FUSE HOLDER	65	063617	1	RELAY PNL 12VDC DPDT 10A@240VA
24	022676	1	FUSE 15A X AGC15	66	023762	1	WASHER SHAKEPROOF EXT #10 STL
25	040213	4	PCB SUPPORT SNAP-IN 1/4	67	057335	1	BLOCK TERM 20A 20 X 6 X 1100V
26	0C2428	8	SCREW TAPTITE PH #6-32X1/2 ZYC	68	046669	5	BLOCK TERM JUMPER
27	061945	1	SWITCH 6A AMP/V SELECTOR	69	098940	1	HARNESS "C" OPTION
28	071361	1	POTENTIO PNL 5K +/-10% 2.25W	70	064000	1	PANEL SIDE CONTROL
29	050123	1	KNOB PLASTIC .25 SHAFT	71	064008	1	PANEL TOP CONTROL (NOT SHOWN)
30	055349	1	INSULATOR	72	066040	1	DECAL TERMINAL STRIP
31	070030	1	COVER GENERAC SILKSCREEN	73	036904	2	SCREW PPHM #6-32 X 3/4 (NOT SHOWN)
32	070080	2	INSULATOR	74	022507	4	SCREW HHC 1/4-20 X 1/2 G5
33	070042	1	METER FREQUENCY 60HZ	75	040479	4	MOUNT VIBR 1.00X1.00X1/4-20
	070042A	1	METER FREQUENCY 50HZ	76	022097	8	WASHER LOCK M6-1/4
34	070054	1	AC AMMETER-0 TO 50	77	0441140156	1	ASSY WIRE 18AWG #0 (NOT SHOWN)
	070055	1	AC AMMETER-0 TO 100	78	033147	1	SCREW HHM #10-32 X 1 (NOT SHOWN)
	070056	1	AC AMMETER-0 TO 150	79	0C1299	1	DECAL WARNING

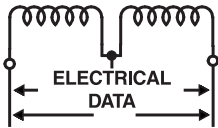

Appendix 3 – Interconnection Diagram

"C" Option Control Panel 12 Volt Gas Interconnection Diagram – Drawing No. 87625

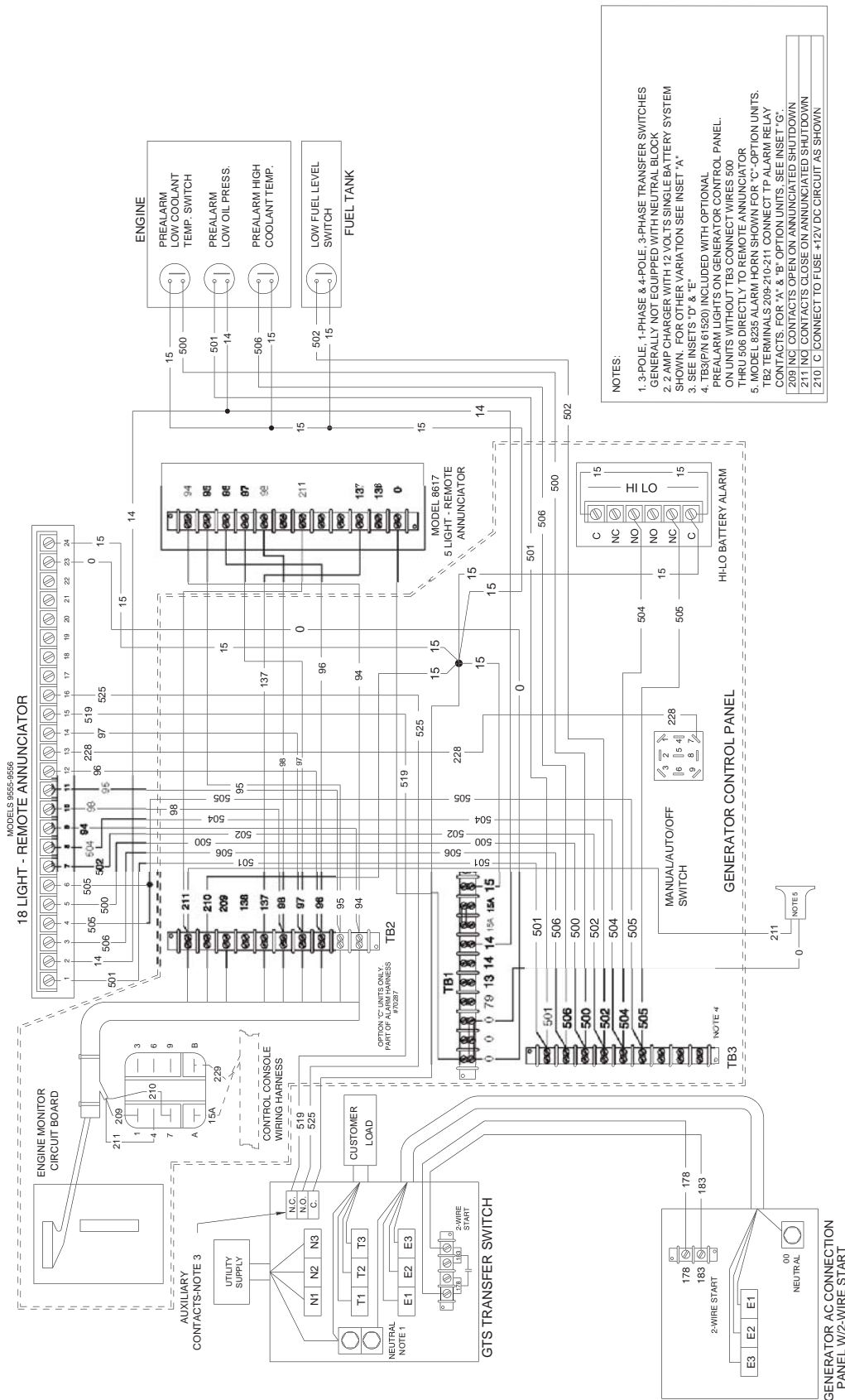

- NOTES:**
- 3-POLE, 1-PHASE & 4-POLE, 3-PHASE TRANSFER SWITCHES GENERALLY NOT EQUIPPED WITH NEUTRAL BLOCK
 - 2 AMP CHARGER WITH 12 VOLT'S SINGLE BATTERY SYSTEM SHOWN. FOR OTHER VARIATION SEE INSET 'A'
 - SEE INSETS 'D' & 'E' FOR VARIATIONS WITH OPTIONAL PRE-ALARM LIGHTS ON GENERATOR CONTROL PANEL.
 - THRU 506 DIRECTLY TO REMOTE ANNUNCIATOR
 - MODEL 8235 ALARM HORN SHOWN FOR 'C'-OPTION UNITS. TB2 TERMINALS 209-210-211 CONNECT TP ALARM RELAY CONTACTS. FOR 'A' & 'B' OPTION UNITS, SEE INSET 'G'.
 - 209 (NC) CONTACTS OPEN ON ANNUNCIATED SHUTDOWN
 - 211 (NO) CONTACTS CLOSE ON ANNUNCIATED SHUTDOWN
 - 210 (C) CONTACT TO FUSE #12V DC CIRCUIT AS SHOWN

Appendix 3 – Interconnection Diagram

"C" Option Control Panel 12 Volt Gas Interconnection Diagram – Drawing No. 87625

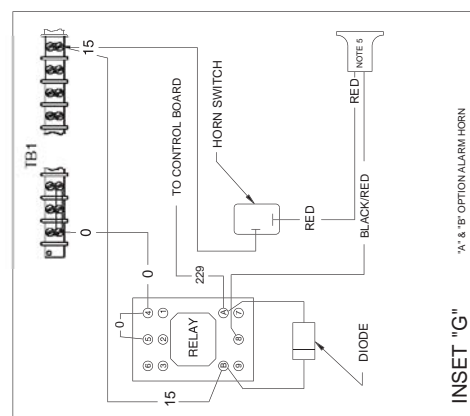
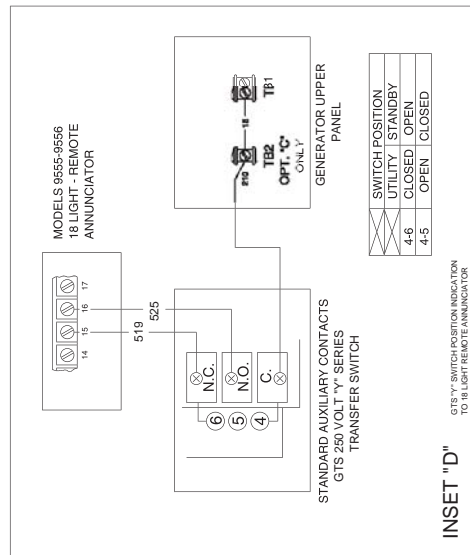
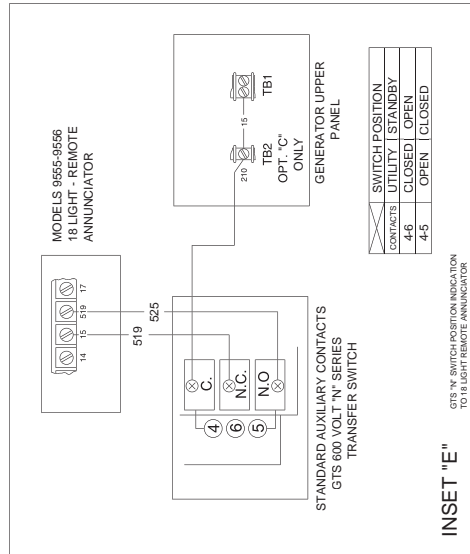
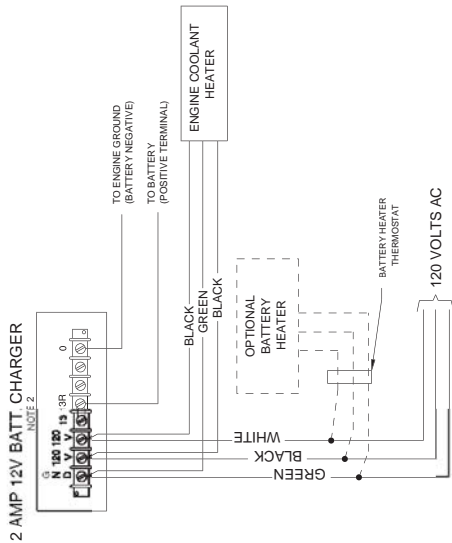
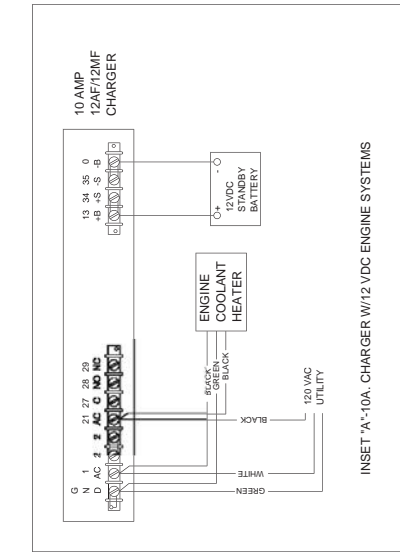
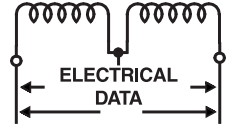

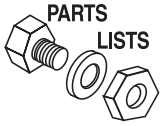

Appendix 3 – Interconnection Diagram

"C" Option Control Panel 24 Volt Diesel

Interconnection Diagram – Drawing No. 87624

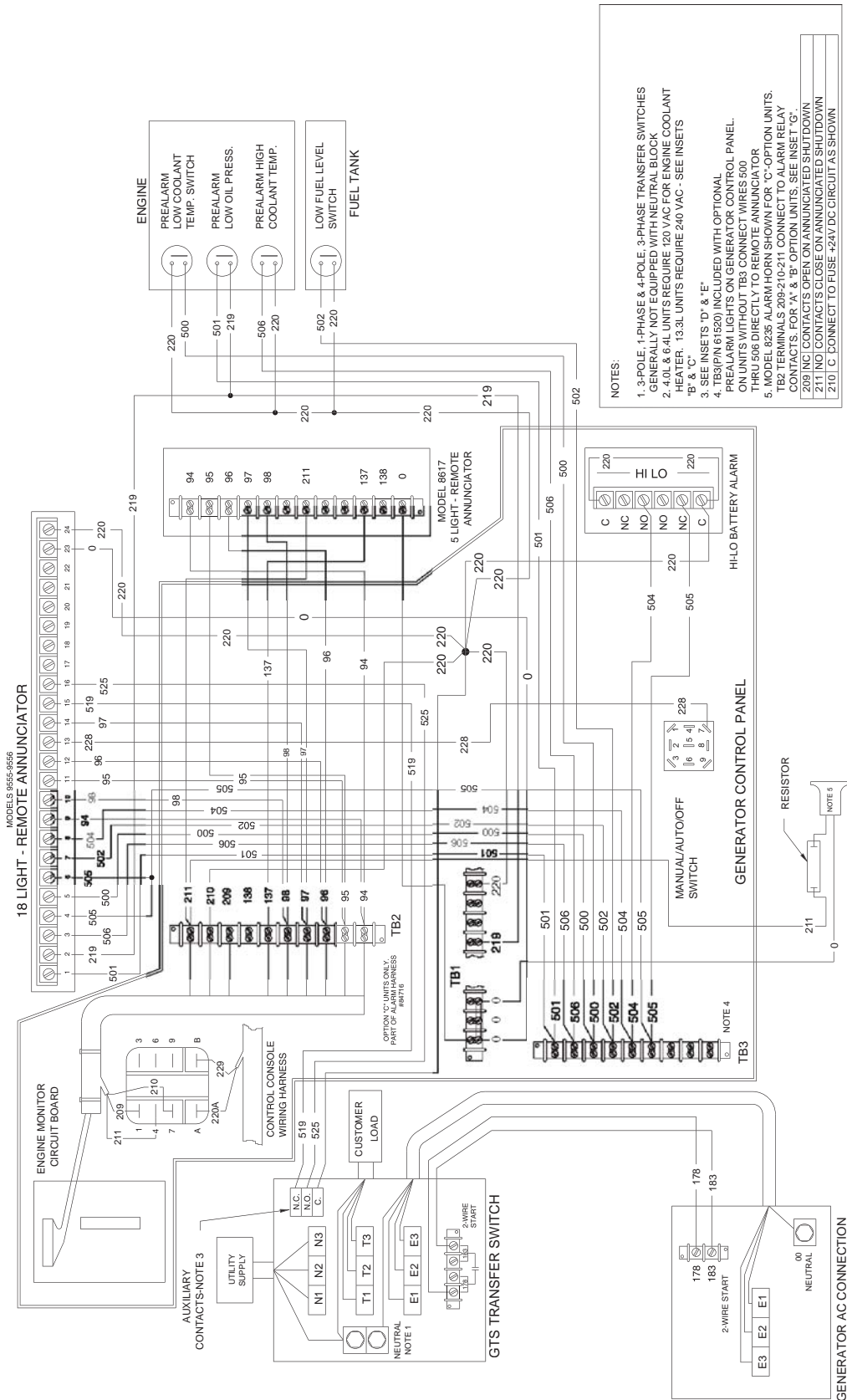

- NOTES:
- 3-POLE, 1-PHASE & 4-POLE, 3-PHASE TRANSFER SWITCHES GENERALLY NOT EQUIPPED WITH NEUTRAL BLOCK
 - 4.0L & 6.4L UNITS REQUIRE 120 VAC FOR ENGINE COOLANT HEATER. 13.3L UNITS REQUIRE 240 VAC - SEE INSERTS
 - SEE INSERTS 'D' & 'E'
 - TB5/PIN 61&60 INCLUDED WITH OPTIONAL PRE-ALARM LIGHTS ON GENERATOR CONTROL PANEL ON UNITS WITHOUT TB3 CONNECT WIRES 500 THRU 506 DIRECTLY TO REMOTE ANNUNCIATOR
 - MODEL 8235 ALARM HORN SHOWN FOR 'C'-OPTION UNITS. TB2 TERMINALS 209-210-211 CONNECT TO ALARM RELAY CONTACTS. FOR 'A' & 'B' OPTION UNITS, SEE INSET 'G'.
 - 209 (NC) CONTACTS OPEN ON ANNUNCIATED SHUTDOWN
 - 211 (NO) CONTACTS CLOSE ON ANNUNCIATED SHUTDOWN
 - 210 (C) CONNECT TO FUSE +24V DC CIRCUIT AS SHOWN

Appendix 3 – Interconnection Diagram

"C" Option Control Panel 24 Volt Diesel Interconnection Diagram – Drawing No. 87624

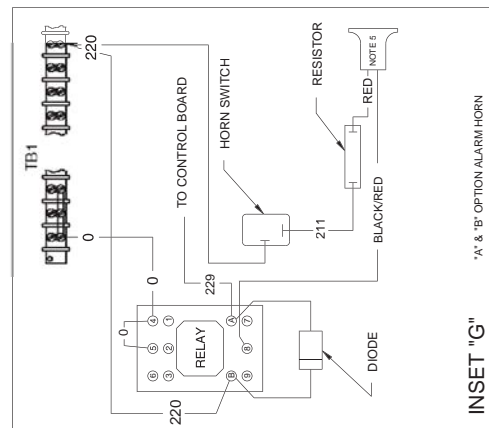
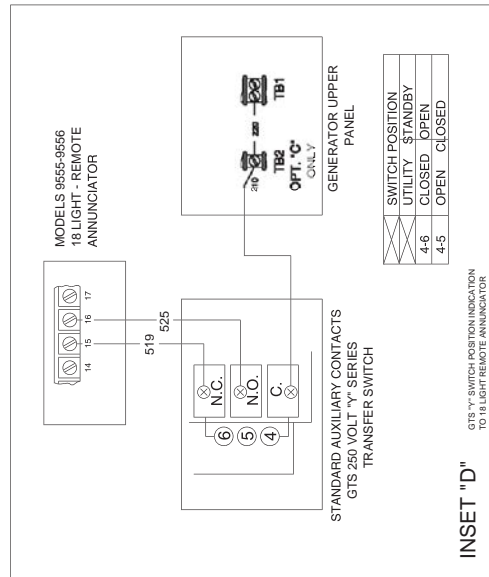
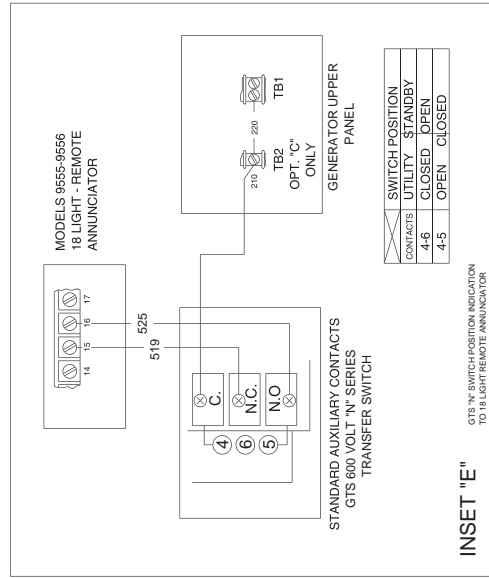
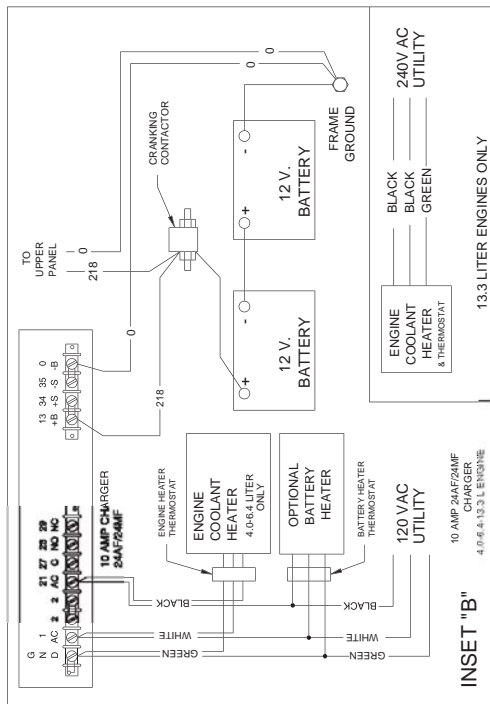
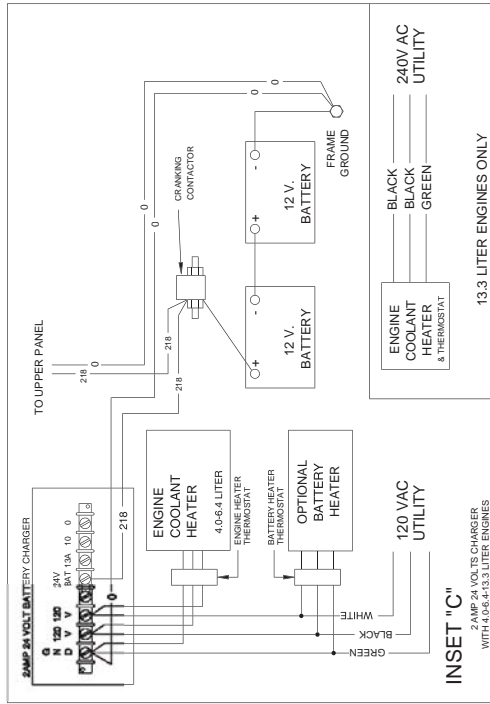
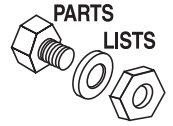

Part II

Remote Annunciator Panels

1.1 THREE LIGHT REMOTE ANNUNCIATOR

The Generac Three Light Remote Annunciator (Figure 1.1) provides a valuable reference when used with the Generac automatic transfer switch and standby generator with a C option control panel.

This equipment is designed to be mounted remotely from the standby generator set. The panel, when properly interconnected with a Generac standby generator system and transfer switch, annunciates up to three (3) standby electric system operating parameters.

- **Utility Power Supply:** This light comes ON when customer electric loads are being powered by the NORMAL (utility) power source.
- **Emergency Power Supply:** This light comes ON when customer electric loads are being powered by the EMERGENCY (standby) power source.
- **Generator Fault Light:** This light comes ON when the generator engine has shut down automatically due to a fault condition (such as low oil pressure, high coolant temperature, overcrank, overspeed, or RPM sensor loss). Fault conditions that will result in an automatic engine shutdown are discussed in the INSTRUCTIONS AND PARTS MANUAL for the applicable generator set.

Figure 1.1 — Model 8848 Annunciator Panel Lights

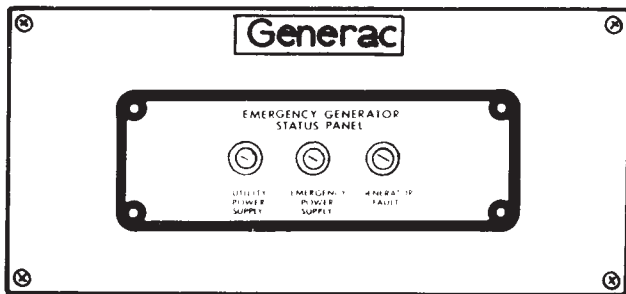

◆ 1.1.1 INSTALLATION

Mount the annunciator at any convenient location near or remote from the standby generator. Mounting dimensions are shown in Appendix ????. Holes are provided for fastening the panel to a desk, wall or other convenient object. Four 7/8" (22mm) holes are also provided for routing of required wiring into the panel. Installation must comply with all applicable codes and regulations.

Required wiring between the Model 8848 annunciator, the Generac generator meter and control (upper) panel, and transfer switch auxiliary contacts are shown in Appendix ???, Interconnection Diagram.

NOTE:

Two different types of auxiliary contacts may be encountered on Generac transfer switches.

1.2 FIVE LIGHT REMOTE ANNUNCIATOR

The Model 8617 Remote Annunciator Panel (Figure 1.2), when properly interconnected with a Generac standby generator equipped with an Option C control panel, will provide remote annunciation of the same five engine operating parameters as the generator panel. The remote panel mounts five advisory lamps. On occurrence of one or more of the panel monitored faults, the applicable lamp will illuminate and the horn will sound. Both the lamp(s) and the Alarm Horn can be turned OFF by depressing the Reset switch. All five lamps may be tested by actuating the Test switch. The following engine fault conditions will be indicated on the annunciator panel:

- Low Engine Oil Pressure
- High Engine Coolant Temperature/Low Coolant Level
- Overcrank Condition
- Overspeed Condition
- RPM Sensor Loss Condition

Figure 1.2 — Model 8617 Remote Annunciator

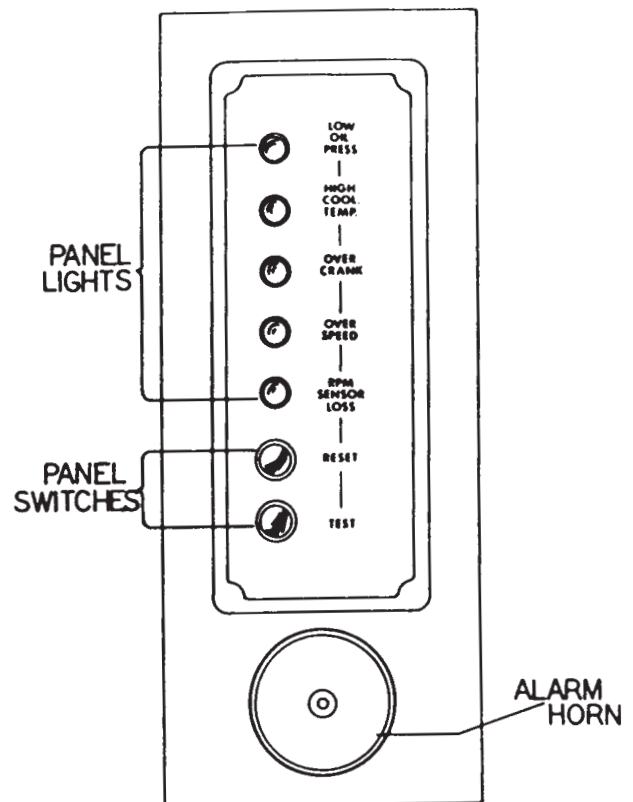

◆ 1.2.1 OPERATION

Both the remote and generator panel advisory lamps are controlled by a single DC CONTROL-LATCH-CRANK circuit board housed in the generator control console. Engine mounted, normally open (N.O.) switches and sensors provide the necessary signal to the circuit board on occurrence of a monitored engine fault. should any one (or more) of the monitored faults occur, an automatic engine shutdown, illumination of the applicable lamp(s), and sounding of the Alarm Horn will occur. circuit board action will then “latch” the fault. That is, the applicable lamp(s) will remain ON after engine shutdown. While any lamp remains lighted (latched), further attempts at generator cranking and startup are inhibited. A 12 volt DC input is required to operate the panel.

NOTE:

See applicable standby generator owner’s manual for more detailed operational description of remote and generator panel lamps.

◆ 1.2.2 CUSTOMER CONNECTIONS

Suitable, approved wiring must be purchased for interconnection of the Remote Annunciator Panel with Terminal block TB2. Connect each wire to a numbered terminal block screw and to an identically numbered terminal in the remote annunciator panel. A total of nine wires are required. Numbered terminals may be identified as follows:

- #94 — Low Oil Pressure Shutdown
- #95 — High Coolant Temperature/Low Coolant Level Shutdown
- #96 — Overcrank Shutdown
- #97 — Overspeed Shutdown
- #98 — RPM Sensor Loss Shutdown
- #137 — Test Switch Connections
- #138 — Reset Switch Connections
- #209 — Alarm Relay Normally Closed Contacts*
- #210 — Alarm Relay Common Contacts*
- #211 — Alarm Relay Normally Open Contacts*

* DO NOT EXCEED ONE (1) AMPERE OF CURRENT ACROSS ALARM RELAY CONTACTS.

◆ 1.2.3 PARTS INCLUDED WITH REMOTE PANEL

Factory shipment of any standby generator set which includes the optional Remote Annunciator Panel will include a WIRING HARNESS (Part No. 70287). The WIRING HARNESS includes the following parts:

1. Terminal Block TB2 (Part No. 55911)
2. Terminal Block Decal (Part No. 66040)
3. Alarm Relay (Part No. 63617)
4. The Wiring Harness proper

1.3 18 LIGHT REMOTE ANNUNCIATOR

The Model 9555 Remote Annunciator Panel is a self contained system, utilizing solid state circuits to annunciate up to sixteen (16) engine-driven generator operating parameters (Figure 1.3). The system meets NFPA (National Fire Protection Association) specifications for standby electric power systems.

The system will monitor any sensing device having normally-open (N.O.) contacts which provide a +DC signal to the applicable panel lamp on contacts closure. On contacts closure, both an alarm lamp and an alarm horn are activated and latched in to manual reset. The alarm horn may be silenced without disturbing the visual indication and with any subsequent alarm re-activating the horn. The system includes a test circuit.

NOTE:

The one exception to the normally-open (N.O.) contacts rule is the **LOW BATTERY VOLTAGE lamp**. This lamp must be connected to normally-closed (N.C.) contacts on the battery monitor circuit board, located in the generator control panel.

Figure 1.3 — Model 9555 Remote Annunciator Panel

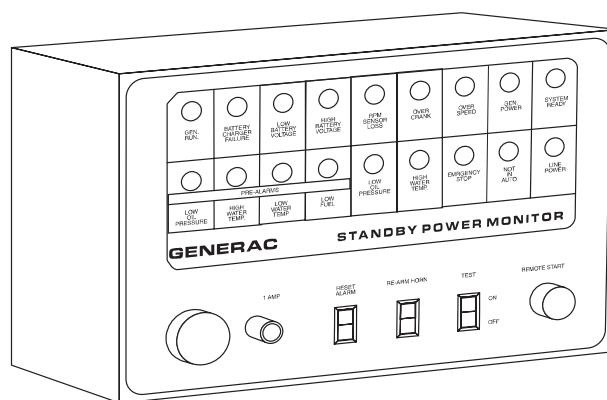

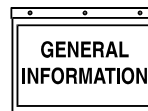

◆ 1.3.1 GENERATOR STOP SIGNALS

All signals occur when generator shutdown occurs as a result of the failure indicated by the illuminated lamp(s).

1. **High Water Temperature/Low Water Level:** This lamp comes ON and the horn sounds when the generator's high temperature alarm is active.
2. **Low Oil Pressure:** This lamp illuminates and the alarm horn sounds when the generator's low oil pressure alarm is active.
3. **Overspeed:** This lamp turns ON and the alarm horn sounds when the generator's overspeed alarm is active.
4. **Overcrank:** This lamp turns on and the alarm horn sounds when the generator's overcrank alarm is active.
5. **Sensor Loss:** This lamp illuminates and the alarm horn sounds when the generator's rpm sensor loss alarm is active.

◆ 1.3.2 LATCHABLE SIGNALS

The following signals can be individually selected by means of miniature rocker switch on the Remote Panel's monitor circuit board. The available switch positions are "Latch On" and "Latch Off". "Latch Off" indicates the lamp will turn ON only when the signal is present. "Latch On" indicates the lamp will be ON until the monitor "Reset" switch is pressed. The alarm horn sounds when "Latch" is selected. The horn will stay ON until either the "Rearm Horn" or the "Reset" switch is pressed.

1. **Low Battery Voltage:** This lamp illuminates when the generator's battery voltage drops low, indicating a discharge condition.
2. **High Battery Voltage:** This lamp will turn ON when generator battery voltage is high, indicating an overcharge condition.
3. **Battery Charger Failure:** This lamp will illuminate on failure of the generator's battery charge system.
4. **Low Fuel:** This lamp illuminates when an occurrence of a low fuel level in the generator's fuel tank.
5. **Pre-alarm/High Temp.:** This lamp will illuminate to warn of an approaching or imminent high coolant temperature shutdown.
6. **Pre-alarm/Low Temp.:** This lamp will illuminate when the coolant temperature has decreased, indicating an engine coolant heater failure.
7. **Pre-alarm/Low Oil Pressure:** This lamp will illuminate in advance of a low oil pressure shutdown. It indicates engine oil pressure has decreased to near the point of automatic shutdown.

8. **Generator Run:** This lamp illuminates to advise that the generator has started and/or is running. Lamp ON indicates the generator "run" circuit is active (Wire #14 on units with 12 volts DC engine control system, Wire #219 on units with 24 volts DC engine control system).

◆ 1.3.3 OTHER LAMPS

1. **System Ready:** This lamp will be ON to indicate the generator set is able to run. If the lamp is OUT, a "stop" signal is present.
2. **Not In Auto:** This lamp will illuminate to indicate the generator's Auto-Off-Manual switch is NOT set to "Auto" (that is, the switch is set to either "Manual" or "Off" and automatic operation is not possible).
3. **Horn Switch Off:** This lamp will turn ON to indicate the horn switch on the annunciator panel is turned OFF. With the horn switch set to OFF, lamps will not be affected. However, the alarm horn will not sound.
4. **Line Power:** This lamp will be ON when the automatic transfer switch main contacts are in their "Utility" position (and connected to the "Utility" power supply).
5. **Generator Power:** This lamp will turn ON when the transfer switch main contacts are in their "Standby" position, i.e., load is connected to the generator power supply.

◆ 1.3.4 PANEL WIRING INTERCONNECTIONS

All INPUT signal connections are made at a 24 screw terminal block, located on the Remote Panel's MONITOR CIRCUIT BOARD. Use purchased No. 14 AWG wiring for all interconnections. Maximum recommended distance between the Remote Panel and the standby generator should not exceed 1000 feet (305 meters). See page 36 for installer's wiring interconnections.

1.4 TROUBLESHOOTING

Troubleshooting the 18 lamp annunciator is limited to checking wire connections at the generator panel, transfer switch and annunciator, and checking for proper DC inputs to annunciator terminal strip. If all connections and input DC voltage signals are good but a problem still exists with the annunciator operation, replace annunciator circuit board.

1. **Automatic Generator Stop Signals:** The horn and lamp are always latched if one of these signals occurs. Generator stop lamps and horn can be reset by either the test/reset switch at the annunciator or reset of fault lamps at the generator.
2. **Test/Reset:** Pressing the test/reset switch energizes all lamps except the "horn switch off" lamp and the horn. Release of the switch resets the lamps and horn. The test/reset switch has no effect on fault indicators at the genset.

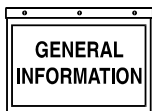

Section 1 – General Information

Remote Annunciator Panels

3. **Latch Select:** The lamps and horn can be selected to be latched by on-board switch. Unlatched signals activate the lamp only; the lamp is de-energized if the fault signal is cleared. Latching provides an audible signal plus keeps the lamp energized as an indicator even if the pre-alarm fault has been cleared.
4. **Rearm:** The rearm clears the horn but not the lamps. The lamps are held active by either latch or fault signal. After rearm, horn is enabled to sound if another fault occurs.
5. **System Ready Lamp:** This lamp indicates the genset is operational. The lamp is energized whenever power is applied to the annunciator circuit and no generator stop signals are present.
6. **Line-Power/Gen Power Lamps:** This indicates the position of the transfer switch. When load is transferred to the genset, the “Generator Power” lamp is lit and the horn sounds.
7. **Horn Switch Off Lamp:** This lamp indicates that power to the horn has been disconnected by a horn disable switch.
8. **Annunciator Delays:** Signals will be annunciated if they exist for the following minimum times:
 - Not in Auto, Horn Off, 100 seconds.
 - Pre-alarm Low Oil Pressure, 10 seconds.
 - All others, 1 second.

1.5 ANNUNCIATED SIGNALS

Signal	Source	Lamp	Response	Latched	Rearm
High Temp.	Control Board*	Red	Lamp & Horn	Yes	Yes
Low Oil	Control Board*	Red	Lamp & Horn	Yes	Yes
Overspeed	Control board*	Red	Lamp & Horn	Yes	Yes
Overcrank	Control Board*	Red	Lamp & Horn	Yes	Yes
Sensor Loss	Control Board*	Red	Lamp & Horn	Yes	Yes
System Ready	Annunciator	Green	Lamp	No	N/A
Line Power	Transfer Switch	Green	Lamp	No	N/A
Generator Power	Transfer Switch	Yellow	Lamp & Horn	No	Yes
High Battery	Battery Monitor	Yellow	Lamp & Horn	Select	Yes
Low Battery	Battery Monitor	Yellow	Lamp & HOrn	Select	Yes
Not In Auto	Control Board	Red	Lamp & Horn	No	No
Horn Switch Off	Annunciator	Red	Lamp	No	N/A

1.6 PRE-ALARMS

Signal	Source	Lamp	Response	Latched	Rearm
Low Fuel	Float Switch	Yellow	Lamp & Horn	Select	Yes
High Temperature	Temperature Switch	Yellow	Lamp & Horn	Select	Yes
Low Temperature	Temperature Switch	Yellow	Lamp & Horn	Select	Yes
Low Oil	Pressure Switch	Yellow	Lamp & Horn	Select	Yes
Generator Run	Control Board	Yellow	Lamp & Horn	Select	Yes
Battery Charge Fail	Battery Monitor	Yellow	Lamp & Horn	Select	Yes

Appendix 4 – Electrical Data
 Three Light Remote Annunciator
 Mounting Dimensions

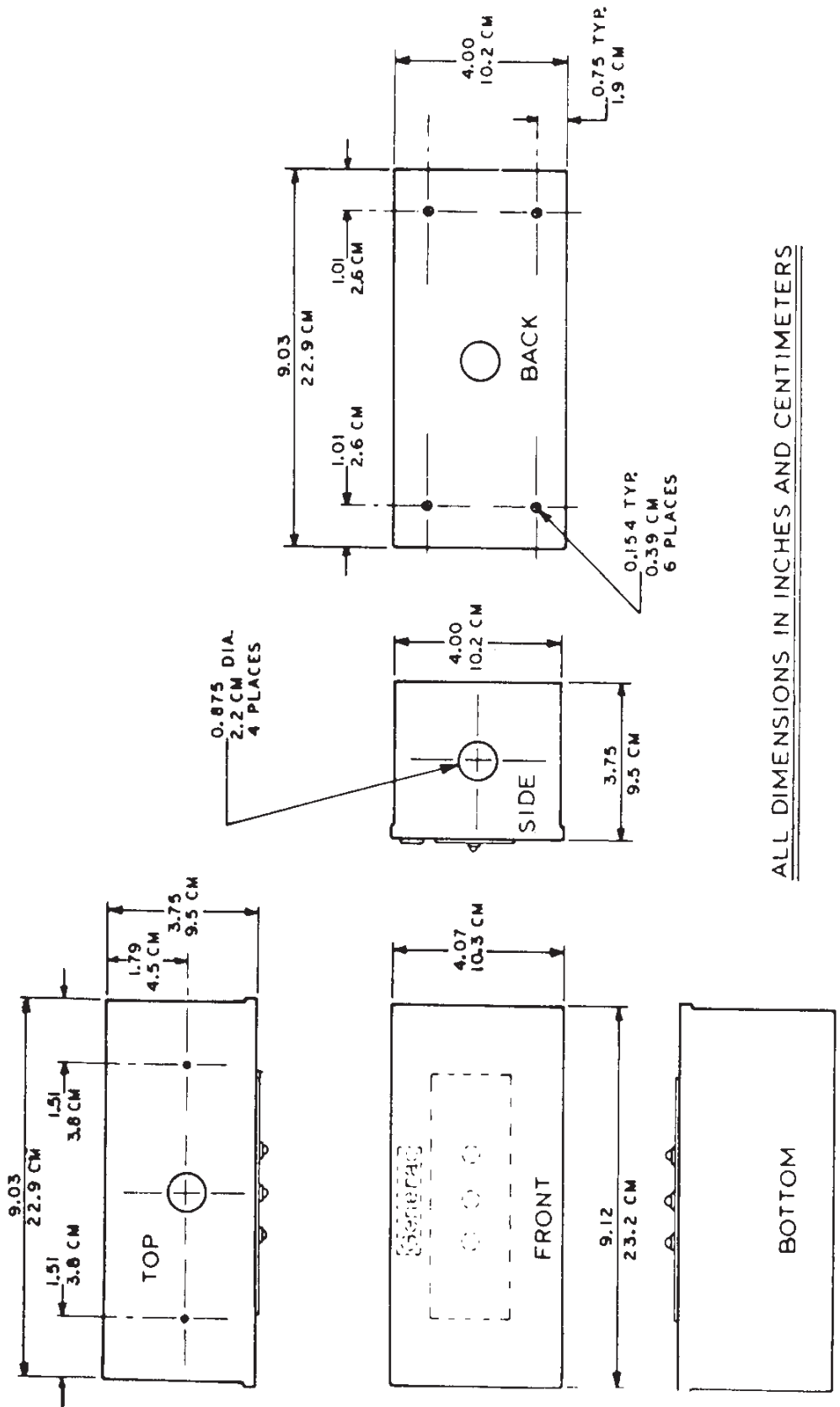
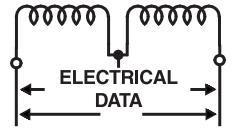

ALL DIMENSIONS IN INCHES AND CENTIMETERS

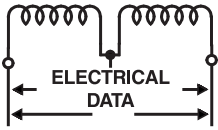

Appendix 4 – Electrical Data
Five Light Remote Annunciator
Mounting Dimensions

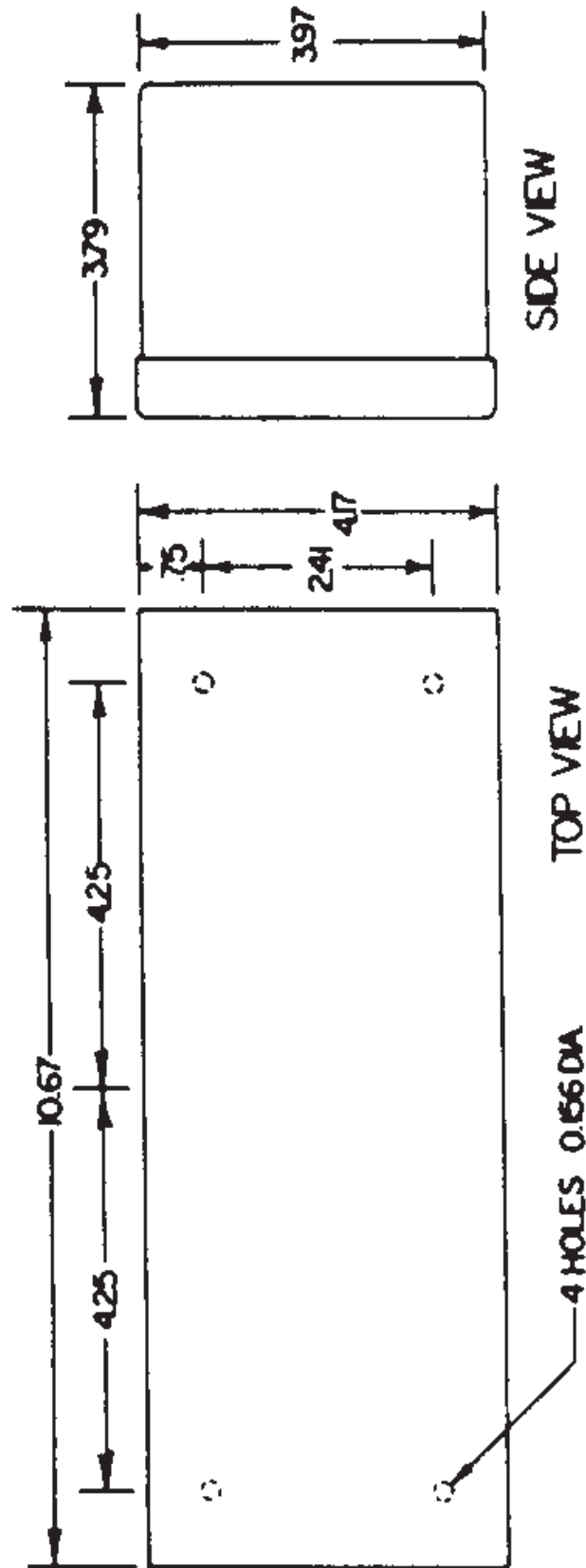

Appendix 4 – Electrical Data

18 Light Remote Annunciator
Mounting Dimensions

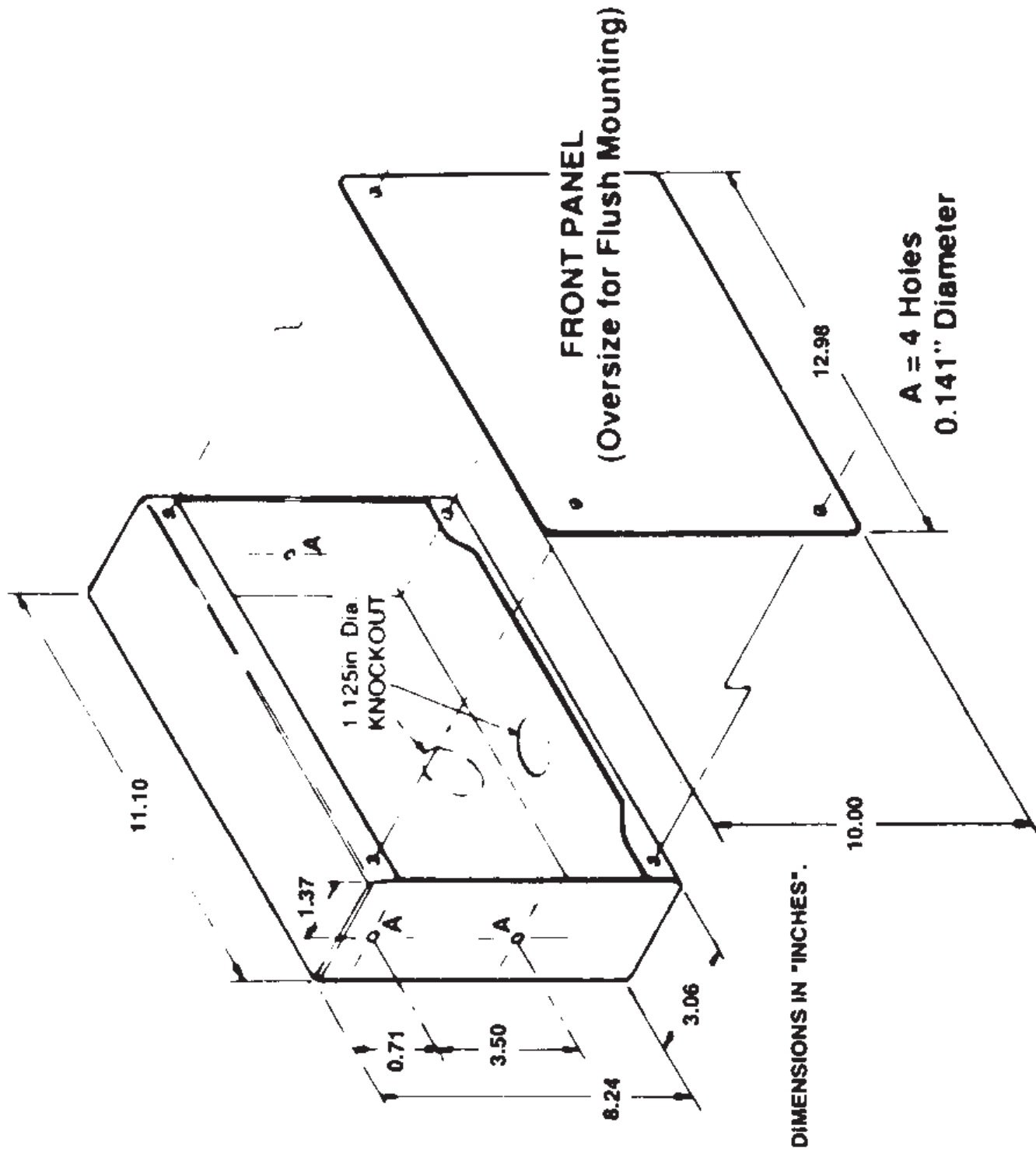
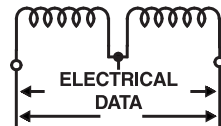

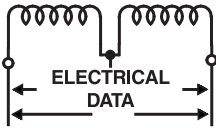

Appendix 4 – Electrical Data

Three Light Remote Annunciator Interconnection Diagram

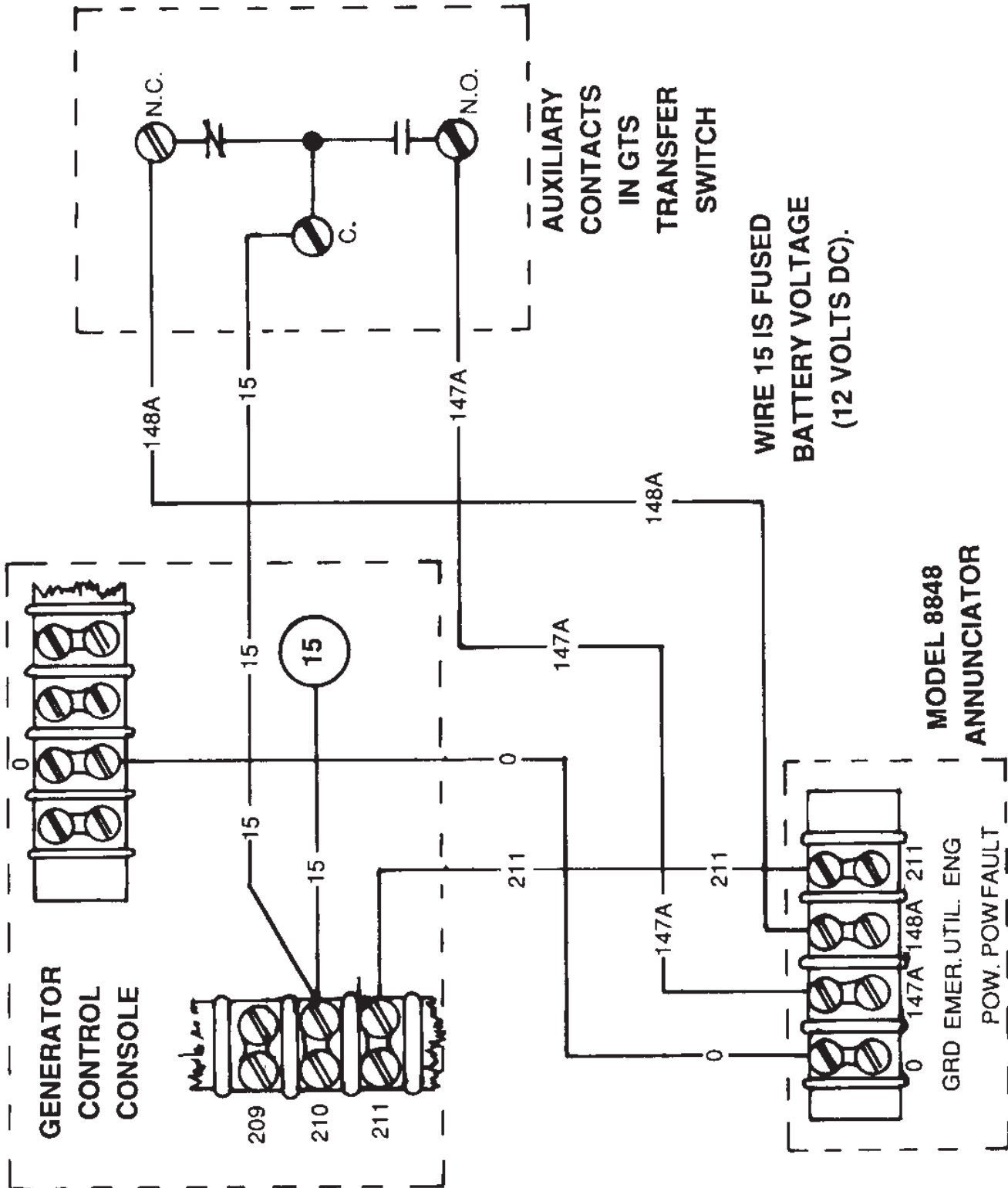

Appendix 4 – Electrical Data
 Five Light Remote Annunciator
 Interconnection Diagram

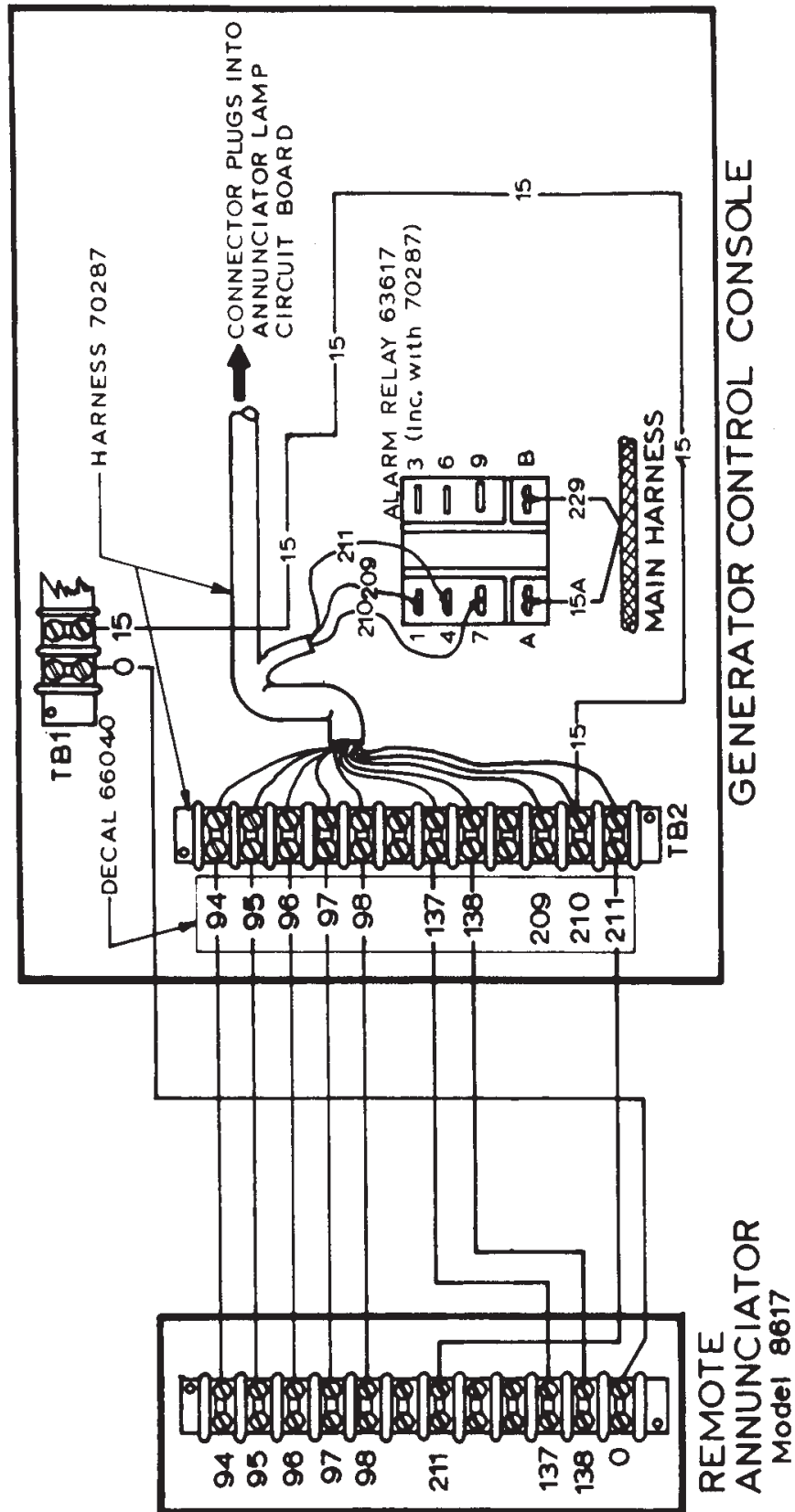
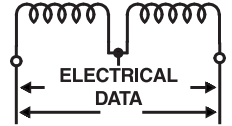

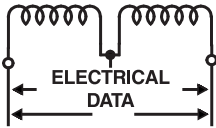

Appendix 4 – Electrical Data

Five Light Remote Annunciator
Electrical Schematic – Drawing No. 066561

- Legend**
- L1 = Low Oil Pressure Lamp
 - L2 = High Coolant Temperature Lamp
 - L3 = Overcrank Lamp
 - L4 = Overspeed Lamp
 - L5 = RPM Sensor Loss Lamp
 - SW1 = Reset Switch
 - SW2 = Test Switch
 - H1 = Alarm Horn

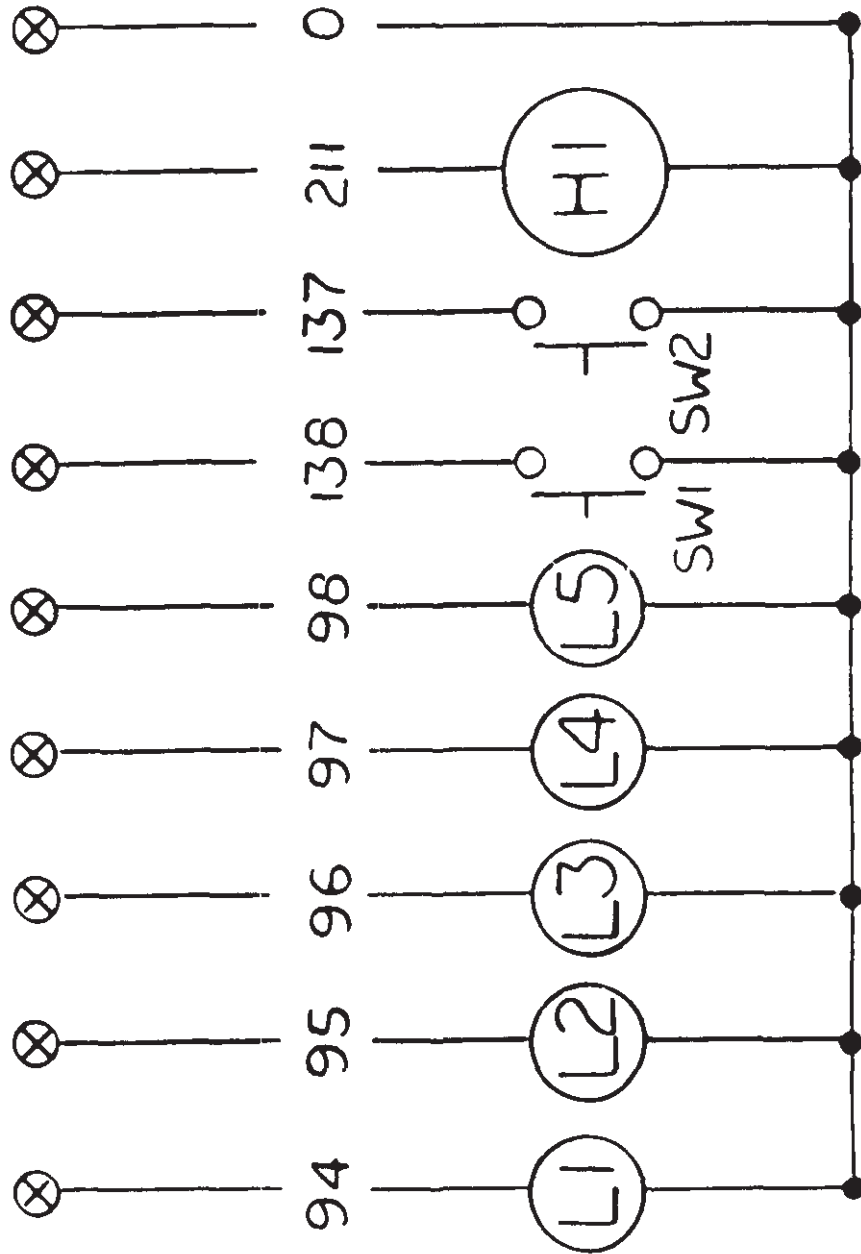

Appendix 4 – Electrical Data
Three Light Remote Annunciator
Electrical Schematic – Drawing No. 067787

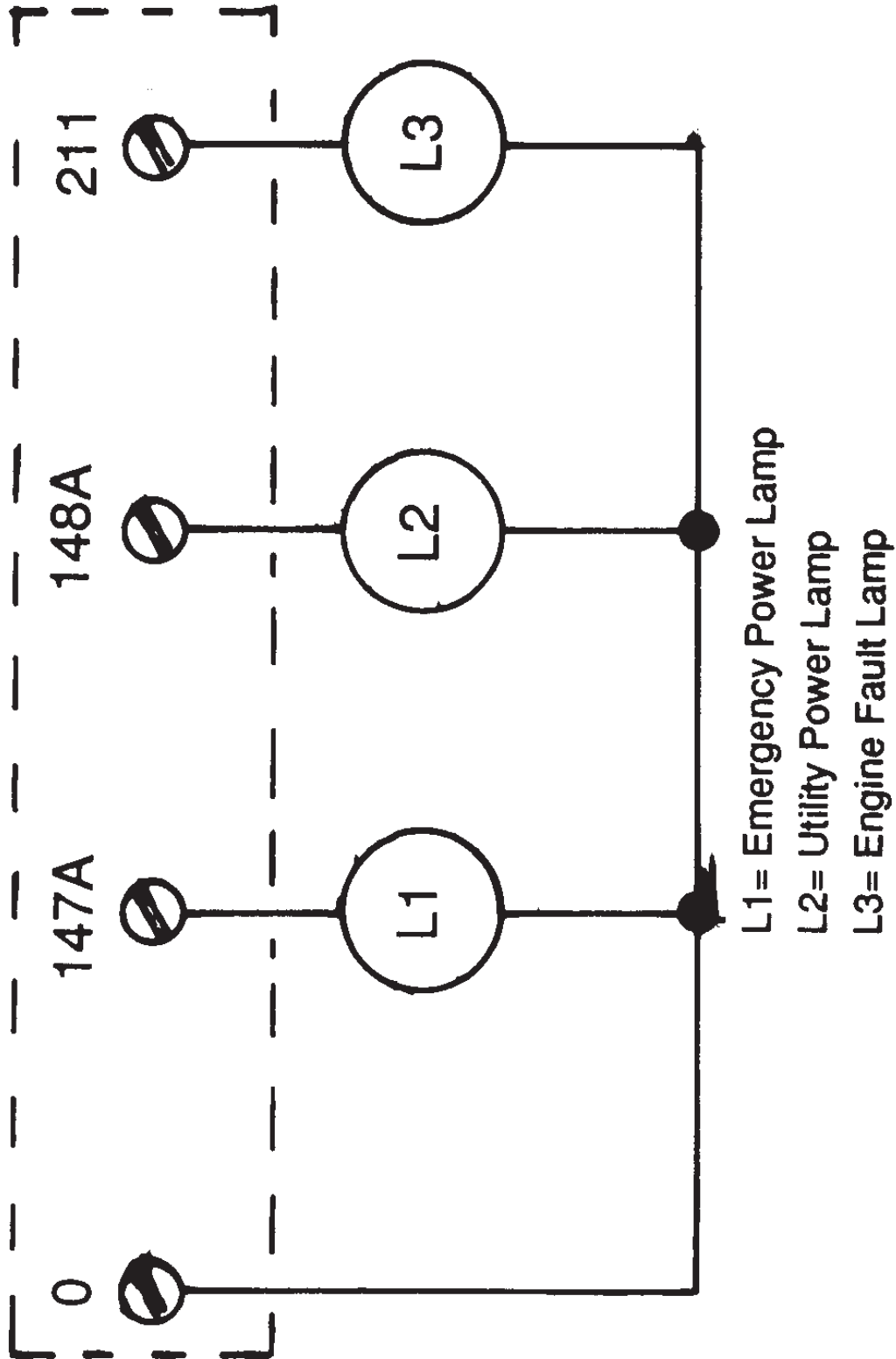
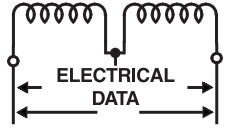

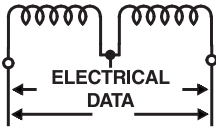

Appendix 4 – Electrical Data

**18 Light Remote Annunciator
Wiring Diagram – Drawing No. 086833-C**

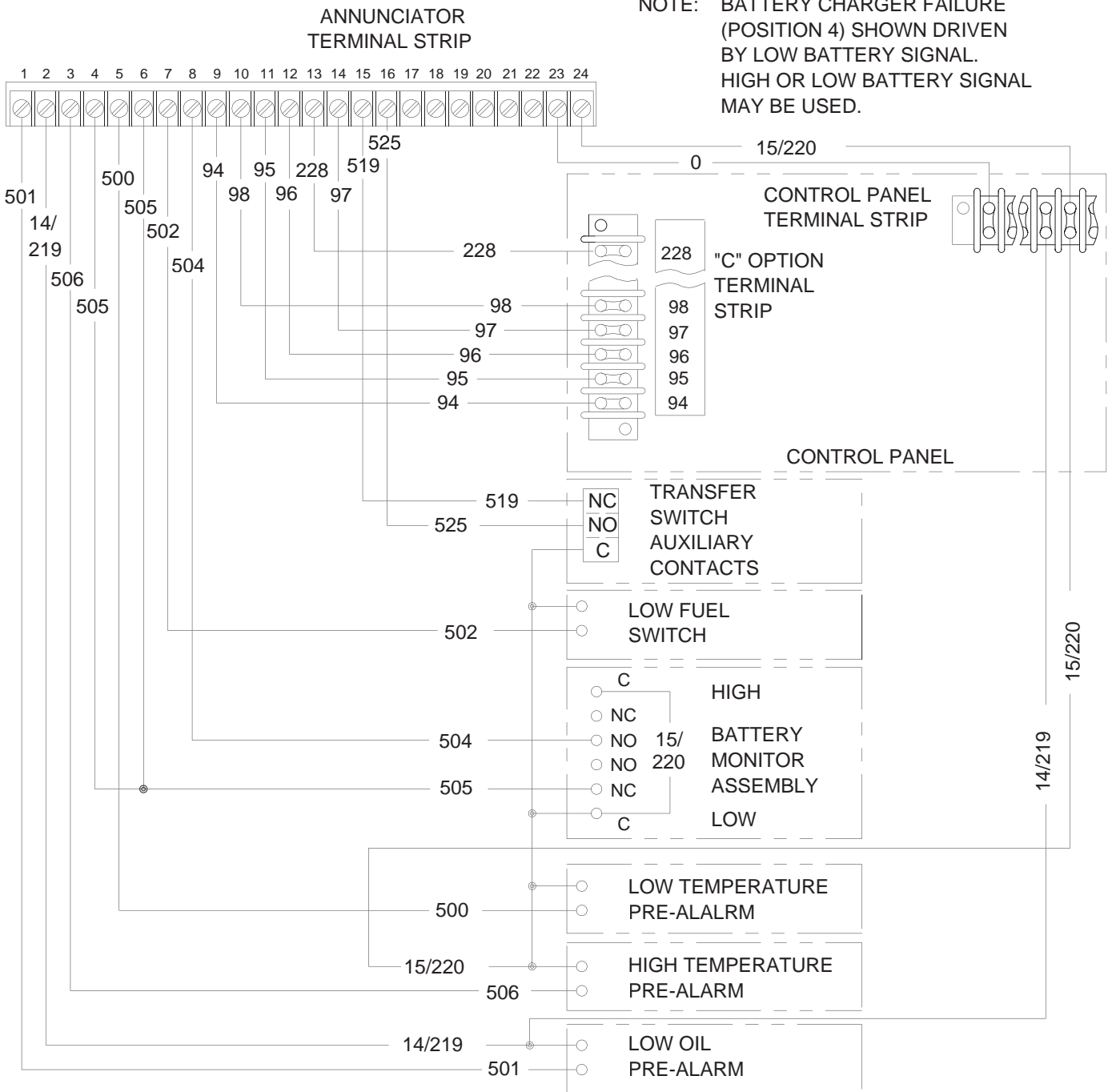

Appendix 5 – Exploded Views and Parts Lists

Three Light Remote Annunciator
Drawing No. 067786

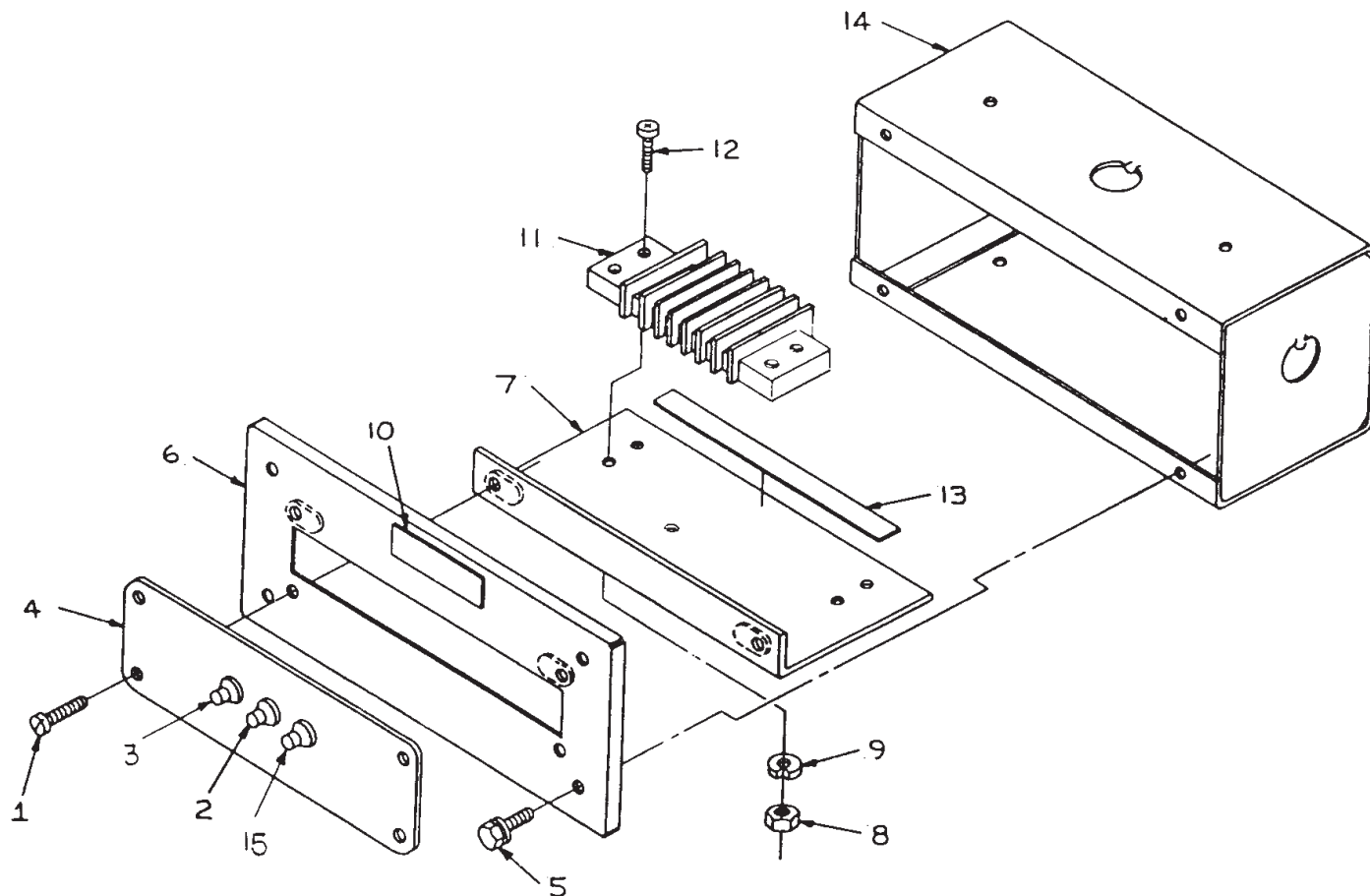
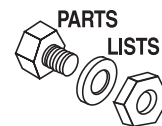

ITEM	PART NO.	QTY.	DESCRIPTION
1	022442	4	NO. 6-32 X 3/8" ROUND HEAD MACHINE SCREW
2	064009-A	1	LAMP - YELLOW
3	064009-B	1	LAMP - GREEN
4	067783	1	PANEL (SILKSCREENED)
5	056892	4	NO. 10-24 X 3/8" CRIMPTITE SCREW
6	059143	1	FRONT PANEL
7	059144	1	PANEL SUPPORT BRACKET
8	022471	2	NO. 8-32 HEX NUT
9	022264	2	NO. 8 LOCK WASHER
10	059149	1	GENERAC DECAL
11	046357	1	TERMINAL BLOCK
12	036919	2	NO. 8-32 X 5/8" PAN HEAD MACHINE SCREW
13	067784	1	TERMINAL BLOCK DECAL
14	059142	1	ENCLOSURE
15	064009	1	LAMP - RED

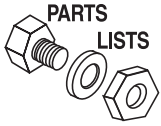

Appendix 5 – Exploded Views and Parts Lists

Five Light Remote Annunciator Mounting Locations in Generator Control Console for Optional Terminal Boards and Alarm Relay

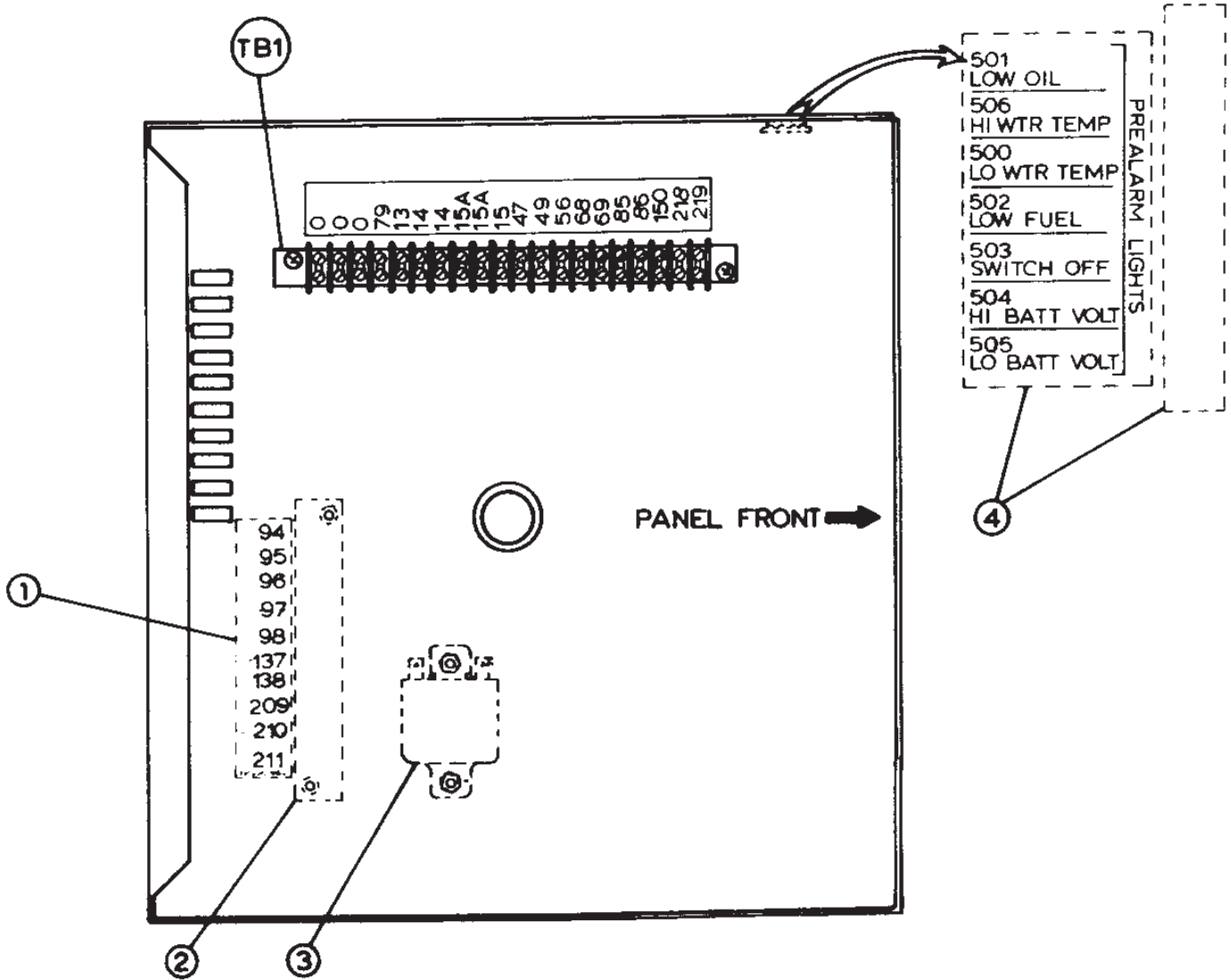

ITEM	PART NO.	QTY.	DESCRIPTION
1	066040	1	DECAL, TERMINAL BOARD
2	055911	1	BOARD, TERMINAL
3	063617	1	RELAY, ALARM
4		1	BOARD, TERMINAL & DECAL (OPTIONAL PRE-ALARM)

Appendix 5 – Exploded Views and Parts Lists

Five Light Remote Annunciator Panel Assembly - Drawing No. 066559-B

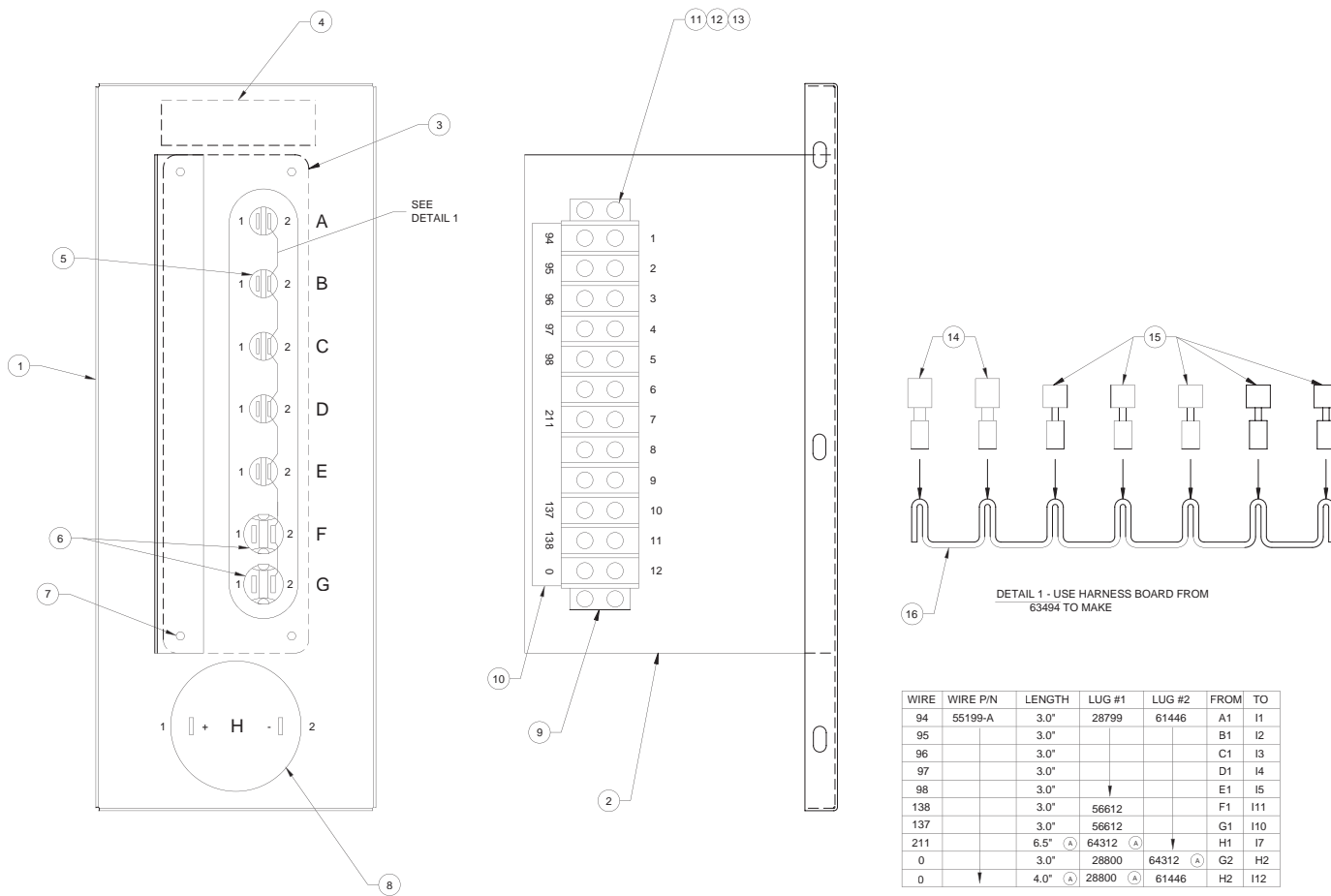
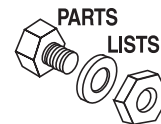

WIRE	WIRE P/N	LENGTH	LUG #1	LUG #2	FROM	TO
94	55199-A	3.0"	28799	61446	A1	I1
95		3.0"			B1	I2
96		3.0"			C1	I3
97		3.0"			D1	I4
98		3.0"			E1	I5
138		3.0"	56612		F1	I11
137		3.0"	56612		G1	I10
211		6.5" (A)	64312 (A)		H1	I7
0		3.0"	28800	64312 (A)	G2	H2
0		4.0" (A)	28800 (A)	61446	H2	I12

ITEM	PART NO.	QTY.	DESCRIPTION
1	066556	1	FRONT PANEL
2	066558	1	SUPPORT - TERMINAL STRIP
3	064012	1	MONITER PANEL - SILKSCREENED
4	059149	1	DECAL - GENERAC
5	064009	5	INDICATOR LIGHT (RED)
6	055920	2	PUSH BUTTON SWITCH
7	049441	4	#6-32 X 3/8" TAPTITE
8	061286	1	SOUND - ALERT
9	055911	1	TERMINAL STRIP
10	059150-A	1	DECAL
11	036919	2	#8-32 X 5/8" PPHMS
12	022264	2	#8 LOCK WASHER
13	022471	2	#8-32 HEX NUT
14	030957	2	RECEPTACLE LUG 1/4"
15	028799	5	RECEPTACLE LUG 1/4"
16	032012	14.5"	#20 BARE COPPER WIRE



Appendix 5 – Exploded Views and Parts Lists

**Five Light Remote Annunciator
Harness (098940) - Drawing No. 070287-C**

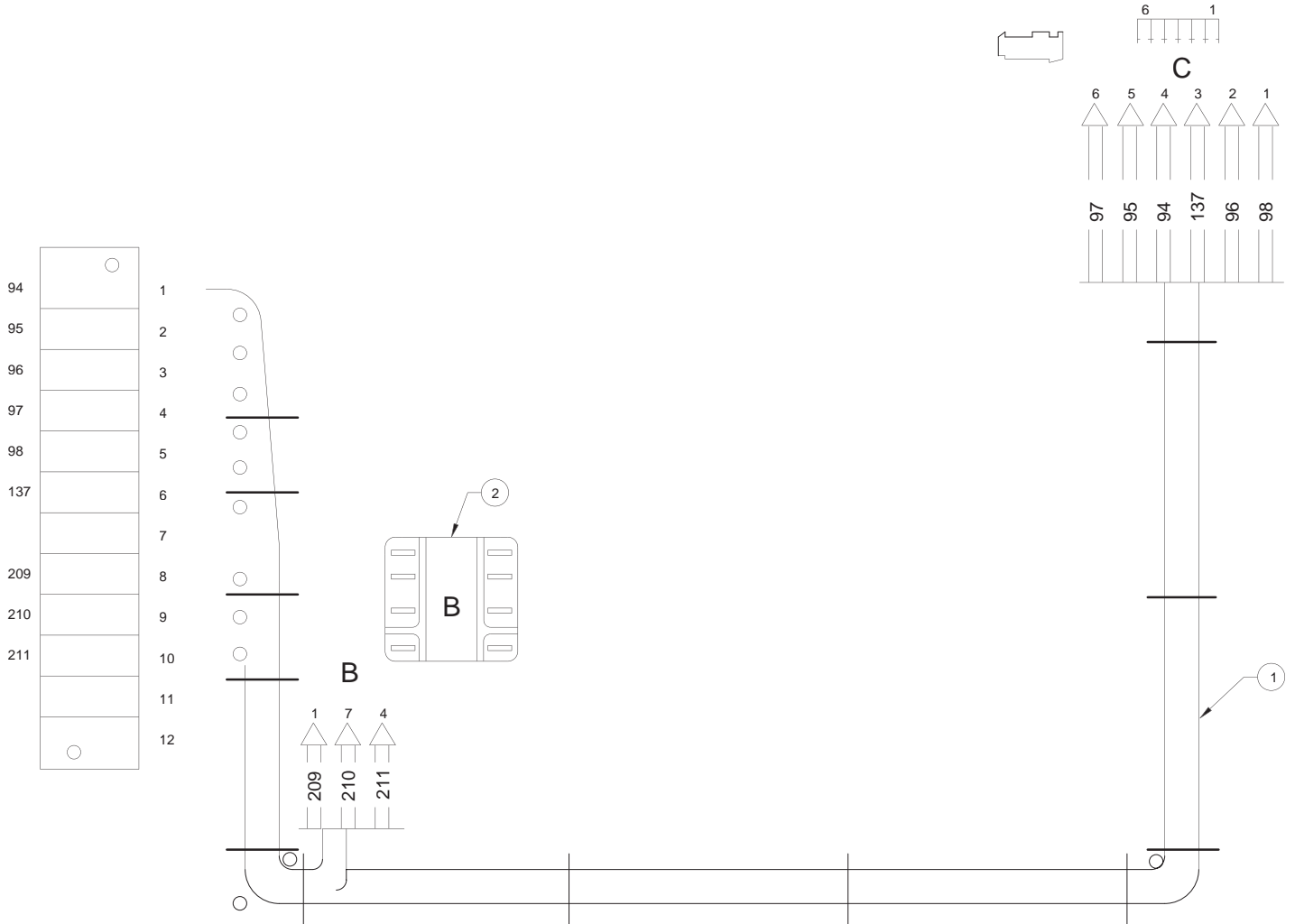

ITEM	PART NO.	QTY.	DESCRIPTION
1	098940	1	HARNESS
2	063617	1	RELAY

Appendix 5 – Exploded Views and Parts Lists

Five Light Remote Annunciator Harness (C Option Control Panel) - Drawing No. 098940-C

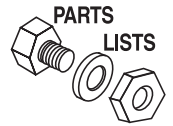

WIRE #	LGTH.	WIRE DESC.	LUG #1	LUG #2	FROM	TO
94	26.5	UL 1007/1569 TEW	ETC# AA-2190-06X-T	AMP# 35 0980-3	A1	C4
95	26.06	#18 AWG 300V	INSULATED SNAPSPADE	OR EQUIVALENT	A2	C5
96	25.62	16 STRANDS/30 AWG	#6 SCREW 18-22 AWG		A3	C2
97	25.19	DK BLUE COLOR	OR EQUIVALENT		A4	C6
98	24.75				A5	C1
137	24.31				A6	C3
209	7.00			ETC# BB-8138-T	A8	B
210	6.56			INSULATED FASTON	A9	B
211	6.12			.187 X .020" #18-22 AWG	A10	B
228	19.5			0.25" PIGGYBACK FASTON GENERAC P/N - 028800	A12	D

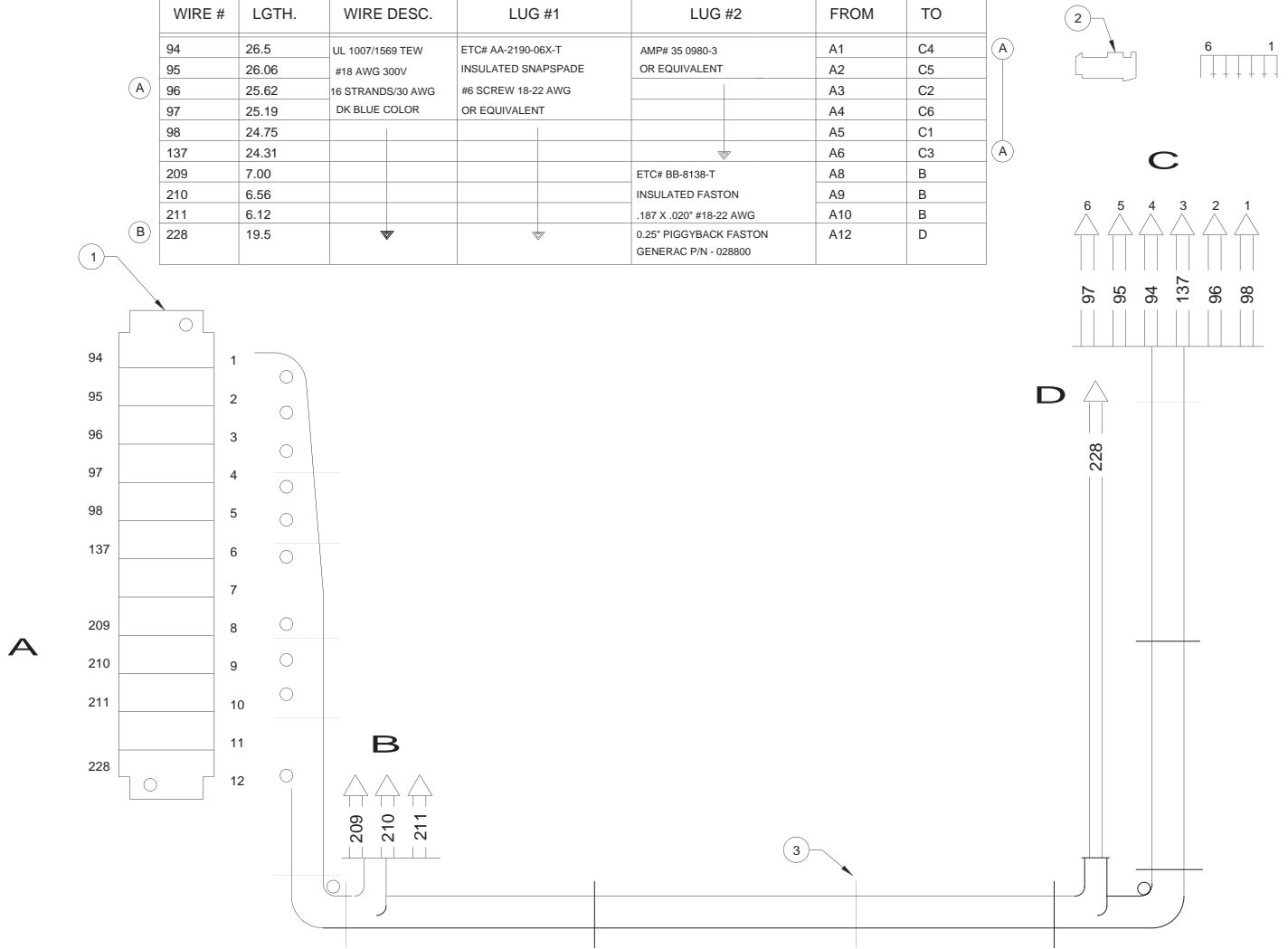

ITEM	PART NO.	QTY.	DESCRIPTION
1	055911	1	TERMINAL BLOCK VERNITRON #09012
2	071271	1	CONNECTOR 6-CKT AMP P/N 640250
3	028739	12	TIE WRAP 4"

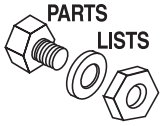

Appendix 5 – Exploded Views and Parts Lists

18 Light Remote Annunciator Drawing No. 086585-C

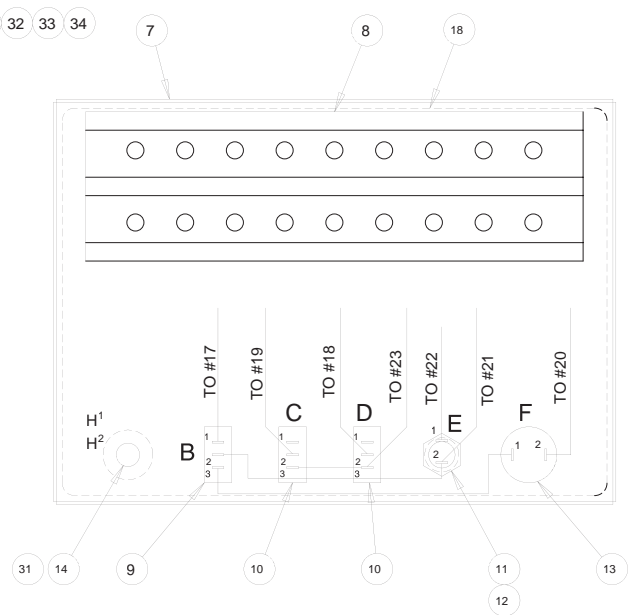
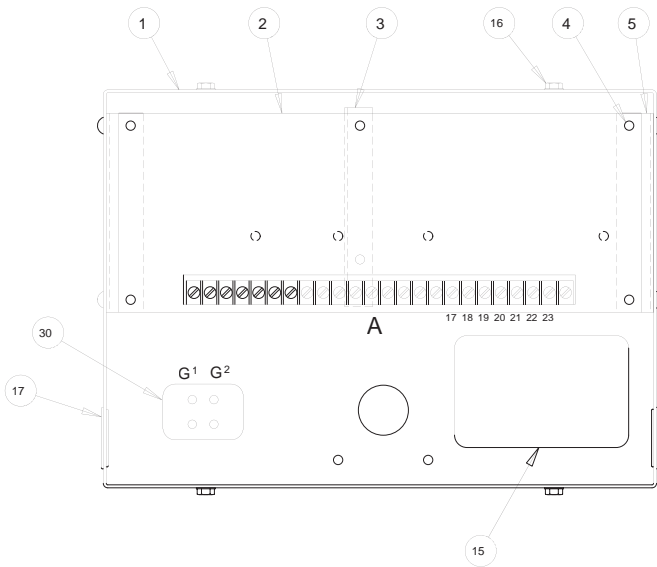
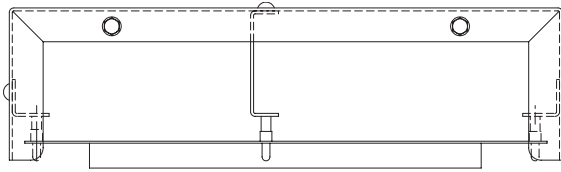

ITEM	PART NO.	QTY.	DESCRIPTION
1	086582	1	PANEL, ANNUNCIATOR REAR
2	084968	1	PC BOARD - MONITOR
3	086579	1	SUPPORT, PC BOARD
4	040213	6	PCB STAND OFF
5	086580	2	SUPPORT, PC BOARD
6	036901	6	#6-32 X 3/8" PHCS
7	086581	1	PANEL, ANNUNCIATOR FRONT
8	061282-A	1	DECAL, CLEAR LEXAN
9	061283	1	SWITCH, ON/OFF
10	061284	2	SWITCH, TEST/RESET
11	032300	1	HOLDER, FUSE
12	044299	1	FUSE, 1 AMP
13	061286	1	SOUNALERT
14	077704	1	PLUG
15	086584	1	DECAL, ATTENTION

ITEM	PART NO.	QTY.	DESCRIPTION
16	056892	4	CRIMPTITE
17	025034	2	PLUG BUTTON
18	086583	2	DECAL, ANNUNCIATOR
29*	028739	2	TIE WRAP
30†¥	048766	1	TERM BLOCK
31†¥	055869	1	SWITCH - TOGGLE, SPST
32	022985	6	#6 FLAT WASHER
33	022155	6	#6 LOCK WASHER
34	022188	6	#6-32 HEX NUT

* NOT SHOWN

SERIES
 † 86585B — 86583 DECAL
 ¥ 86585M — 86583M DECAL

GENERAC® POWER SYSTEMS, INC.

P.O. BOX 8
WAUKESHA, WI 53187

Part No. OC4205

Revision B (09/27/02)

Printed in U.S.A.