

GENERAC[®]

POWER SYSTEMS, INC.

Owner's Manual

GTS "W" Type

**Automatic
Transfer Switch**

200 Amp, 250 Volts



⚠ Read the following information carefully before attempting to install, operate or service this equipment. Also read the instructions and information on tags, decals, and labels that may be affixed to the transfer switch. Replace any decal or label that is no longer legible.

⚠ **DANGER!** Connection of a generator to an electrical system normally supplied by an electric utility shall be by means of suitable transfer equipment so as to isolate the electric system from utility distribution system when the generator is operating (Article 701 Legally Required Standby Systems or Article 702 Optional Standby Systems, as applicable). Failure to isolate electric system by these means may result in damage to generator and may result in injury or death to utility workers due to backfeed of electrical energy.

Generac cannot possibly anticipate every possible circumstance that might involve a hazard. The warnings in this manual, and on tags and decals affixed to the unit are, therefore, not all-inclusive. If you use a procedure, work method or operating technique Generac does not specifically recommend, you must satisfy yourself that it is safe for you and others. You also must make sure the procedure, work method or operating technique that you choose does not render the transfer switch unsafe.

Throughout this publication, and on tags and decals affixed to the generator, DANGER, WARNING, CAUTION and NOTE blocks are used to alert you to special instruction about a particular operation that may be hazardous if performed incorrectly or carelessly. Observe them carefully. Their definitions are as follows:

— **⚠ DANGER ⚠** —

After this heading, you can read instructions that, if not strictly complied with, will result in personal injury or property damage.

— **⚠ WARNING ⚠** —

After this heading, you can read instructions that, if not strictly complied with, may result in personal injury or property damage.

— **⚠ CAUTION ⚠** —

After this heading, you can read instructions that, if not strictly complied with, could result in damage to equipment and/or property.

NOTE:

After this heading, you can read explanatory statements that require special emphasis.

These safety warnings cannot eliminate the hazards that they indicate. Common sense and strict compliance with the special instructions while performing the service are essential to preventing accidents.

Four commonly used safety symbols accompany the DANGER, WARNING and CAUTION blocks. The type of information each indicates follows:

- ⚠** This symbol points out important safety information that, if not followed, could endanger personal safety and/or property of you and others.
- 💣** This symbol points out potential explosion hazard.
- 🔥** This symbol points out potential fire hazard.
- ⚡** This symbol points out potential electrical shock hazard.

⚠ GENERAL HAZARDS ⚠

- Any AC generator that is used for backup power if a NORMAL (utility) power source failure occurs, must be isolated from the NORMAL (utility) power source by means of an approved transfer switch. Failure to properly isolate the NORMAL and STANDBY power sources from each other may result in injury or death to electric utility workers, due to backfeed of electrical energy.
- Improper or unauthorized installation, operation, service or repair of the equipment is extremely dangerous and may result in death, serious personal injury, or damage to equipment and/or personal property.
- Extremely high and dangerous power voltages are present inside an installed transfer switch. Any contact with high voltage terminals, contacts or wires will result in extremely hazardous, and possibly LETHAL, electric shock. **DO NOT WORK ON THE TRANSFER SWITCH UNTIL ALL POWER VOLTAGE SUPPLIES TO THE SWITCH HAVE BEEN POSITIVELY TURNED OFF.**
- Competent, qualified personnel should install, operate and service this equipment. Adhere strictly to local, state and national electrical and building codes. When using this equipment, comply with regulations the National Electrical Code (NEC), CSA Standard; C22.1 Canadian Electric Code and Occupational Safety and Health Administration (OSHA) have established.
- Never handle any kind of electrical device while standing in water, while barefoot, or while hands or feet are wet. **DANGEROUS ELECTRICAL SHOCK MAY RESULT.**

- Because jewelry conducts electricity, wearing it may cause dangerous electrical shock. Remove all jewelry (such as rings, watches, bracelets, etc.) before working on this equipment.
- If you must work on this equipment while standing on metal or concrete, place insulative mats over a dry wood platform. Work on this equipment only while standing on such insulative mats.
- Never work on this equipment while physically or mentally fatigued.
- Keep the transfer switch enclosure door closed and bolted at all times. Only qualified personnel should be permitted access to the switch interior.
- In case of an accident caused by electric shock, immediately shut down the source of electrical power. If this is not possible, attempt to free the victim from the live conductor but AVOID DIRECT CONTACT WITH THE VICTIM. Use a nonconducting implement, such as a rope or board, to free the victim from the live conductor. If the victim is unconscious, apply first aid and get immediate medical help.
- When an automatic transfer switch is installed for a standby generator set, the generator engine may crank and start at any time without warning. To avoid possible injury that might be caused by such sudden start-ups, the system's automatic start circuit must be disabled before working on or around the generator or transfer switch. For that purpose, a SAFETY DISCONNECT is provided inside the transfer switch. Always set that switch to its MANUAL position before working on the equipment. Then place a "DO NOT OPERATE" tag on the transfer switch and on the generator. Remove the Negative (Neg) or (-) battery cable.

Safety Rules.....Inside Front Cover

Section 1 – General Information2

1.1 Introduction2

1.2 Equipment Description2

1.3 Transfer Switch Data Plate2

1.4 Transfer Switch Enclosure2

1.5 Safe Use Of Transfer Switch2

Section 2 – Installation3

2.1 Introduction to Installation3

2.2 Unpacking3

2.3 Mounting3

2.4 Connecting Power Source and Load Lines.....3

 2.4.1 2-Pole Mechanism3

 2.4.2 3-Pole Mechanism3

2.5 Connecting Start Circuit Wires4

2.6 Auxiliary Contacts4

Section 3 – Operation5

3.1 Functional Tests & Adjustments5

3.2 Manual Operation5

 3.2.1 Close to Normal Source Side5

 3.2.2 Close to Emergency Source Side.....5

 3.2.3 Return to Normal Source Side5

3.3 Voltage Checks.....5

3.4 Generator Tests Under Load7

Section 4 – Mounting Dimensions8

Section 5 – Electrical Data9

Section 6 – Exploded Views & Parts Lists12

Section 7 – WarrantyBack Cover

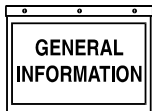

1.1 INTRODUCTION

This manual has been prepared especially for the purpose of familiarizing personnel with the design, application, installation, operation and servicing of the applicable equipment. Read the manual carefully and comply with all instructions. This will help to prevent accidents or damage to equipment that might otherwise be caused by carelessness, incorrect application, or improper procedures.

Every effort has been expended to make sure that the contents of this manual are both accurate and current. Generac, however, reserves the right to change, alter or otherwise improve the product at any time without prior notice.

1.2 EQUIPMENT DESCRIPTION

The automatic transfer switch is used for transferring critical electrical load from a UTILITY (Normal) power source to a EMERGENCY (Standby generator) power source. Such a transfer of electrical loads occurs automatically when the UTILITY power source has failed or is substantially reduced and the EMERGENCY source voltage and frequency have reached an acceptable level. The transfer switch prevents electrical feedback between two different power sources (such as the UTILITY and EMERGENCY sources) and, for that reason, codes require it in all standby electric system installations.

The transfer switch consists of a solid state intelligence circuit, a transfer mechanism and a control panel.

1.3 TRANSFER SWITCH DATA DECAL

A DATA DECAL is permanently affixed to the transfer switch enclosure. Use this transfer switch only with the specific limits shown on the DATA DECAL and on other decals and labels that may be affixed to the switch. This will prevent damage to equipment and property.

When requesting information or ordering parts for this equipment, make sure to include all information from the DATA DECAL.

Record your Model and Serial numbers in the space provided below for future reference.

ASSEMBLY #
SERIAL #

1.4 TRANSFER SWITCH ENCLOSURE

The standard switch enclosure is a National Electrical Manufacturer’s Association (NEMA) 3R type. NEMA 3R type enclosures primarily provide a degree of protection against falling rain and sleet; undamaged by the formation of ice on the enclosure.

1.5 SAFE USE OF TRANSFER SWITCH

Before installing, operating or servicing this equipment, read the SAFETY RULES (inside front cover) carefully. Comply strictly with all SAFETY RULES to prevent accidents and/or damage to the equipment. Generac recommends you make a copy of the SAFETY RULES and post them near the transfer switch. Also, be sure to read all instructions and information you may find on tags, labels and decals affixed to the equipment.

Two publications that outline the safe use of transfer switches are the following:

- NFPA 70; National Electrical Code
- UL 1008, STANDARD FOR SAFETY-AUTOMATIC TRANSFER SWITCHES



2.1 INTRODUCTION TO INSTALLATION

This equipment has been wired and tested at the factory. Installing the switch includes the following procedures:

- Mounting the enclosure.
- Connecting power source and load leads.
- Connecting the generator start circuit.
- Connecting any auxiliary contact (if needed)
- Installing/connecting any options and accessories.
- Testing functions.

2.2 UNPACKING

Carefully unpack the transfer switch. Inspect closely for any damage that might have occurred during shipment. The purchaser must file with the carrier any claims for loss or damage incurred while in transit.

Check that all packing material is completely removed from the switch prior to installation.

2.3 MOUNTING

Mounting dimensions for the transfer switch enclosure are in this manual. Enclosures are typically wall-mounted. See “Mounting Dimensions” on page 8.



Handle transfer switches carefully when installing. Do not drop the switch. Protect the switch against impact at all times, and against construction grit and metal chips. Never install a transfer switch that has been damaged.

Install the transfer switch as close as possible to the electrical loads that are to be connected to it. Mount the switch vertically to a rigid supporting structure. To prevent switch distortion, level all mounting points. If necessary, use washers behind mounting holes to level the unit.

2.4 CONNECTING POWER SOURCE AND LOAD LINES



Make sure to turn OFF both the UTILITY (Normal) and EMERGENCY (Standby generator) power supplies before trying to connect power source and load lines to the transfer switch. Supply voltages are extremely high and dangerous. Contact with such high voltage power supply lines causes extremely hazardous, possibly lethal, electrical shock.

Wiring diagrams and electrical schematics are provided in this manual. Power source and load connections are made at a transfer mechanism, inside the switch enclosure.

◆ 2.4.1 2-POLE MECHANISM

These switches (Figure 2.1) are used with a single phase system, when the single phase NEUTRAL line is to be connected to a Neutral Lug and is not to be switched.

Figure 2.1 — Typical 2-Pole Transfer Mechanism (100 Amp Shown)

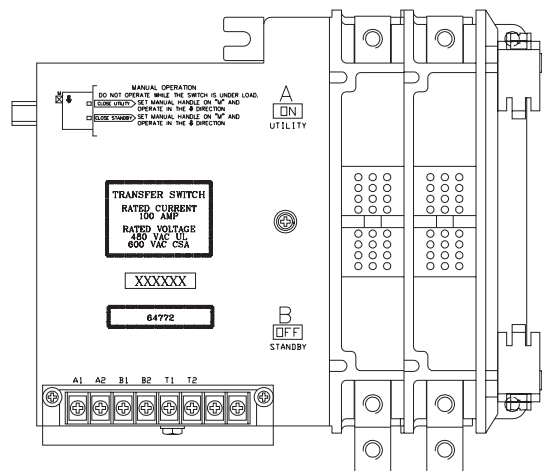

◆ 2.4.2 3-POLE MECHANISM

These switches (Figure 2.2) are used with a three phase system, when the three phase NEUTRAL line is to be connected to a NEUTRAL lug and is not to be switched. It is also used with a single phase system when the neutral is to be switched (NEUTRAL to be connected to third pole).

Figure 2.2 — Typical 3-Pole Transfer Mechanism (200 Amp Shown)

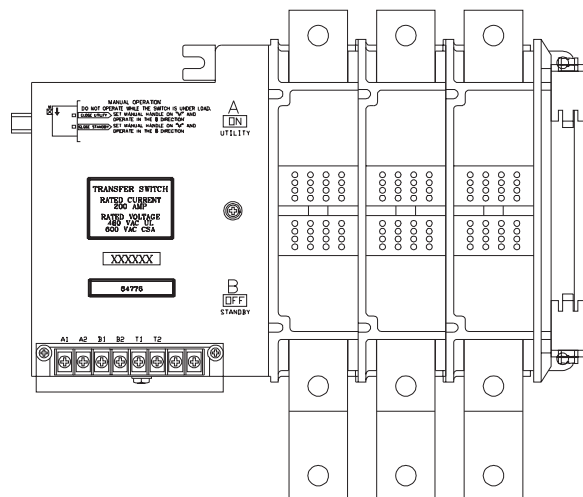

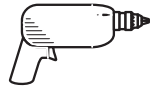

Solderless, screw-type terminal lugs are standard.

The conductor size range is as follows:

Switch Rating	Wire Range
200A	#4-400 MCM

Conductor sizes must be adequate to handle the maximum current to which they will be subjected; based on the 75°C column of tables, charts, etc. used to size conductors. The installation must comply fully with all applicable codes, standards and regulations.

Before connecting wiring cables to terminals, remove any surface oxides from the cable ends with a wire brush. All power cables should enter the switch next to transfer mechanism terminals. If ALUMINUM conductors are used, apply corrosion inhibitor to conductors. Tighten terminal lugs to the torque values as noted on the decal located on the inside of the door. After tightening terminal lugs, carefully wipe away any excess corrosion inhibitor.

All power cables should enter the switch next to the transfer mechanism terminals.



Use a torque wrench to tighten the conductors, being sure not to overtighten, or damage to the switch base could occur. If undertightened, a loose connection would result, causing excess heat which could damage the switch base.

Connect power source load conductors to clearly marked transfer mechanism terminal lugs as follows

1. Connect utility (NORMAL) power source cables to switch terminals N1, N2, N3.
2. Connect emergency (STANDBY) source power cables to transfer switch terminals E1, E2, E3.
3. Connect customer LOAD leads to switch terminals T1, T2, T3.

Conductors must be properly supported, of approved insulative qualities, protected by approved conduit, and of the correct wire gauge size in accordance with applicable codes.

Be sure to maintain proper electrical clearance between live metal parts and grounded metal. Allow at least 1/2 inch for 100-400 amp circuits; at least 1 inch for circuits over 400 amps.

2.5 CONNECTING START CIRCUIT WIRES

Control system interconnections (Page 11) consist of UTILITY 1 and 2, LOAD 1 and 2; and leads 23 and 194. Control system interconnection leads must be run in a conduit that is separate from the AC power lead. Recommended wire gauge sizes for this wiring depends on the length of the wire, as recommended below:

MAXIMUM WIRE LENGTH	RECOMMENDED WIRE SIZE
460 feet (140m)	No. 18 AWG.
461 to 730 feet (223m)	No. 16 AWG.
731 to 1,160 feet (354m)	No. 14 AWG.
1,161 to 1,850 feet (565m)	No. 12 AWG.

2.6 AUXILIARY CONTACTS

If desired, there are Auxiliary Contacts on the transfer switch to operate customer accessories, remote advisory lights, or remote annunciator devices. A suitable power source must be connected to the COMMON (C) terminal. See Figure 2.3.

Contact operation is shown in the following chart:

	Switch Position	
	Utility	Standby
Common to Normally Open	Open	Closed
Common to Normally Closed	Closed	Open

NOTE:

Auxiliary Contacts are rated 10 amps at 125 or 250 volts AC. DO NOT EXCEED THE RATED VOLTAGE AND CURRENT OF THE CONTACTS.

Figure 2.3 – Auxiliary Contacts

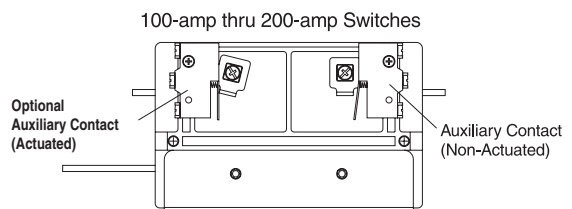

Side views shown in Utility position

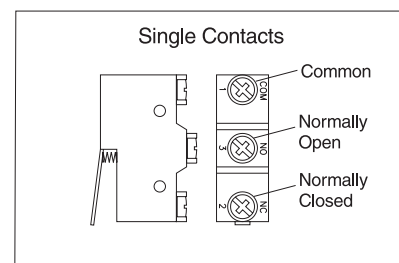

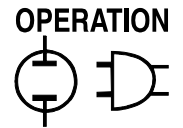

3.1 FUNCTIONAL TESTS AND ADJUSTMENTS

Following transfer switch installation and interconnection, inspect the entire installation carefully. A competent, qualified electrician should inspect it. The installation should comply strictly with all applicable codes, standards, and regulations. When absolutely certain the installation is proper and correct, complete a functional test of the system.



 Perform functional tests in the exact order presented in this manual, or you could damage the switch.

IMPORTANT: Before proceeding with functional tests, read and make sure you understand all instructions and information in this section. Also read the information and instructions of labels and decals affixed to the switch. Note any options or accessories that might be installed and review their operation.

3.2 MANUAL OPERATION



 Do NOT manually transfer under load. Disconnect transfer switch from all power sources by approved means, such as a main circuit breaker(s).

A manual HANDLE is shipped with the transfer switch. Manual operation must be checked BEFORE the transfer switch is operated electrically. To check manual operation, proceed as follows:

1. Turn the generator’s Manual-Off-Auto switch to OFF.
2. Turn OFF both utility and emergency power supplies to the transfer switch, with whatever means provided (such as the main line circuit breakers).
3. Note position of transfer mechanism main contacts by observing display windows in “A” and “B” in Figure 3.1 on page 6 as follows:
 - Window “A” ON, Window “B” OFF - LOAD terminals (T1, T2, T3) are connected to utility terminals (N1, N2, N3).
 - Window “A” OFF, Window “B” ON - LOAD terminals (T1, T2, T3) are connected to emergency terminals (E1, E2, E3).



 Do not use excessive force when operating the transfer switch manually or you could damage the manual handle.

◆ 3.2.1 CLOSE TO NORMAL SOURCE SIDE

Before proceeding, verify the position of the switch by observing window “A” in Figure 3.1 on page 6. If window “A” reads “ON”, the contacts are closed in the normal position, no further action is required. If it reads “OFF”, proceed with Step 1.

Step 1: With the handle attached to the actuating shaft, move handle in the direction of the arrow on the switch cover until it stops — DO NOT FORCE. Release handle slowly to allow the spring in the switch box to relax. “ON” now appears in Window “A” and “OFF” appears in Window “B”.

◆ 3.2.2 CLOSE TO EMERGENCY SOURCE SIDE

Before proceeding, verify the position of the switch by observing window “B” in Figure 3.1 on page 6. If window “B” reads “ON”, the contacts are closed in the EMERGENCY (Standby) position. No further action is required. If it reads “OFF”, proceed with Step 1.

Step 1: With the handle attached to the actuating shaft, move the handle in the direction of the arrow on the switch cover until it stops - DO NOT FORCE. Release handle slowly to allow the spring in the switch box to relax. “OFF” now appears in Window “A” and “ON” appears in Window “B”.

◆ 3.2.3 RETURN TO NORMAL SOURCE SIDE

Manually actuate switch to return Window “A” to the “ON” position.

3.3 VOLTAGE CHECKS

1. Turn ON the UTILITY power supply to the transfer switch with whatever means provided (such as the UTILITY main line circuit breaker).



PROCEED WITH CAUTION. THE TRANSFER SWITCH IS NOW ELECTRICALLY HOT. CONTACT WITH LIVE TERMINALS RESULTS IN EXTREMELY HAZARDOUS AND POSSIBLY FATAL ELECTRICAL SHOCK.

2. With an accurate AC voltmeter, check for correct voltage.

Single-phase utility supply:

Measure across ATS terminal lugs N1 and N2; N1 to NEUTRAL and N2 to NEUTRAL.

Three-phase utility supply:

Measure across ATS terminal lugs N1 to N2, N2 to N3, and N1 to N3.

Measure across ATS terminal lugs N1 to NEUTRAL, N2 to NEUTRAL, and N3 to NEUTRAL.

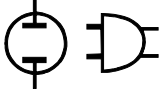
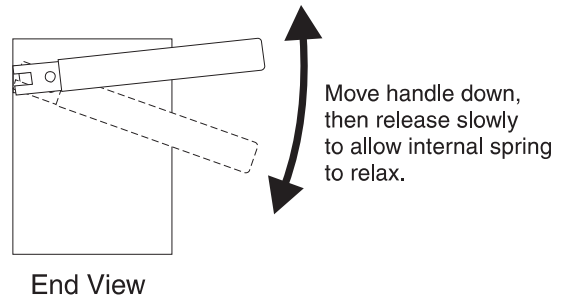
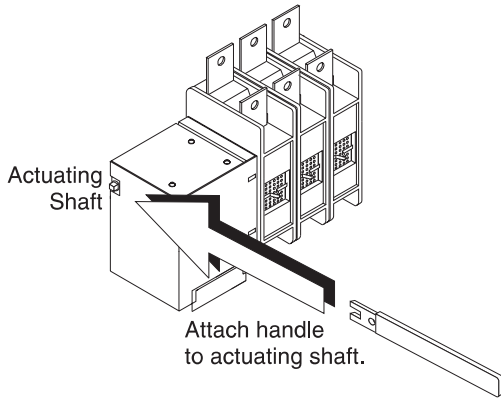
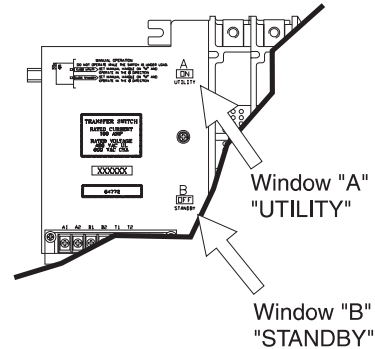
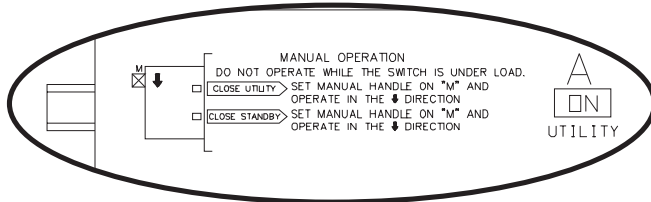

Figure 3.1 — Actuating Transfer Switch



DANGER: Do NOT manually transfer under load. Disconnect transfer switch from all power sources by approved means, such as a main circuit breaker(s).

Detail of instructions printed on transfer switch



NOTE: Return handle to storage position in enclosure when finished with manual transfer

3. When certain that UTILITY supply voltage is correct and compatible with transfer switch ratings, turn OFF the UTILITY supply to the transfer switch.
4. On the generator panel, set the Manual-Off-Auto switch to MANUAL position. The generator should crank and start.
5. Let the generator stabilize and warm up at no-load for at least five minutes.
6. Set the generator's main circuit breaker (CB1) to its ON or CLOSED position.



PROCEED WITH CAUTION. GENERATOR OUTPUT VOLTAGE IS NOW BEING DELIVERED TO TRANSFER SWITCH TERMINALS. CONTACT WITH LIVE TERMINALS RESULTS IN EXTREMELY DANGEROUS AND POSSIBLY FATAL ELECTRICAL SHOCK.

7. With an accurate AC voltmeter and frequency meter, check the no-load, voltage and frequency.

Single-phase generator supply:

Measure across ATS terminal lugs E1 to E2; E1 to NEUTRAL and E2 to NEUTRAL.

- a. Frequency60-62 Hz
- b. Terminals E1 to E2240-246 VAC
- c. Terminals E1 to NEUTRAL120-123 VAC
- d. Terminals E2 to NEUTRAL120-123 VAC

Three-phase generator supply:

Measure across ATS terminal lugs E1 to E2, E2 to E3 and E1 to E3.

Measure across ATS terminal lugs E1 to NEUTRAL, E2 to NEUTRAL and E3 to NEUTRAL.

- a. Frequency60-62 Hz
- b. Terminals E1-E2, E2-E3, E1-E3208-212 VAC
- c. Terminals E1-N, E2-N, E3-N120-122 VAC

It will also be necessary to verify that the phase rotation of the utility matches the phase rotation of the generator. This can be done by using a phase rotation indicator.

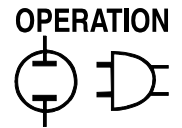

—▲ CAUTION ▲—

▲ Failure to do so may result in damage to certain rotary equipment.

8. Set the generator's main circuit breaker (CB1) to its OFF or OPEN position.
9. Set the Auto/Off/Manual switch to the OFF position to shut down the generator.

NOTE:

Do NOT proceed until generator AC output voltage and frequency are correct and within stated limits. If the no-load voltage is correct but no-load frequency is incorrect, the engine governed speed probably requires adjustment. If no-load frequency is correct but voltage is not, the voltage regulator may require adjustment.

3.4 GENERATOR TESTS UNDER LOAD

1. Set the generator's main circuit breaker to its OFF or OPEN position.
2. Manually actuate the transfer switch main contacts to their emergency (Standby) position. Refer to Manual Operation on page 5.
3. To start the generator, set the Manual-Off-Auto switch to MANUAL. When engine starts, let it stabilize for a few minutes.
4. Turn the generator's main circuit breaker to its ON or CLOSED position. The generator now powers all LOAD circuits. Check generator operation under load as follows:

- Turn ON electrical loads to the full rated wattage/ampere capacity of the generator. DO NOT OVERLOAD.
 - With maximum rated load applied, check voltage and frequency across transfer switch terminals E1 and E2. Voltage should be greater than 230 volts; frequency should be greater than 59 Hz.
 - Let the generator run under rated load for at least 30 minutes. With unit running, listen for unusual noises, vibration, overheating, etc., that might indicate a problem.
5. When checkout under load is complete, set main circuit breaker of the generator to its OFF or OPEN position.
 6. Let the generator run at no-load for several minutes. Then, shut down by setting the Manual-Off-Auto switch to its OFF position.
 7. Move the switch's main contacts back to their utility position. For example, load connected to utility power supply. Refer to Manual Operation on page 5. Handle and operating lever of transfer switch should be in down position.
 8. Turn on the utility power supply to transfer switch, using whatever means provided (such as a utility main line circuit breaker). The utility power source now powers the loads.
 9. Set the generator's Auto/Off/Manual switch to its AUTO position. The system is now set for fully automatic operation.

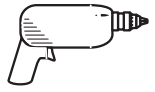

Section 4 – Mounting Dimensions

Generac GTS "W" Type Transfer Switch

Mounting Dimensions – Drawing No. OD3714-B

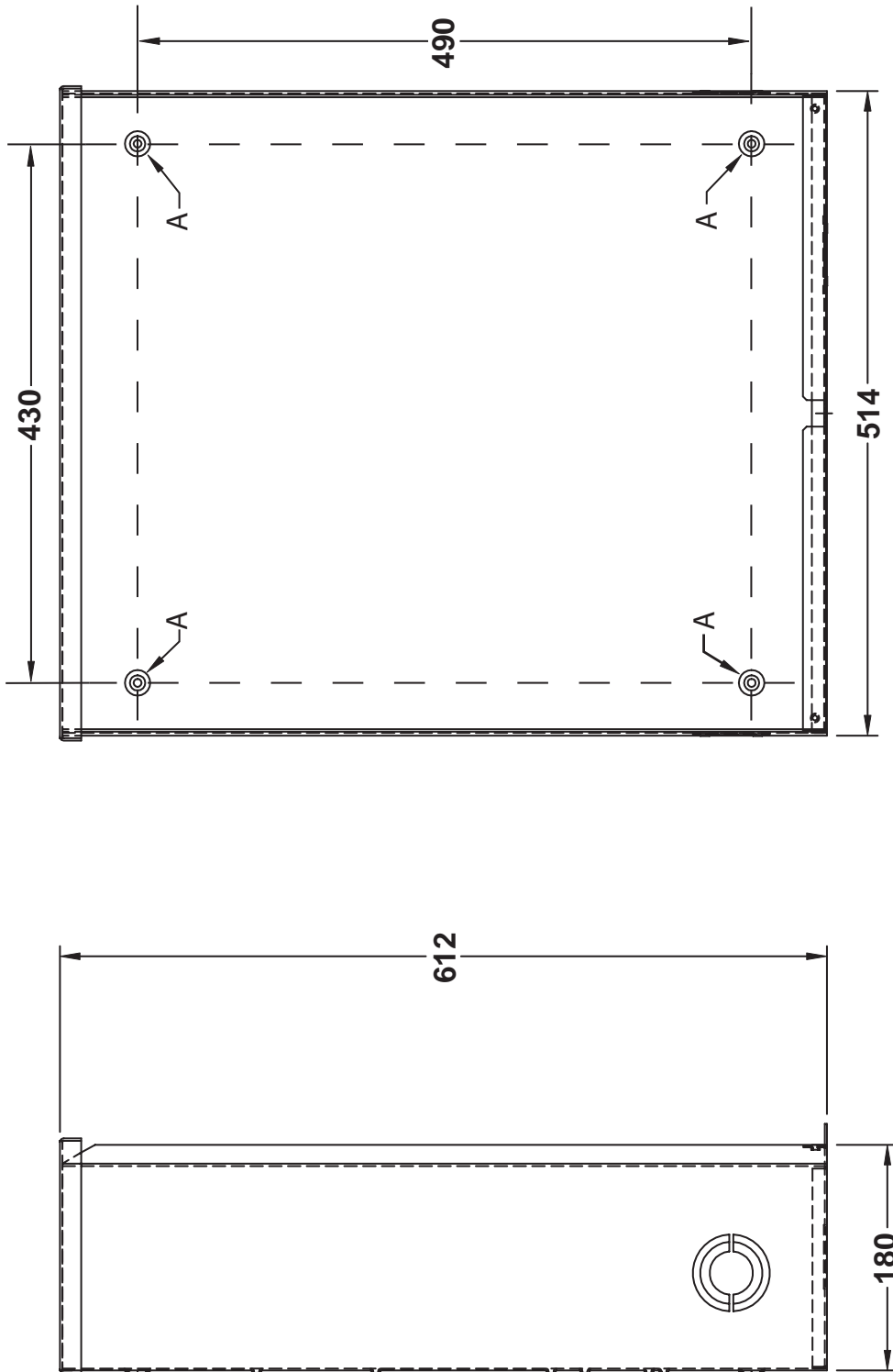

Values are in Millimeters

Note: Diameter of Mounting holes (A) is 6.35 MM

Section 5 – Electrical Data
Generac GTS "W" Type Transfer Switch
200 Amp, 2-pole Switch – Drawing No. 0D3819

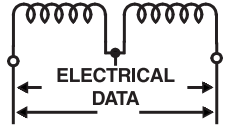

WIRING DIAGRAM

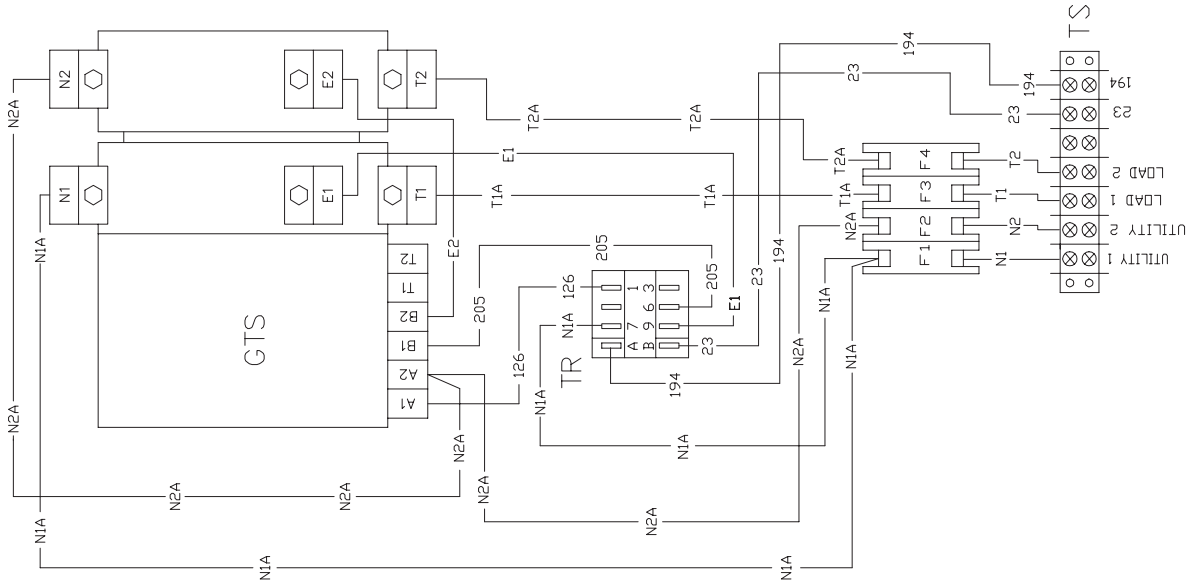

SCHEMATIC DIAGRAM

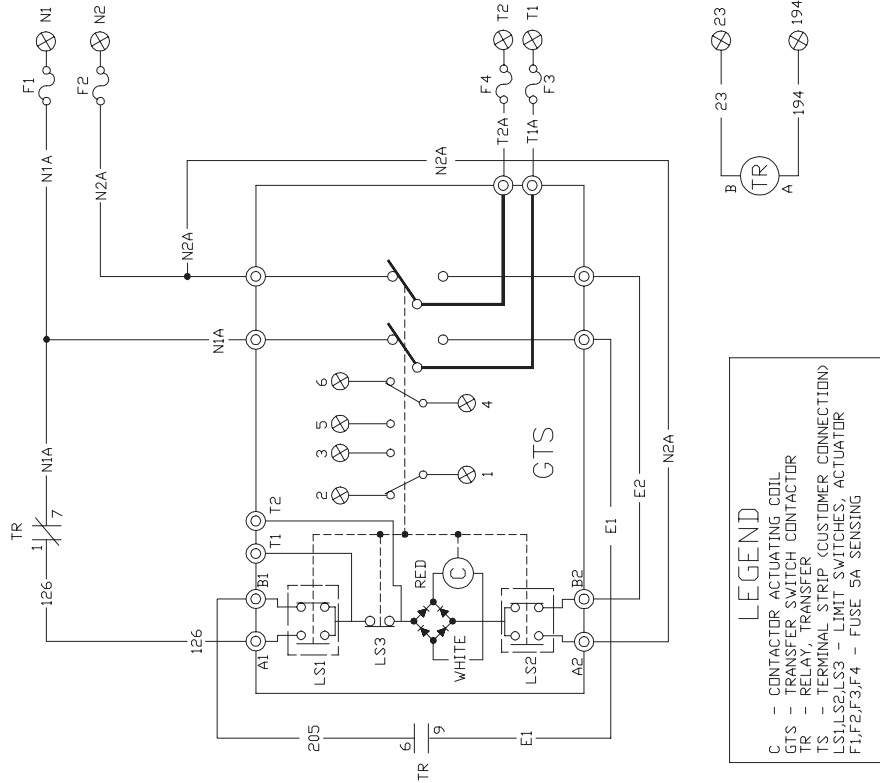

LEGEND
 C - CONTACTOR ACTUATING COIL
 GTS - TRANSFER SWITCH CONTACTOR
 TR - RELAY TRANSFER
 TS - TERMINAL STRIP (CUSTOMER CONNECTION)
 LS1,LS2,LS3 - LIMIT SWITCHES, ACTUATOR
 FL,F2,F3,F4 - FUSE 5A SENSING

NOTES:
 ALL CONTACTS SHOWN WITH
 TRANSFER SWITCH IN UTILITY
 POSITION.

Section 5 – Electrical Data
Generac GTS "W" Type Transfer Switch
Transfer Switch Interconnections

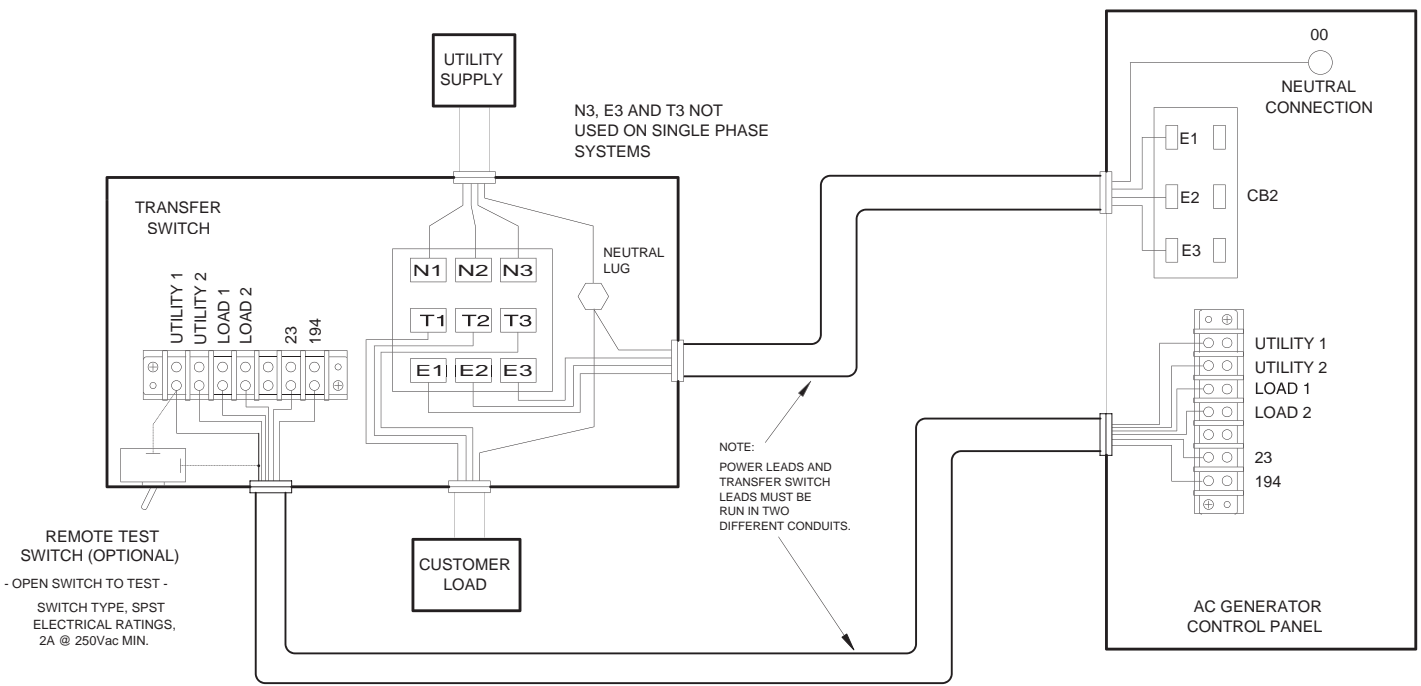
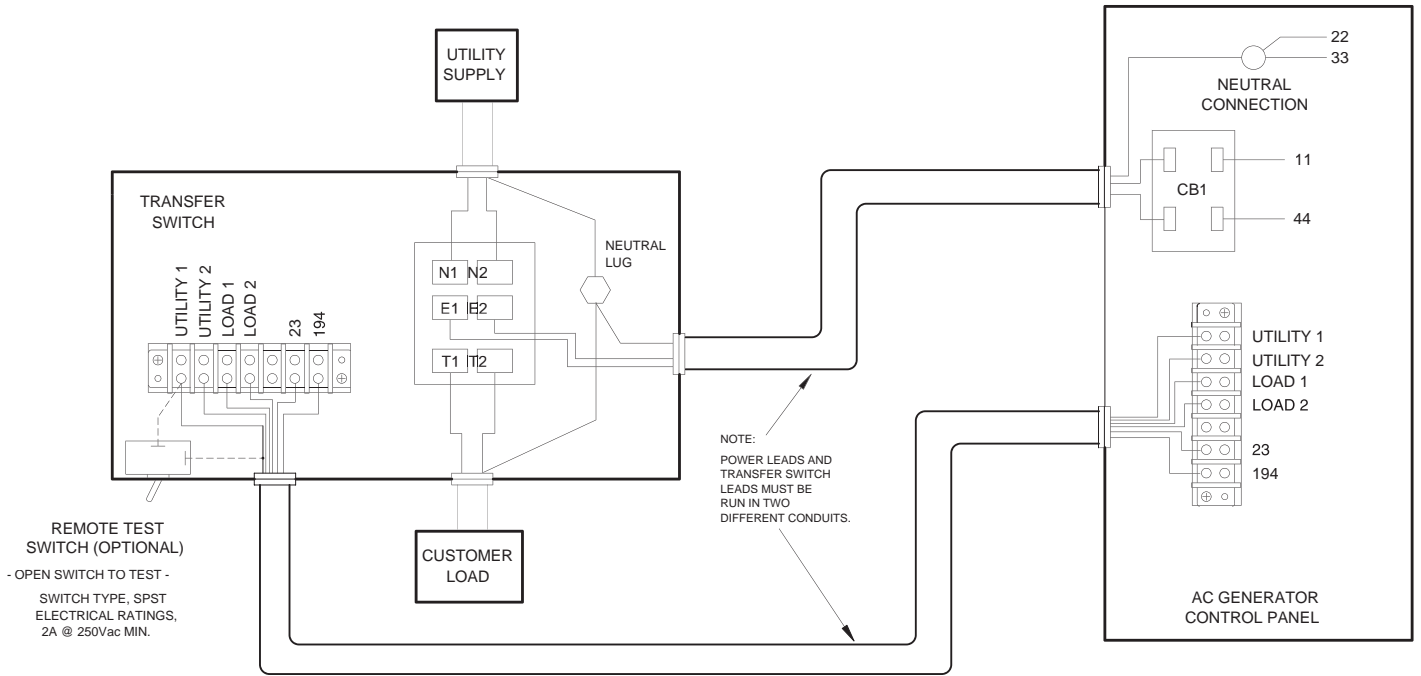
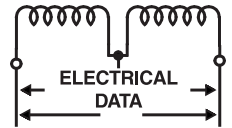



Section 6 – Exploded Views and Parts List

Generac GTS "W" Type Transfer Switch

Transfer Switch Assembly – Drawing No. 0D4406-C

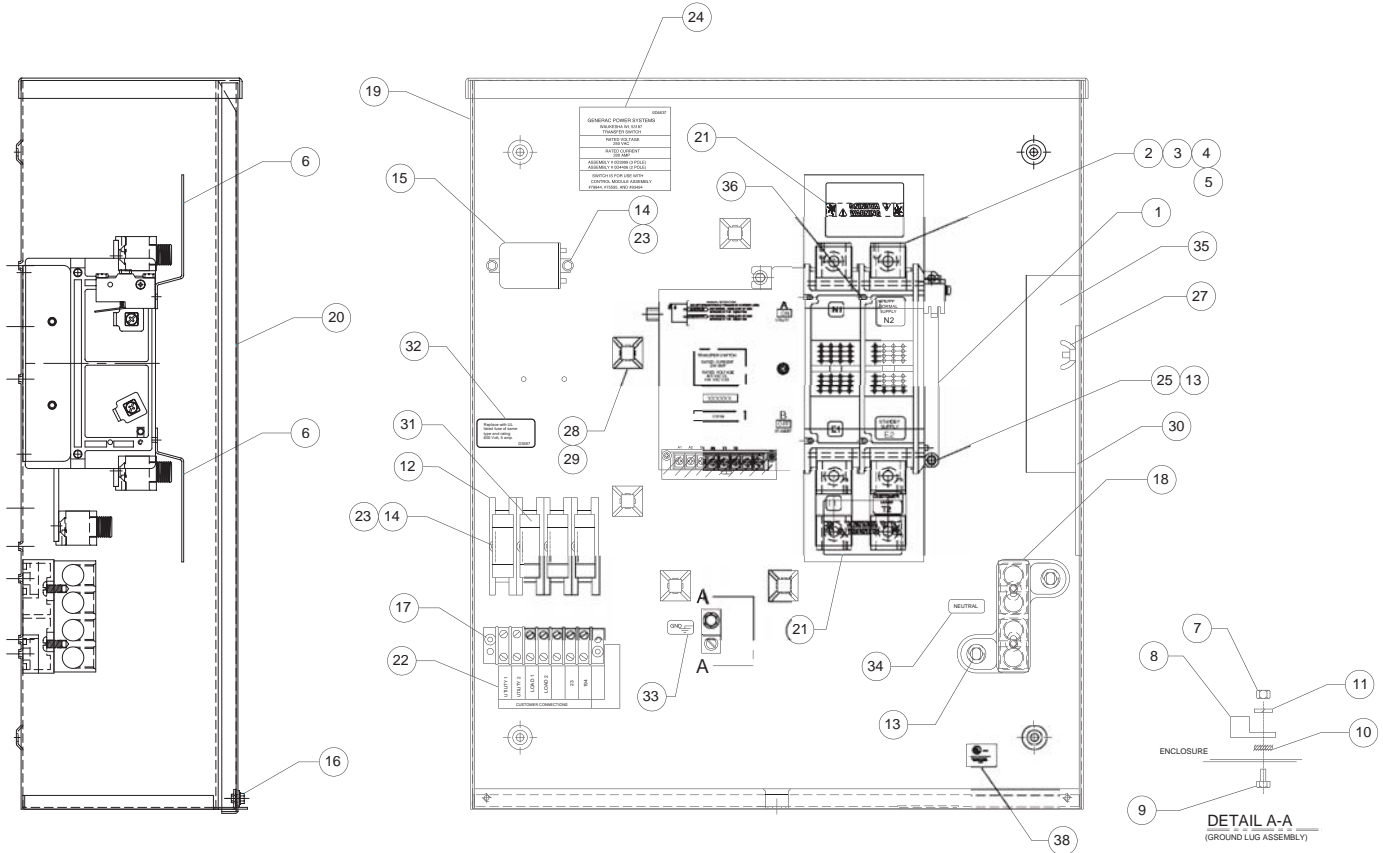

ITEM	PART NO.	QTY.	DESCRIPTION	ITEM	PART NO.	QTY.	DESCRIPTION
1	0C8884	1	XFER SW-W 200A600V2P	21	0C8308	2	DECAL TERMINAL SHOCK HAZARD
2	0A9949	6	LUG SLDLSS 400-#4X1/4-20 CU7AL	22	0A2595	1	DECAL, TERM. STRIP
3	0C4896	6	SCREW FHMS M8-1.25 X 20MM CR	23	022264	6	WASHER LOCK #8-M4
4	067989	6	NUT LOCK FL M8-1.25 YEL CHR	24	0D4637	1	DECAL, SWITCH RATING
5	026902	6	SCREW HHTT #8-32 X 1/4 CZ	25	022097	3	WASHER LOCK M6-1/4
6	0C7907H	2	LUG COV2P 150/200AMP	26			
7	022259	1	NUT HEX 5/16-18 STEEL	27	025870	1	NUT WING 1/4-20
8	057329	1	LUG SLDLSS 350-#6X13/32 AL/CU	28	057593	5	CABLE TIE MOUNT BLACK
9	022142	1	SCREW HHC 5/16-18 X 3/4 G5	29	028739	5	TIE WRAP 3.9" X .10" NAT'L UL
10	027482	1	WASHER SHAKEPROOF EXT 5/16 STL	30	063321	1	HANDLE XFER SWITCH 1-400A
11	022129	1	WASHER LOCK M8-5/16	31	073590A	4	FUSE 5A X BUSS
12	073591	4	FUSE HOLDER	32	0D3587	1	DECAL, FUSE REPLACEMENT
13	090388	5	SCREW HHTT M6-1.0 X 12 YC	33	067210A	1	DECAL GROUND LUG
14	0A1495	6	SCREW HHTT M4-0.7 X 10 BP	34	0A9457	1	DECAL NEUTRAL
15	063617	1	RELAY PNL 12VDC DPDT 10A@240VA	35	0D4545	1	DECAL, MANUAL OPERATION
16	0A7215	2	SCREW SW 1/4-20X5/8 N WA JS500	36	0C8275	4	SCREW PPHM DSEMS M4-7 X 10 ZNC
17	0A1661	2	RIVET POP .156 X .160-.164#20	37*	0D3305	1	DECAL, TEST SEQUENCE 2P TS
18	0C4449A	1	ASS'Y-NTRL BL150-200A	38	081221	1	DECAL-UL LIST HSB
19	0D3714	1	WELDMENT, TRANSFER SWITCH BOX				
20	0D5589	1	SILK SCREEN, ATS COVER				

*CENTER DECAL ON INSIDE OF THE COVER (ITEM #20)

Section 6 – Exploded Views and Parts List
Generac GTS "W" Type Transfer Switch
200 A, 3-pole Switch – Drawing No. OD3999-B

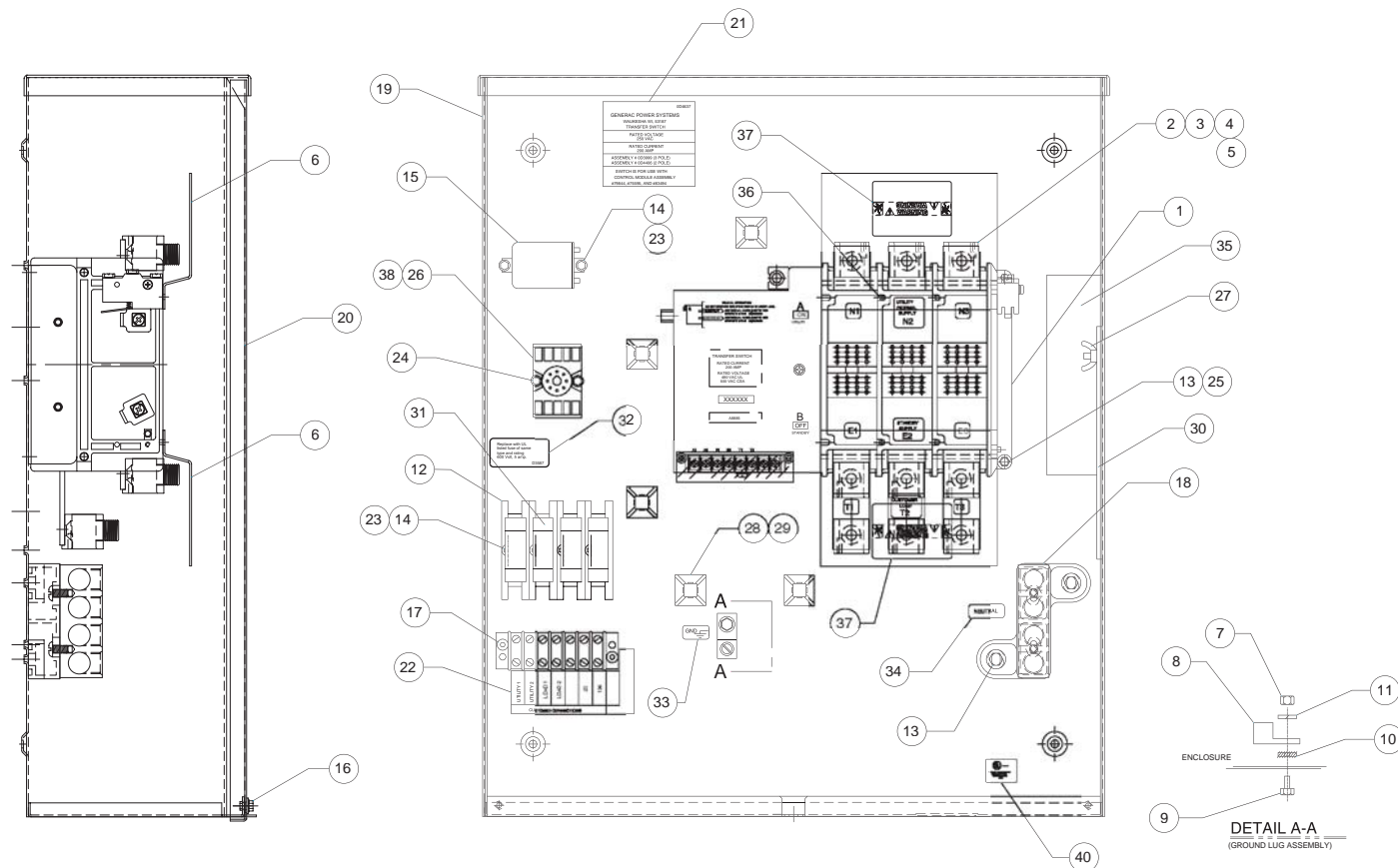
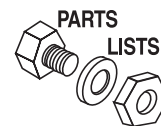

ITEM	PART NO.	QTY.	DESCRIPTION
1	OC8885	1	SWITCH, TRANSFER 3-POLE
2	0A9949	9	LUG SOLDERLESS 400-#4 X 1/4-20 CU7AL
3	OC4896	9	CRFHMS M8-1.25
4	067989	9	NUT LOCKING M8-1.25
5	026902	7	SCREW TAPTITE #8-32 X 1/4 BP
6	OC7907D	2	LUG COV2P 150/200 AMP
7	022259	1	NUT HEX 5/16-18 STEEL
8	057329	1	LUG SOLDERLESS 350-#6 X 13/32 AL/CU
9	022142	1	SCREW, HHC 5/16-18 X 3/4 G5
10	027482	1	WASHER SHAKEPROOF EXT 5/16 STEEL
11	022129	1	WASHER LOCK M8-5/16
12	073591	4	FUSE HOLDER
13	090388	5	SCREW TAPTITE M6-1.0 X 12MM
14	0A1495	6	SCREW TAPTITE M4-.7 X 10MM
15	063617	1	RELAY PNL 12VDC DPDT 10A@240VA
16	0A7215	2	SCREW, SWAGE 1/4-20 X 5/8" NYLON
17	0A1661	2	RIVET, POP
18	OC4449A	1	ASSY. NEUTRAL BLOCK 200A
19	OD3714	1	BOX TRANSFER SWITCH
20	OD5589	1	SILKSCREEN COVER TRANSFER SWITCH

ITEM	PART NO.	QTY.	DESCRIPTION
21	OD4637	1	DECAL, SWITCH RATING
22	0A2595	1	DECAL, TERMINAL STRIP
23	022264	6	WASHER, LOCK #8-M4
24	0A2284	2	SCREW, SWAGE #8-32 X 1/2 Z/YC
25	022097	3	WASHER, LOCK M6-1/4
26	063306	1	3-PHASE POWER MONITOR
27	025870	1	NUT WING 1/4-20 X .33
28	057593	5	HOLDER CABLE TIE
29	028739	5	TIE WRAP 4" WHITE
30	063321	1	HANDLE TRANSFER SWITCH 1-400A
31	073590A	4	FUSE 5A X BSS HLD73591
32	OD3587	1	DECAL, FUSE REPLACEMENT
33	067210A	1	DECAL, GROUNDING LUG
34	0A9457	1	DECAL, NEUTRAL
35	OD4545	1	DECAL, MANUAL OPERATION
36	OC8275	4	SCREW PPHM DSEMS M4-.7 X 10 ZNC
37	OC8308	2	DECAL TERMINAL SHOCK HAZARD
38	066972	1	RELAY SOCKET
*39	OD3305	1	DECAL TEST SEQUENCE
40	081221	1	DECAL UL NAMEPLATE



Section 7 – Warranty

Generac GTS "W" Type Transfer Switch

GENERAC POWER SYSTEMS STANDARD TWO-YEAR LIMITED WARRANTY FOR GENERAC TRANSFER SWITCH SYSTEMS

NOTE: ALL UNITS MUST HAVE A START-UP INSPECTION PERFORMED BY AN AUTHORIZED GENERAC DEALER.

For a period of 2 (two) years from the date of sale/start date, Generac Power Systems, Inc. will, at its option, repair or replace any part(s) which, upon examination, inspection, and testing by Generac Power Systems or a Generac Power Systems Authorized Warranty Service Facility, is found to be defective under normal use and service, in accordance with the warranty schedule set forth below. Any equipment that the purchaser/owner claims to be defective must be returned to, and examined by the nearest Generac Power Systems Authorized Warranty Service Facility. All transportation costs under the warranty, including return to the factory, are to be borne and prepaid by the purchaser/owner. This warranty applies only to Generac Power Systems Transfer Switch applications, as Generac Power Systems, Inc. have defined Transfer Switch application, provided said Transfer Switch has been initially installed and inspected on-site by a Generac Power Systems Authorized Service Dealer or branch thereof. A scheduled maintenance agreement with a local Authorized Generac Power Systems Dealer is highly recommended to verify adequate service has been performed on the unit throughout the warranty period.

WARRANTY SCHEDULE

- **YEAR ONE** — 100% (one hundred percent) coverage on mileage*, labor, and parts listed.
- **ALL COMPONENTS**
- **YEAR TWO** — 100% (one hundred percent) coverage on parts listed.
- **ALL COMPONENTS — *PARTS ONLY**
- *Travel allowance is limited to 300 miles maximum, or 7.5 hours maximum (per occurrence), **round trip**, to the nearest authorized Generac Service Facility.
- A Generac Power Systems, Inc. Transfer Switch is highly recommended to be used in conjunction with the genset. If a non Generac genset is substituted for use and directly causes damage to the Generac Transfer Switch, no warranty coverage shall apply.
- All warranty expense allowances **are** subject to the conditions defined in Generac Power Systems Warranty, Policies, and Procedures Flat Rate Manual.
- Units that have been resold **are not** covered under the Generac Power Systems Warranty, as this Warranty **is not** transferable.

THIS WARRANTY SHALL NOT APPLY TO THE FOLLOWING:

1. Any unit built/manufactured prior to January 1, 2002.
2. Unit enclosure is only covered against rust or corrosion the first year of the warranty provision.
3. Costs of normal maintenance i.e. tune-ups, associated part(s), adjustments, loose/leaking clamps, installation and start-up.
4. Use of Non-Generac replacement part(s) will void the warranty in its entirety.
5. Any failure caused by contaminated fuels, oils, coolants/antifreeze or lack of proper fuels, oils or coolants/antifreeze.
6. Failures due, but not limited to, normal wear and tear, accident, misuse, abuse, negligence, or improper installation or sizing.
7. Failures caused by any external cause or act of God such as collision, fire, theft, freezing, vandalism, riot or wars, lightning, earthquake, windstorm, hail, volcanic eruption, water or flood, tornado, hurricane, terrorist acts or nuclear holocaust.
8. Products that are modified or altered in a manner not authorized by Generac Power Systems in writing.
9. Any incidental, consequential or indirect damages caused by defects in materials or workmanship, or any delay in repair or replacement of the defective part(s).
10. Failure due to misapplication, misrepresentation, or bi-fuel conversion.
11. Telephone, telegraph, teletype or other communication expenses.
12. Living or travel expenses of person(s) performing service, except as specifically included within the terms of a specific unit warranty period.
13. Rental equipment used while warranty repairs are being performed i.e. rental generators, cranes, etc..
14. Overtime labor or more than one person performing repairs.
15. Any and all expenses incurred investigating performance complaints unless defective Generac materials and or workmanship were the direct cause of the problem.
16. *Engine coolant heaters (block-heaters), heater controls and circulating pumps after the first year.
17. *Starting batteries, fuses, light bulbs, engine fluids, tires, brakes, and overnight freight cost for replacement part(s).

THIS WARRANTY IS IN PLACE OF ALL OTHER WARRANTIES, EXPRESSED OR IMPLIED, SPECIFICALLY, GENERAC POWER SYSTEMS MAKES NO OTHER WARRANTIES AS TO THE MERCHANTABILITY OR FITNESS FOR A PARTICULAR PURPOSE. Some states do not allow limitations on how long an implied warranty lasts, so the above limitation may not apply to you.

GENERAC POWER SYSTEMS ONLY LIABILITY SHALL BE THE REPAIR OR REPLACEMENT OF PART(S) AS STATED ABOVE. IN NO EVENT SHALL GENERAC POWER SYSTEMS BE LIABLE FOR ANY INCIDENTAL, OR CONSEQUENTIAL DAMAGES, EVEN IF SUCH DAMAGES ARE A DIRECT RESULT OF GENERAC POWER SYSTEMS, INC. NEGLIGENCE.

Some states do not allow the exclusion or limitation of incidental or consequential damages, so the above limitations may not apply to you. Purchaser/owner agrees to make no claims against Generac Power Systems, Inc. based on negligence. This warranty gives you specific legal rights. You also may have other rights that vary from state to state.

GENERAC® POWER SYSTEMS, INC. · P.O. BOX 8 · WAUKESHA, WI 53187

PH: (262) 544-4811 · FAX: (262) 544-4851

Bulletin 0166260SBY / Printed in USA 5.02