

# GENERAC®

## POWER SYSTEMS, INC.

### Owner's Manual

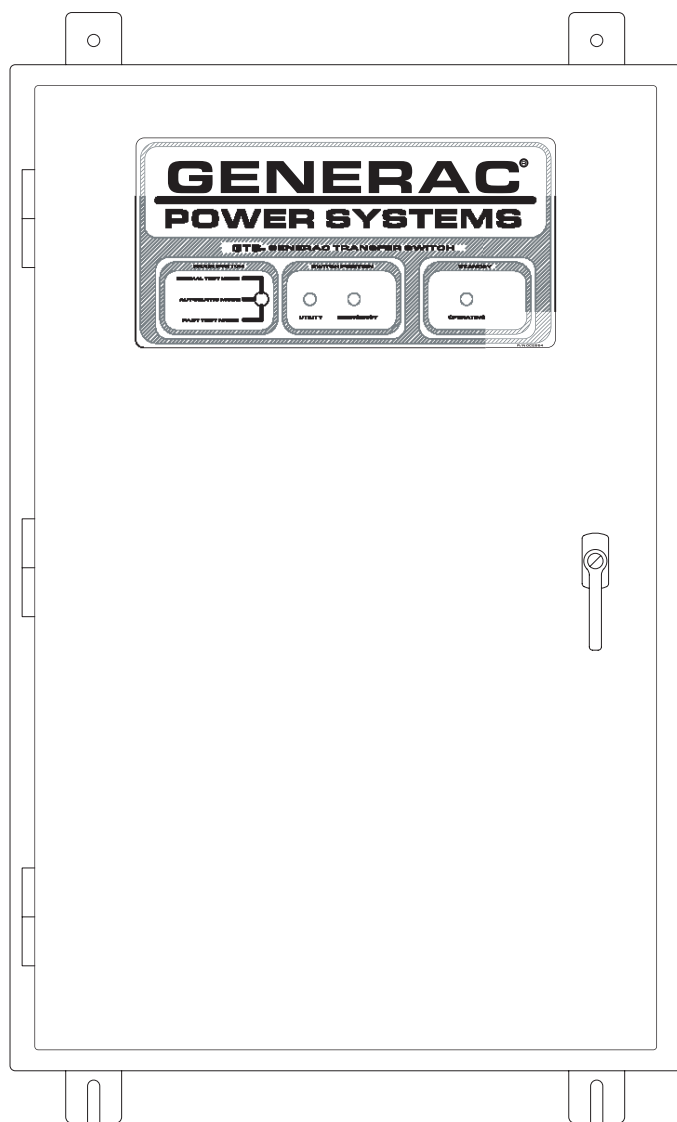

GTS "W" Type

Automatic  
Transfer Switch

100 thru 400 amp,  
600 volts

This manual should remain with the unit.



**⚠** *Read the following information carefully before attempting to install, operate or service this equipment. Also read the instructions and information on tags, decals, and labels that may be affixed to the transfer switch. Replace any decal or label that is no longer legible.* **⚠**

**⚠** **DANGER!** *Connection of a generator to an electrical system normally supplied by an electric utility shall be by means of suitable transfer equipment so as to isolate the electric system from utility distribution system when the generator is operating (Article 701 Legally Required Standby Systems or Article 702 Optional Standby Systems, as applicable). Failure to isolate electric system by these means may result in damage to generator and may result in injury or death to utility workers due to backfeed of electrical energy.* **⚠**

Generac cannot possibly anticipate every possible circumstance that might involve a hazard. The warnings in this manual, and on tags and decals affixed to the unit are, therefore, not all-inclusive. If using a procedure, work method or operating technique Generac does not specifically recommend, ensure that it is safe for others. Also make sure the procedure, work method or operating technique chosen does not render the transfer switch unsafe.

Throughout this publication, and on tags and decals affixed to the generator, DANGER, WARNING, CAUTION and NOTE blocks are used to alert personnel to special instructions about a particular operation that may be hazardous if performed incorrectly or carelessly. Observe them carefully. Their definitions are as follows:



**After this heading, read instructions that, if not strictly complied with, will result in personal injury or property damage.**



**After this heading, read instructions that, if not strictly complied with, may result in personal injury or property damage.**



**After this heading, read instructions that, if not strictly complied with, could result in damage to equipment and/or property.**

**NOTE:**

**After this heading, read explanatory statements that require special emphasis.**

These safety warnings cannot eliminate the hazards that they indicate. Common sense and strict compliance with the special instructions while performing the service are essential to preventing accidents.

Four commonly used safety symbols accompany the DANGER, WARNING and CAUTION blocks. The type of information each indicates follows:

**⚠** This symbol points out important safety information that, if not followed, could endanger personal safety and/or property of others.

**⚠** This symbol points out potential explosion hazard.

**⚠** This symbol points out potential fire hazard.

**⚠** This symbol points out potential electrical shock hazard.

### **⚠ GENERAL HAZARDS ⚠**

- Any AC generator that is used for backup power if a NORMAL (UTILITY) power source failure occurs, must be isolated from the NORMAL (UTILITY) power source by means of an approved transfer switch. Failure to properly isolate the NORMAL and STANDBY power sources from each other may result in injury or death to electric utility workers, due to backfeed of electrical energy.
- Improper or unauthorized installation, operation, service or repair of the equipment is extremely dangerous and may result in death, serious personal injury, or damage to equipment and/or personal property.
- Extremely high and dangerous power voltages are present inside an installed transfer switch. Any contact with high voltage terminals, contacts or wires will result in extremely hazardous, and possibly LETHAL, electric shock. DO NOT WORK ON THE TRANSFER SWITCH UNTIL ALL POWER VOLTAGE SUPPLIES TO THE SWITCH HAVE BEEN POSITIVELY TURNED OFF.
- Competent, qualified personnel should install, operate and service this equipment. Adhere strictly to local, state and national electrical and building codes. When using this equipment, comply with regulations the National Electrical Code (NEC), CSA Standard; C22.1 Canadian Electric Code and Occupational Safety and Health Administration (OSHA) have established.
- Never handle any kind of electrical device while standing in water, while barefoot, or while hands or feet are wet. DANGEROUS ELECTRICAL SHOCK MAY RESULT.

- Because jewelry conducts electricity, wearing it may cause dangerous electrical shock. Remove all jewelry (such as rings, watches, bracelets, etc.) before working on this equipment.
- If work must be done on this equipment while standing on metal or concrete, place insulative mats over a dry wood platform. Work on this equipment only while standing on such insulative mats.
- Never work on this equipment while physically or mentally fatigued.
- Keep the transfer switch enclosure door closed and bolted at all times. Only qualified personnel should be permitted access to the switch interior.
- In case of an accident caused by electric shock, immediately shut down the source of electrical power. If this is not possible, attempt to free the victim from the live conductor but **AVOID DIRECT CONTACT WITH THE VICTIM**. Use a nonconducting implement, such as a rope or board, to free the victim from the live conductor. If the victim is unconscious, apply first aid and get immediate medical help.
- When an automatic transfer switch is installed for a standby generator set, the generator engine may crank and start at any time without warning. To avoid possible injury that might be caused by such sudden start-ups, the system's automatic start circuit must be disabled before working on or around the generator or transfer switch. For that purpose, a **SAFETY DISCONNECT** is provided inside the transfer switch. Always set that switch to its **MANUAL** position before working on the equipment. Then place a "DO NOT OPERATE" tag on the transfer switch and on the generator.

**Safety Rules.....Inside Front Cover**

**Section 1 – General Information.....2**

1.1 Introduction .....2

1.2 Equipment Description.....2

1.3 Transfer Switch Data Plate .....2

1.4 Transfer Switch Enclosure .....2

1.5 Safe Use Of Transfer Switch.....2

**Section 2 – Installation .....3**

2.1 Introduction to Installation.....3

2.2 Unpacking .....3

2.3 Mounting .....3

2.4 Connecting Power Source and Load Lines .....3

2.5 Connecting Start Circuit Wires .....4

2.6 Auxiliary Contacts.....5

2.7 Time Delay Neutral On-Off Switch .....6

2.8 Optional Accessories .....6

**Section 3 – Operation .....6**

3.1 Functional Tests & Adjustments .....6

3.2 Manual Operation.....6

3.3 Voltage Checks .....8

3.4 Electrical Operation .....9

3.5 Transfer Mechanism.....9

3.6 Main Contacts at Normal (Utility) .....9

3.7 Main Contacts at Neutral .....10

3.8 Main Contacts at Standby (Emergency) .....10

3.9 Switches and Advisory Lamps .....10

3.10 Mode Switch.....10

3.11 Standby-Operating LED .....10

3.12 Switch Position LED.....11

3.13 Sequence of Operation .....11

3.14 Sequence of Operation Settings .....12

3.15 Transfer Switch Options.....13

3.16 Sensor and Timer Adjustments -  
Sensing Circuit Board .....15

3.17 Adjustments On Inphase Monitor  
Control Circuit Board.....16

3.18 Calibrating the Inphase Monitor  
Control Circuit Board.....18

3.19 Circuit Board Switch SW1 .....18

3.20 Exercise Timer Display.....19

3.21 Exercise Times .....20

3.22 Pushbuttons .....20

3.23 Programming Examples .....20

3.24 Calibrate Utility Voltage Sensing  
Circuit Board .....21

**Section 4 – Maintenance .....21**

4.1 Operate Transfer Switch.....21

4.2 Clean and Inspect Transfer Switch.....21

4.3 Lubrication.....21

4.4 Main Current Carrying Contacts.....22

4.5 Nine-Volt Battery.....22

**Section 5 – Mounting Dimensions .....23**

**Section 6 – Wiring Diagrams & Electrical  
Schematics .....26**

**Section 7 – Exploded Views & Parts Lists .....46**

**Section 8 – Warranty .....Back Cover**

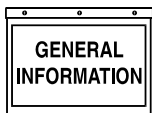

## 1.1 INTRODUCTION

This manual has been prepared especially for the purpose of familiarizing personnel with the design, application, installation, operation and servicing of the applicable equipment. Read the manual carefully and comply with all instructions. This will help to prevent accidents or damage to equipment that might otherwise be caused by carelessness, incorrect application, or improper procedures.

Every effort has been expended to make sure that the contents of this manual are both accurate and current. Generac, however, reserves the right to change, alter or otherwise improve the product at any time without prior notice.

## 1.2 EQUIPMENT DESCRIPTION

The automatic transfer switch is used for transferring critical electrical load from a NORMAL (UTILITY) power source to a STANDBY (EMERGENCY) power source. Such a transfer of electrical loads occurs automatically when the NORMAL power source has failed or is substantially reduced and the STANDBY source voltage and frequency have reached an acceptable level. The transfer switch prevents electrical feedback between two different power sources (such as the NORMAL and STANDBY sources) and, for that reason, codes require it in all standby electric system installations.

The transfer switch consists of a solid state intelligence circuit, a transfer mechanism and a control panel.

## 1.3 TRANSFER SWITCH DATA PLATE

A DATA PLATE is permanently affixed to the transfer switch enclosure. Use this transfer switch only with the specific limits shown on the DATA PLATE and on other decals and labels that may be affixed to the switch. This will prevent damage to equipment and property.

When requesting information or ordering parts for this equipment, make sure to include all information from the DATA PLATE.

Record the Model and Serial numbers in the space provided below for future reference.

MODEL #
SERIAL #

## 1.4 TRANSFER SWITCH ENCLOSURE

The standard switch enclosure is a National Electrical Manufacturer’s Association (NEMA) 1 type. NEMA 1 type enclosures primarily provide protection against contact with the enclosed equipment and against a limited amount of falling dirt. NEMA 1 type enclosures are for indoor use only.

## 1.5 SAFE USE OF TRANSFER SWITCH

Before installing, operating or servicing this equipment, read the SAFETY RULES (inside front cover) carefully. Comply strictly with all SAFETY RULES to prevent accidents and/or damage to the equipment. Generac recommends that a copy of the SAFETY RULES be posted near the transfer switch. Also, be sure to read all instructions and information found on tags, labels and decals affixed to the equipment.

Two publications that outline the safe use of transfer switches are the following:

- NFPA 70; National Electrical Code
- UL 1008, STANDARD FOR SAFETY-AUTOMATIC TRANSFER SWITCHES

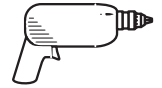

## 2.1 INTRODUCTION TO INSTALLATION

This equipment has been wired and tested at the factory. Installing the switch includes the following procedures:

- Mounting the enclosure.
- Connecting power source and load leads.
- Connecting the generator start circuit.
- Connecting any auxiliary contact (if needed)
- Installing/connecting any options and accessories.
- Testing functions.

## 2.2 UNPACKING

Carefully unpack the transfer switch. Inspect closely for any damage that might have occurred during shipment. The purchaser must file with the carrier any claims for loss or damage incurred while in transit.

Check that all packing material is completely removed from the switch prior to installation.

Attach any lifting device to the transfer switch mounting holes or brackets only. **DO NOT LIFT THE SWITCH AT ANY OTHER POINT.**

## 2.3 MOUNTING

Mounting dimensions for the transfer switch enclosure are in this manual. Enclosures are typically wall-mounted. Components are generally mounted in a standard NEMA 1-type enclosure. A NEMA 12, 3R, 4 & 4X are also available. See TRANSFER SWITCH OPTIONS, Section 3.15.



CAUTION

- ▲ Handle transfer switches carefully when installing. Do not drop the switch. Protect the switch against impact at all times, and against construction grit and metal chips. Never install a transfer switch that has been damaged.

Install the transfer switch as close as possible to the electrical loads that are to be connected to it. Mount the switch vertically to a rigid supporting structure. To prevent switch distortion, level all mounting points. If necessary, use washers behind mounting holes to level the unit.

## 2.4 CONNECTING POWER SOURCE AND LOAD LINES



DANGER

- ▲ Make sure to turn OFF both the NORMAL (UTILITY) and STANDBY (EMERGENCY) power supplies before trying to connect power source and load lines to the transfer switch. Supply voltages are extremely high and dangerous. Contact with such high voltage power supply lines causes extremely hazardous, possibly lethal, electrical shock.

Wiring diagrams and electrical schematics are provided in this manual. Power source and load connections are made at a transfer mechanism, inside the switch enclosure.

### ◆ 2.4.1 2-POLE MECHANISM

This switch (Figure 2.1) is used with a single-phase system, when the single-phase NEUTRAL line is to be connected to a Neutral Lug and is not to be switched.

Figure 2.1 — Typical 2-Pole Transfer Mechanism (100 Amp Shown)

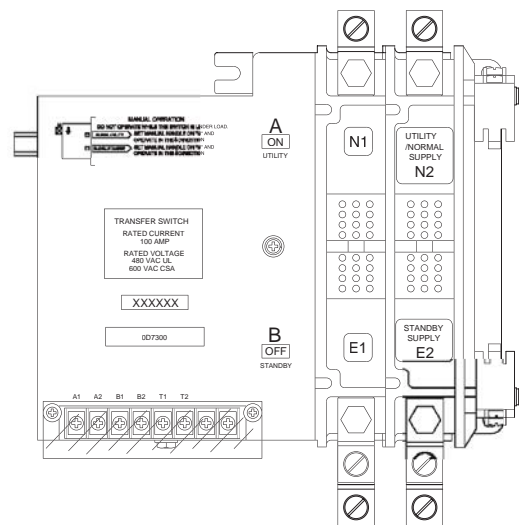

### ◆ 2.4.2 3-POLE MECHANISM

This switch (Figure 2.2) is used with a single-phase system, when the single-phase NEUTRAL line is to be switched during transfer; or with a three-phase system, when NEUTRAL is not to be switched.

Figure 2.2 — Typical 3-Pole Transfer Mechanism (200 Amp Shown)

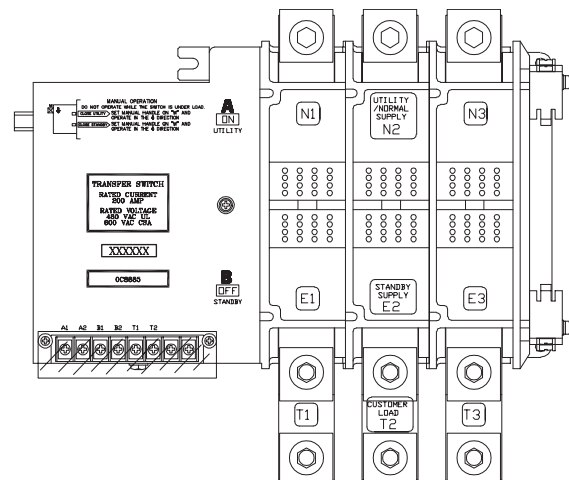

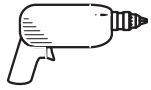

**◆ 2.4.3 4-POLE MECHANISM**

This switch (Figure 2.3) is used with a three-phase system, when the NEUTRAL line is to be switched during transfer action.

**Figure 2.3 — Typical 4-Pole Transfer Mechanism (400 Amp Shown)**

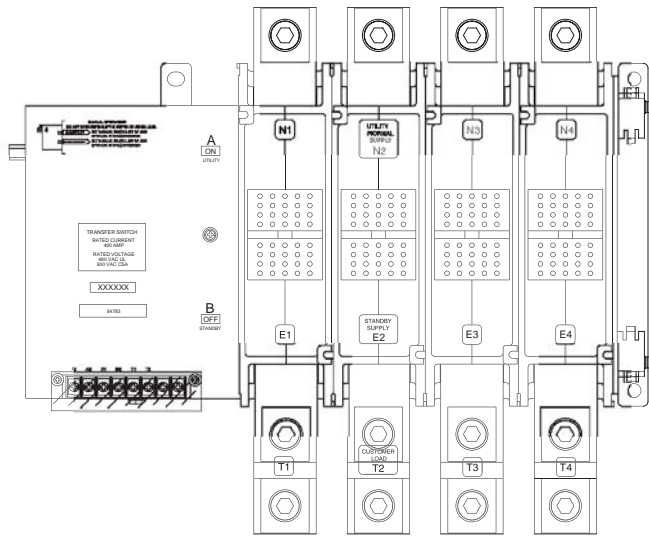

**⚠ DANGER ⚠**



**All power voltage supplies must be turned off before attempting to connect power source and load lines. Failure to turn off power voltage supplies will result in extremely dangerous and possibly lethal electrical shock.**

All power cables should enter the switch next to the transfer mechanism terminals. Standard terminal lugs on the transfer mechanism are solderless, screwtype.

Connect power source and load conductors to clearly marked terminal lugs on transfer mechanism as follows:

- LOAD leads: Connect to terminals T1, T2, T3, & T4\*.
- NORMAL (UTILITY) Source Leads: To terminals N1, N2, N3, & N4\*.
- STANDBY (EMERGENCY) Source Leads: Connect to transfer mechanism terminal lugs E1, E2, E3, & E4\*.

\* The connection diagram (Figure 2.4) shows a typical three-phase installation without switched neutral. T4, N4, and E4 are not used.

**NOTE:**

**Unless otherwise specified, a NEUTRAL block is not supplied with transfer switch on single-phase, 3-pole units where the NEUTRAL line is to be switched during transfer action. Similarly, a NEUTRAL block is not supplied on three-phase, 4-pole units where the NEUTRAL line is to be switched during transfer.**

Solderless, screw-type terminal lugs are standard. Conductor sizes must be adequate to handle the maximum current to which they will be subjected to, based on the 75°C column of tables, charts, etc. used to size conductors. The installation must comply fully with all applicable codes, standards and regulations.

Before connecting wiring cables to terminals, remove any surface oxides from the cable ends with a wire brush. If ALUMINUM conductors are used, apply corrosion inhibitor to conductors. After tightening terminal lugs, carefully wipe away any excess corrosion inhibitor.

Tighten terminal lugs to the torque values as noted inside the transfer switch door.

**⚠ CAUTION ⚠**



**Use a torque wrench to tighten the conductors, being sure not to overtighten, or damage to the switch base could occur. If not tightened enough, a loose connection would result, causing excess heat which could damage the switch base.**

Switch Rating	Wire Range
100A	#6-2/0 AWG
150-200A	#4-400 MCM
300-400A	(1) #4-600 MCM or (2) 1/0-250 MCM

Be sure to maintain proper electrical clearance between live metal parts and grounded metal. Allow at least 1/2 inch for 100-400 amp circuits and at least one inch for circuits over 400 amps.

**2.5 CONNECTING START CIRCUIT WIRES**

Connect suitable, approved wiring to transfer switch terminals 178 and 183 (see chart). Route these wires through suitable, approved conduit (separate from AC power leads) and connect to identically numbered terminals in the AC connection (lower) panel of Generac power systems (engine-generator set). See Figure 2.4.

Closure of Wire 178/183 circuit by switch circuit action must result in generator engine cranking and startup.

**NOTE:**

**The preceding applies to the standard TWO-WIRE START SYSTEM. If a generator having a THREE-WIRE START SYSTEM is to be installed, using the optional three-wire start system. See TRANSFER SWITCH OPTIONS, Section 3.15.**



Figure 2.4 — Connection Diagram - Three-phase With Neutral Shown (Typical)

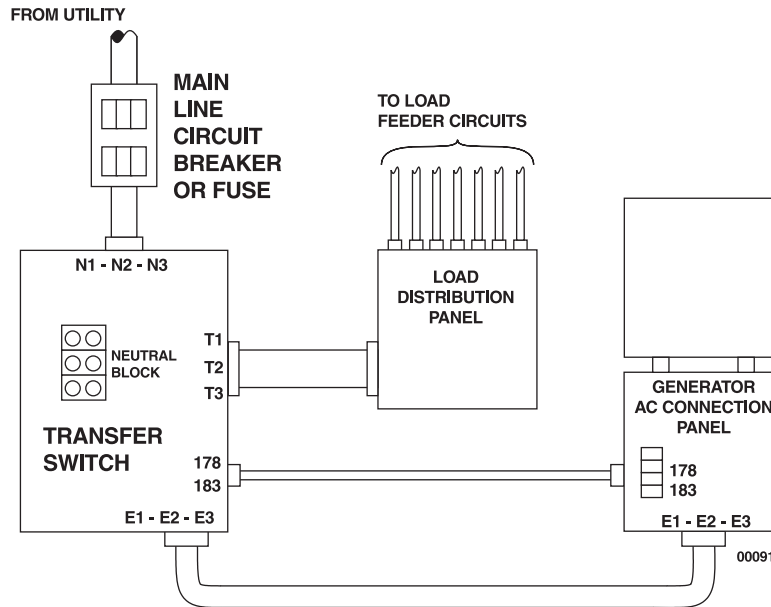

Recommended wire gauge sizes for this wiring depends on the length of the wire, as recommended below:

MAXIMUM WIRE LENGTH	RECOMMENDED WIRE SIZE
460 feet (140m)	No. 18 AWG.
461 to 730 feet (223m)	No. 16 AWG.
731 to 1,160 feet (354m)	No. 14 AWG.
1,161 to 1,850 feet (565m)	No. 12 AWG.

## 2.6 AUXILIARY CONTACTS

There is access to Auxiliary Contacts on the transfer switch to operate customer accessories, remote advisory lights, or remote annunciator devices. A suitable power source must be connected to the COMMON (C) terminal. The contacts shown as FACTORY in Figure 2.5 are connected at the factory for operating transfer switch advisory lights. The contacts shown as auxiliary are available for customer use.

Figure 2.5 — Auxiliary Contact Diagram

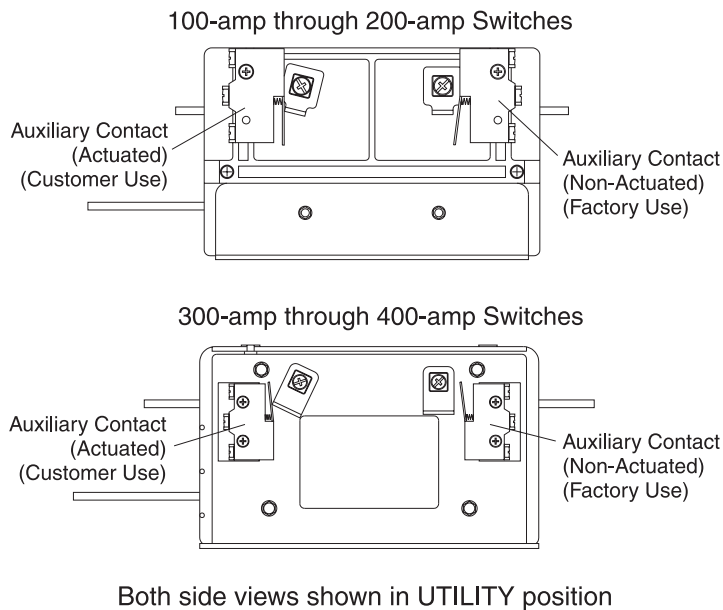

Both side views shown in UTILITY position

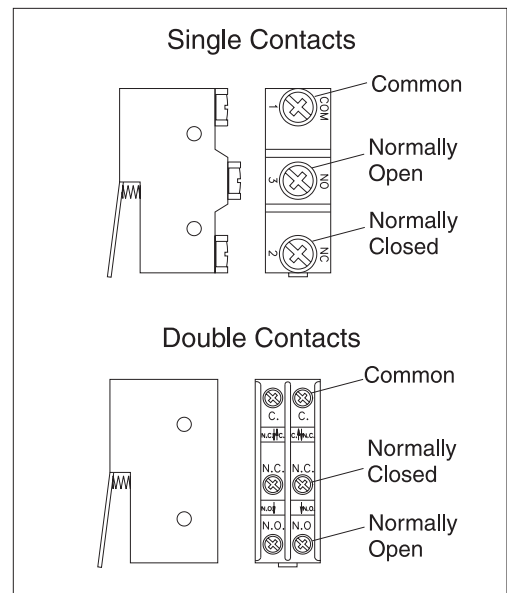

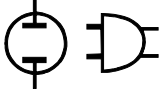

Contact operation is shown in the following chart:

	Switch Position	
	Utility	Standby
Common to Normally Open	Closed	Open
Common to Normally Closed	Open	Closed

**NOTE:**

**Auxiliary Contacts are rated 10 amps at 125 or 250 volts AC. DO NOT EXCEED THE RATED VOLTAGE AND CURRENT OF THE CONTACTS.**

### 2.7 TIME DELAY NEUTRAL ON-OFF SWITCH

The Time Delay Neutral feature extends the time that the main contacts normally disconnect. By permitting the LOAD to remain disconnected from both power sources for a fixed time setting, residual voltages generated by heavy inductive loads will decay to a safe level before reconnecting. This provides some protection against nuisances such as blown fuses or circuit breakers that otherwise might occur during a rapid transfer of motor and other heavy inductive loads.

Units with the Time Delay Neutral feature are equipped with a Time Delay On/Off switch. To eliminate the time delay at neutral during a transfer action, set the switch to OFF.

Figure 2.6 — Time Delay Neutral Switch

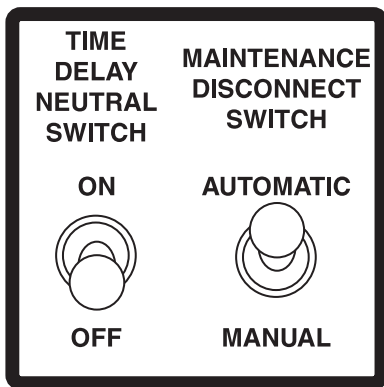

### 2.8 OPTIONAL ACCESSORIES

Note any optional accessories that may be installed on the transfer switch or are to be installed in the standby electric system in conjunction with the switch. Complete the necessary connections for these accessories.

### 3.1 FUNCTIONAL TESTS AND ADJUSTMENTS

Following transfer switch installation and interconnection, inspect the entire installation carefully. A competent, qualified electrician should inspect it. The installation should comply strictly with all applicable codes, standards, and regulations. When absolutely certain the installation is proper and correct, complete a functional test of the system. Perform functional tests in the exact order presented in this manual, or the switch could be damaged.

**IMPORTANT:** Before proceeding with functional tests, read and make sure all instructions and information in this section are understood. Also read the information and instructions of labels and decals affixed to the switch. Note any options or accessories that might be installed and review their operation.

### 3.2 MANUAL OPERATION



**Do NOT manually transfer under load. Disconnect transfer switch from all power sources by approved means, such as a main circuit breaker(s).**

A manual HANDLE is shipped with the transfer switch. Manual operation must be checked BEFORE the transfer switch is operated electrically. To check manual operation, proceed as follows:

1. In the transfer switch enclosure, set the Maintenance Disconnect switch to MANUAL. This prevents the generator from starting automatically as soon as the UTILITY power source is turn OFF .
2. If so equipped, turn the generator’s AUTO-OFF-MANUAL switch to OFF.
3. Turn OFF both NORMAL and STANDBY power supplies to the transfer switch, with whatever means provided (such as the main line circuit breaker(s)).
4. Note position of transfer mechanism main contacts by observing display windows in “A” and “B” in Figure 3.1 as follows:
  - Window “A” ON, Window “B” OFF - LOAD terminals (T1, T2, T3) are connected to NORMAL terminals (N1, N2, N3).
  - Window “A” OFF, Window “B” ON - LOAD terminals (T1, T2, T3) are connected to STANDBY terminals (E1, E2, E3).



**Do not use excessive force when operating the transfer switch manually or the manual handle could be damaged.**

◆ **3.2.1 CLOSE TO NORMAL SOURCE SIDE**

Before proceeding, verify the position of the switch by observing window “A” in figure 3.1. If window “A” reads “ON”, proceed with Step 1, and if it reads “OFF”, proceed with Step 2.

Step 1: With the handle attached to the actuating shaft, move handle in the direction of the arrow on the switch cover until it stops — DO NOT FORCE. Release handle slowly to allow the spring in the switch box to relax. “OFF” now appears in Window “A” and “ON” appears in Window “B”. (Proceed with Step 2).

Step 2: With the handle attached to the actuating shaft, move handle in the direction of the arrow on the switch cover until it stops — DO NOT FORCE. Release handle slowly to allow the spring in the switch box to relax. “ON” now appears in Window “A” and “OFF” appears in Window “B”. (Proceed with B: Close to STANDBY Source Side).

◆ **3.2.2 CLOSE TO STANDBY SOURCE SIDE**

Before proceeding, ensure that the previous 3.2.1, “Step 2” Close to NORMAL Source Side is completed. See Figure 3.1. This will ensure that Window “B” on the switch reads “OFF”. With the handle attached to the actuating shaft, move the handle in the direction of the arrow on the switch cover until it stops - DO NOT FORCE. Release handle slowly to allow the spring in the switch box to relax. “OFF” now appears in Window “A” and “ON” appears in Window “B”.

◆ **3.2.3 RETURN TO NORMAL SOURCE SIDE**

Manually actuate switch to return Window “A” to the “ON” position.

Figure 3.1 — Actuating Transfer Switch



**DANGER: Do NOT manually transfer under load. Disconnect transfer switch from all power sources by approved means, such as a main circuit breaker(s).**

Detail of instructions printed on transfer switch

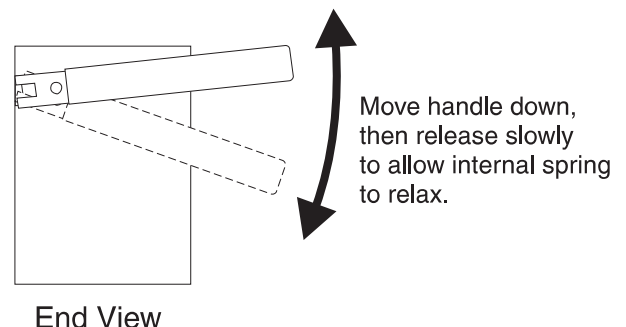
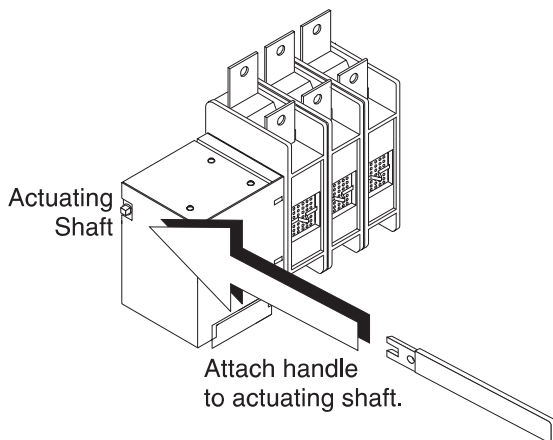
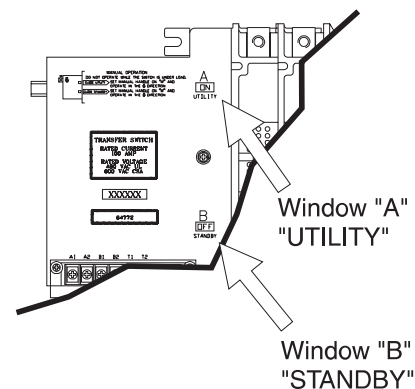
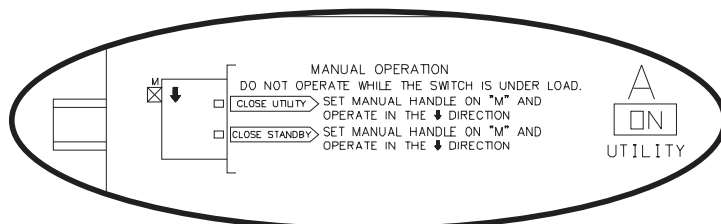

NOTE: Return handle to storage position in enclosure when finished with manual transfer

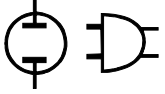

### 3.3 VOLTAGE CHECKS



**DANGER**

 Disconnect all loads from the transfer switch until all voltage checks and phase rotation checks have been completed to prevent possible injury to personnel and, or damage to equipment.

 For safety, set the maintenance disconnect switch (inside transfer switch enclosure) to its **MANUAL** position before proceeding with voltage checks.

 Before proceeding, check the transfer switch data **PLATE** for switch rated voltage. Make sure the data plate voltage is compatible with **NORMAL** and **STANDBY** power source voltages.

 Proceed with caution. Do not touch electrically hot terminals, wires, etc. During the voltage checks, the transfer switch is electrically energized.

Perform voltage checks as follows:

1. Inside the transfer switch enclosure, set the Maintenance Disconnect switch to **MANUAL**.
2. If generator is so equipped, set the **AUTO-OFF-MANUAL** switch to **OFF**.
3. On the switch enclosure door, set **SYSTEM TEST** switch to **AUTOMATIC MODE** position.
4. Check that the word “**ON**” is visible in Window “**A**”, the word “**OFF**” in Window “**B**”. See **MANUAL OPERATION** for location of “**A**” and “**B**” windows.

**IMPORTANT: DO NOT PROCEED UNTIL STEPS 1, 2, 3, AND 4 HAVE BEEN COMPLETED.**



**CAUTION**

 Before proceeding to voltage checks, manually connect the load to **NORMAL** power supply. window “**A**” must indicate **ON**, Window “**B**” must indicate **OFF** before proceeding.

5. Turn **ON** the **NORMAL (UTILITY)** power supply to the transfer switch, with whatever means provided (such as the main line circuit breaker).



**DANGER**

 The transfer switch is now electrically hot. Proceed with caution.

6. With **UTILITY** voltage available to the transfer switch, check that the **SWITCH - POSITION UTILITY LED** on the enclosure door is **ON**. If the **SWITCH - POSITION UTILITY LED** is **OFF**, turn off the utility power supply to the transfer switch by whatever means provided (such as the main line circuit breaker), then proceed back to Step 1 of “**VOLTAGE CHECKS**”.
7. Inside the transfer switch enclosure door, locate the Utility Voltage Sensor Circuit Board. The **UTILITY ON LED** should be **ON**.

8. With an accurate AC voltmeter, check the phase-to-phase (line-to-line) and phase-to-neutral (line-to-neutral) voltages present at transfer mechanism terminals **N1**, **N2**, **N3** and neutral. **SUPPLIED VOLTAGES MUST BE FULLY COMPATIBLE WITH TRANSFER SWITCH RATED VOLTAGE.**



**DANGER**

 Ensure that the phase rotation of **NORMAL (UTILITY)** power lines and transfer switch load power lines are compatible.

9. Refer to the standby generator instruction manual. Make sure the generator engine has been properly serviced and prepared for use, as outlined in that manual. Then start the generator engine manually. Let the engine stabilize and warm up for a few minutes.
10. Turn **ON** the **STANDBY (EMERGENCY)** power supply to the transfer switch by whatever means provided (such as the main line circuit breaker).
11. With the generator running, check that the **STANDBY - OPERATING LED** on the switch enclosure door is **ON**.
12. With an accurate AC voltmeter, check phase-to-phase (line-to-line) and phase-to neutral (line-to-neutral) voltages present at transfer mechanism terminals **E1**, **E2** and **E3**. Also check AC frequency at those terminals. Generator AC output voltage and frequency must be compatible with transfer switch rated voltage and frequency.



**DANGER**

 Ensure that the phase rotation of **STANDBY (GENERATOR)** power lines and transfer switch **NORMAL (UTILITY)** and load power lines are compatible.

13. If supplied voltage or frequency is incorrect, refer to standby generator Owner’s Manual. If AC frequency is incorrect, adjust engine governed speed. If voltage is incorrect, adjust generator’s voltage regulator or correct the problem.
14. When supplied voltage and frequency is correct, shut down the engine manually.



**DANGER**

 Supplied voltages from both **NORMAL (UTILITY)** and **STANDBY (EMERGENCY)** power sources must be compatible with transfer switch rated voltage before proceeding.

15. Connect the transfer switch load to the transfer switch when “voltage checks” section has been completed. Connect the load to the transfer switch by whatever means provided (such as circuit breaker(s)), then proceed with the “**ELECTRICAL OPERATION**” section.

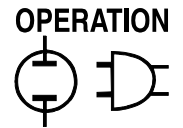

### 3.4 ELECTRICAL OPERATION

Test transfer system electrical operation as follows:

1. On the Utility Voltage Sensor circuit board, check that the UTILITY ON LED is ON. If not, refer to Section 3.24 for calibration procedures.
2. On the enclosure door, check that the SWITCH POSITION-UTILITY LED is ON.



**CAUTION**  
The UTILITY ON lamp (on circuit board) and the SWITCH POSITION-UTILITY LED (on enclosure door) must both be ON before proceeding to Step 3.

3. Refer to the appropriate owner’s manual. Be sure the standby generator is prepared for automatic operation.
4. In the switch enclosure, set the Maintenance Disconnect switch to AUTOMATIC.
5. Set the Mode Switch to its NORMAL TEST MODE position. Generator startup and transfer to the STANDBY power source should occur. Refer to the SEQUENCE OF OPERATION, Section 3.13.

**NOTE:**

All systems are equipped with the Inphase Monitor Control board, and advisory lights on the circuit board will light up to indicate operation of the various solid state timers that control automatic operation. By observing these LED’s, the operator can check the automatic operating sequences and times. See SENSOR AND TIMER ADJUSTMENTS, Section 3.16. For a detailed description of the automatic operating sequences, see SEQUENCE OF OPERATION, Section 3.13.

6. When the test is complete, return the Mode Switch to its AUTOMATIC MODE position. Retransfer back to the UTILITY (NORMAL) power source. The generator should shut down according to circuit board timers.

### 3.5 TRANSFER MECHANISM

- The transfer mechanism houses the main, current carrying contacts, along with other mechanical and electrical components required for operating the switch (Figure 3.2). Main contacts are actuated by a single solenoid, are electrically operated and mechanically held. Power for that coil’s operation is taken from the side to which the LOAD is being transferred. Therefore, transfer to any power source cannot occur unless that power source is available to the switch.

- LOAD or “T” contacts, bolted to an insulated plastic pole piece are stationary. The NORMAL (UTILITY) and STANDBY (EMERGENCY) contacts are moveable. The contacts are actuated by means of a closing coil and mechanical linkage. The pole assemblies which retain the stationary moveable main contacts are assembled together and retained by through-bolts. Either 2, 3 or 4-pole assemblies may be used to form a 2, 3 or 4-pole mechanism.

Figure 3.2 — The Transfer Mechanism

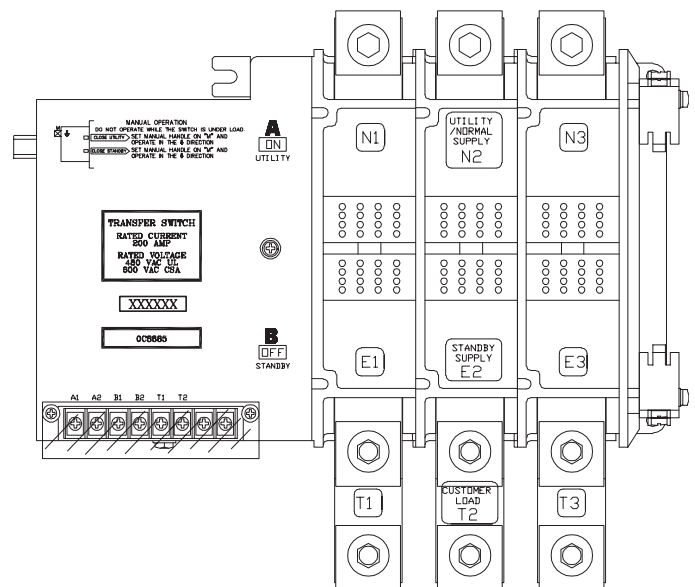

### 3.6 MAIN CONTACTS AT NORMAL (UTILITY)

The illustration shows the LOAD terminals connected to the NORMAL (UTILITY) terminals. Window “A” displays the word “ON” and window “B” the word “OFF” (Figure 3.3).

Figure 3.3 — Main Contact at Normal (Utility)

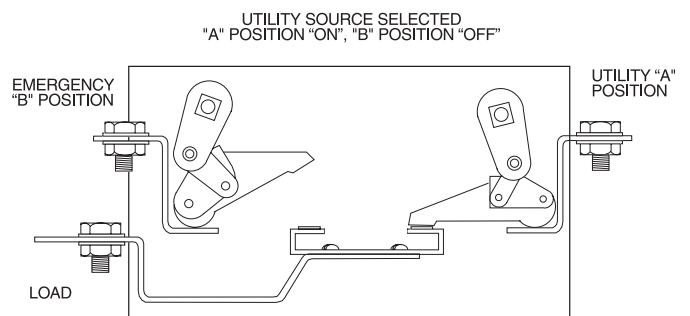

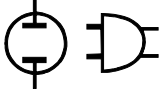

### 3.7 MAIN CONTACTS AT NEUTRAL

LOAD terminals are disconnected from both power supply terminals. The word “OFF” is displayed in both Windows “A” and “B” (Figure 3.4).

Figure 3.4 — Main Contacts at Neutral

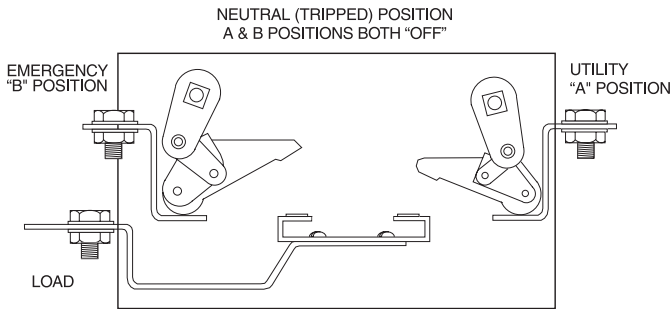

### 3.8 MAIN CONTACTS AT STANDBY (EMERGENCY)

LOAD terminals are connected to the STANDBY (EMERGENCY) power supply. Window “B” displays the word “ON” and window “A” the word “OFF” (Figure 3.5).

Figure 3.5 — Main Contacts at Standby (Emergency)

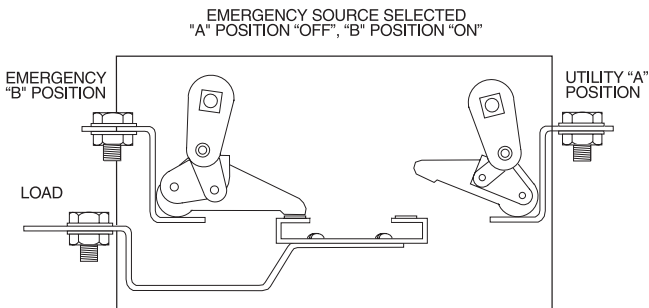

### 3.9 SWITCHES AND ADVISORY LAMPS

This section will familiarize personnel with switches and advisory lights on the transfer switch enclosure door, as well as with the Safety Disconnect Switch inside the switch enclosure.

Circuit board inside the switch door may also mount several switches. Operation of these switches will be covered in the section entitled SENSOR AND TIMER ADJUSTMENTS.

### 3.10 MODE SWITCH

This switch allows operator selection of AUTOMATIC, NORMAL TEST or FAST TEST mode as follows (Figure 3.6):

#### ◆ 3.10.1 AUTOMATIC MODE

Use this switch position for all normal automatic operations. With AUTOMATIC MODE selected, any NORMAL source voltage that dropped below a pre-set value will result in the automatic sequence of events listed in the chart in Section 3.14.

#### ◆ 3.10.2 NORMAL TEST MODE

Allows the operator to test automatic operations, just as though an actual drop in NORMAL source voltage had occurred. See the chart in Section 3.14. During the test, observe the LED’s on the transfer switch circuit board to monitor automatic operating sequences.

#### ◆ 3.10.3 FAST TEST MODE

Allows the operator to test system operation with all circuit board timers accelerated to less than five seconds. Switch is spring-loaded back to AUTOMATIC MODE, so continuously hold the FAST TEST CONTROL. Following the generator startup, loads are transferred to the EMERGENCY (STANDBY) power source as soon as EMERGENCY source voltage and frequency have reached the settings of STANDBY VOLTAGE and STANDBY FREQUENCY sensors on the SYSTEM CONTROL board.

Figure 3.6 — System Test Switch, Standby Operating LED, and Switch Position LED

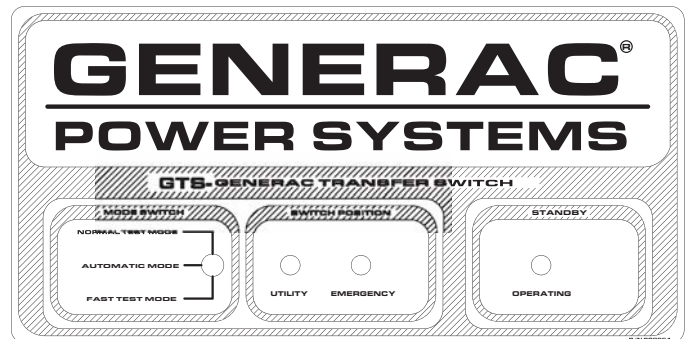

### 3.11 STANDBY-OPERATING LED

This LED goes ON to tell the operator that the standby generator is running and that STANDBY (EMERGENCY) source power is available to the transfer switch.

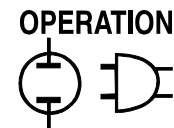

## 3.12 SWITCH POSITION LED

### ◆ 3.12.1 EMERGENCY

This LED goes ON when main current-carrying contacts have actuated to their STANDBY (EMERGENCY) position and that power source is available to the transfer switch.

### ◆ 3.12.2 UTILITY

This LED goes ON when main contacts have actuated to NORMAL (UTILITY) position and that power supply is available to the transfer switch.

The switch is equipped with the Inphase Monitor Control circuit board. The sensors and timers are adjustable (see SENSOR AND TIMER ADJUSTMENTS).

## 3.13 SEQUENCE OF OPERATION

When acceptable NORMAL source voltage is available, observe the following:

- Utility Voltage Sensor circuit board monitor's NORMAL source voltage and UTILITY ON LED is ON.
- Switch Position - UTILITY LED is ON.
- Transformer reduced LOAD (T) terminal voltage is delivered to the 7-day exerciser board to operate the 7-day exercise timer.

Monitor automatic timers and sensors on the Inphase Monitor Control circuit board, by observing the LED's next to the sensor/timer adjustments.

### ◆ 3.13.1 SEQUENCE 1 - VOLTAGE DROPOUT

- UTILITY source voltage drops below 75-95% of the Voltage Pickup Setting. The UTILITY ON LED goes OFF.
- Voltage Dropout sensor is factory set to about 90% of "pickup" voltage.
- Voltage dropout below this sensor's setting triggers Sequence 2.

### ◆ 3.13.2 SEQUENCE 2 - LINE INTERRUPT DELAY

- UTILITY voltage dropout below setting of Voltage Dropout sensor turns on a Line Interrupt Delay Timer.
- Line Interrupt Delay may be set for 0.1 to 10 seconds. Factory set to about five seconds.
- If voltage dropout lasts longer than Line Interrupt Delay setting, circuit board action closes the automatic start circuit (Wires 178 and 183). When that circuit closes, engine cranks and starts as controlled by a circuit board in the generator's control panel.
- Once the standby generator starts and produces voltage, the circuit board is turned ON (go to Sequence 3).

### ◆ 3.13.3 SEQUENCE 3 - ENGINE MINIMUM RUN AND WARMUP TIMERS

- This timer establishes the minimum length of time for the generator to run before it can be shut down. Timer prevents shutdown of a cold engine.
- Timer is adjustable from five to 30 minutes. Factory setting is about 20 minutes.
- An engine warmup timer is also turned ON. This timer permits engine to stabilize and warm up before loads are transferred to STANDBY. Timer is adjustable from five seconds to three minutes. Factory setting is about one minute.

### ◆ 3.13.4 SEQUENCE 4 - STANDBY VOLTAGE AND FREQUENCY SENSORS

- If generator AC output voltage and frequency is above the setting of these sensors, loads transfer to the STANDBY power source.
- Adjust Standby Voltage Sensor between 85% and 95% of nominal supply voltage. Factory setting is about 95%.
- Adjust Standby Frequency Sensor between 80% and 90% or nominal supply frequency. Factory setting is about 90%.

#### NOTE:

**Bypass the engine warmup timers by setting the Engine Warmup Timer Bypass switch to ON. Loads are transferred to STANDBY as soon as generator AC voltage and frequency have reached the settings of the Voltage and Frequency sensors without having to wait for the engine to warm up.**

### ◆ 3.13.5 SEQUENCE 5 - VOLTAGE PICKUP

- If the UTILITY source voltage is restored above the setting of the Voltage Pickup sensor, Sequence 5 begins.
- Adjust Voltage Pickup between 85% to 95% of the normal supply voltage from the UTILITY source. Factory setting is about 90%.

### ◆ 3.13.6 SEQUENCE 6 - RETURN TO UTILITY TIMER

- This timer prevents re-transfer that a Utility Source voltage surge or transient might cause.
- Adjust timer between one to 30 minutes. Factory setting is about five minutes.
- If UTILITY voltage remains above the setting of the Voltage Pickup Sensor for the time interval of the Return to Utility Timer setting, loads are re-transferred back to the UTILITY source.

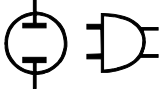

◆ 3.13.7 SEQUENCE 7 - ENGINE COOL DOWN TIMER

NOTE:

- After the switch re-transfers loads back to UTILITY, this timer starts. When the interval has expired, the automatic start circuit (Wires 178/183) is opened, and the engine shuts down.
- Timer allows engine to run at no-load for a fixed time, so the engine internal temperature can stabilize before shutting down.
- Set the timer for one to 30 minutes. Factory setting is about 10 minutes.

**Actual time between re-transfer back to UTILITY and engine shutdown is whichever is longer of the Engine Cool Down timer setting or any time remaining on Engine Minimum run timer.**

After the switch automatically re-transferred loads back to the UTILITY power source and generator has shut down, the system is “armed” for Sequence 1 again.

3.14 SEQUENCE OF OPERATION SETTINGS

*Units with Inphase Monitor Control Circuit Board*

SEQUENCE	ACTION	TIMER/SENSOR	ADJUST RANGE	FACTORY SETTING
—*	UTILITY volts available - no action	Voltage Dropout Sensor	75 - 95%	90%
A*	UTILITY voltage drops out	Voltage Dropout Sensor	75 - 95%	90%
B	Line Interrupt Delay Timer Starts	Line Interrupt Delay Timer	0.1 - 10 seconds	5 seconds
C	Line Interrupt Delay Timer Stops	Line Interrupt Delay Timer	.01 - 10 seconds	5 seconds
—	Engine cranks and starts			
D	Engine Minimum Run Timer starts	Engine Minimum Run Timer	5 to 30 minutes	20 minutes
E**	Engine Warmup Timer Starts	Engine Warmup Timer	5 sec. - 3 min.	1 minute
F	STANDBY ON lamp ON			
G**	Engine Warmup Timer stops	Engine Warmup Timer	5 sec. - 3 min.	1 minute
H	Is STANDBY voltage good?	Standby Voltage Sensor	85 - 95%	90%
J	Is STANDBY frequency good?	Standby Frequency Sensor	80 - 90%	90%
K	Time Delay at NEUTRAL	Time Delay Neutral Timer	0.1 - 10 seconds	5 seconds
L	Inphase Transfer	Inphase Transfer Select	None	
—	Transfer to STANDBY			
M	TRANSFER TO STANDBY lamp ON			
—	STANDBY source powers LOAD			
N	UTILITY voltage restored	Voltage Pickup Sensor	85 - 95%	90%
O	Return to UTILITY Timer ON	Return to Utility Timer	1 - 30 minutes	5 minutes
P	Timed Delay at NEUTRAL	Time Delay Neutral Timer	0.1 - 10 seconds	5 seconds
R	Inphase Transfer	Inphase Transfer Select	none	0.1 - 30 seconds
S	Signal Before Transfer LED lights	Signal Before Transfer Timer	1 - 30 seconds	10 seconds
—	Re-transfer to UTILITY source			
T***	Engine Cooldown Timer starts	Engine Cooldown Timer	1 - 30 minutes	10 minutes
U***	Engine Cooldown Timer stops	Engine Cooldown Timer	1 - 30 minutes	10 minutes
—	Engine shuts down			
—	UTILITY volts available - no action			

\* 75 - 95% of the Voltage Pickup Sensor setting

\*\* Engine Warmup Timer can be bypassed. See SENSOR AND TIMER ADJUSTMENTS

\*\*\* Following re-transfer to UTILITY source, engine shutdown will not occur until both Engine Minimum run and Engine Cooldown timers have expired.

### 3.15 TRANSFER SWITCH OPTIONS

The transfer switch may be equipped with one or more of the following options:

- Instrument Package, 3.15.1
- Signal Before Transfer, 3.15.2
- Remote Auto Control, 3.15.3
- Manual bypass for return to Normal, 3.15.4
- Preferred Source Selector, 3.15.5
- Manual Three-position Selector Switch (Normal-Auto-Standby) 3.15.6
- NEMA 3R, 4, 4X or 12 enclosure, 3.15.7 through 3.15.10

#### ◆ 3.15.1 INSTRUMENT PACKAGE

The optional instrument package includes: (a) an AC voltmeter, (b) an AC ammeter, (c) an AC frequency meter, (d) an hourmeter, and (e) a phase-selector switch (Figure 3.7). Several current transformers are required to operate the instrument package, i.e., two for single-phase systems, three for three-phase systems. Use the phase selector switch to select the single-phase voltage and current being read as follows:

SWITCH OPERATION	CURRENT READING	VOLTAGE READING
1	Line 1	Line 1 to Neutral
2	Line 2	Line 2 to Neutral
3	No reading	Line 1 to Line 2
OFF	No reading	No reading

For three-phase systems use the switch as follows:

SWITCH OPERATION	CURRENT READING	VOLTAGE READING
1	Phase A	Phase A to Phase B
2	Phase B	Phase B to Phase C
3	Phase C	Phase C to Phase A
OFF	No reading	No reading

Figure 3.7 — Instrument Package

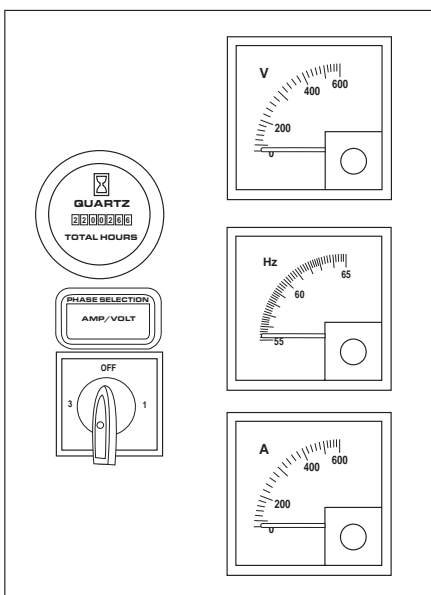

#### ◆ 3.15.2 SIGNAL BEFORE TRANSFER

The Signal Before Transfer option includes a signal relay, customer connection terminal strip and the associated wiring. See Figure 3.8.

The logic for this option is a part of the GTS Controller PCB. The option is active when the Signal Before Transfer switch is ON. The delay time is adjustable from one to 30 seconds.

The basic operation of the option is to delay (for the period of time set on timer) the transfer of the GTS mechanism while a signal relay (SR) is energized. When the relay is energized, two sets of the dry contacts (wires 236 and 240, and 237 and 238) are closed. These dry contacts can be connected to, via a terminal strip located on the bottom of the subplate. Reference wiring diagram 0D8035 for further details. The customer connections are made on terminal strip TS4.

Figure 3.8 — Signal Before Transfer

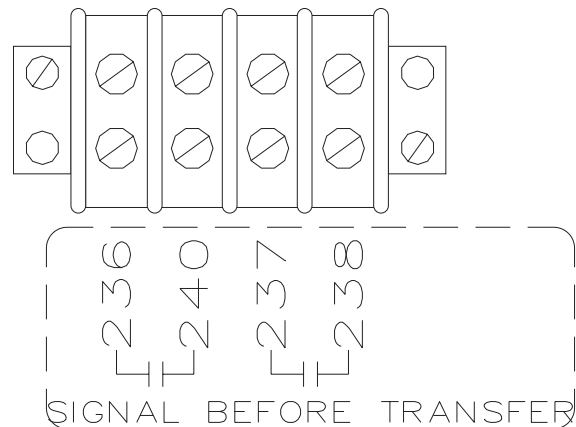

**NOTE:**

**This delay is not active on a Normal source failure. Transfer during Normal source failure is immediate.**

**NOTE:**

**The “Signal Before Transfer” feature provides a time delay that allows elevators to continue operating before transfer to another power supply occurs.**

#### ◆ 3.15.3 REMOTE AUTO CONTROL

The Remote Auto Control option includes a customer connection terminal strip and the associated wiring (Figure 3.9 on page 14).

This option allows for remote starting of the generator and transfer of the GTS to connect the LOAD to the EMERGENCY source. This is done by paralleling the Fast Test switch. A description of the Fast Test Mode function can be found in Section 3.10.3.

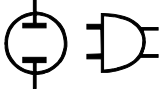

Reference wiring diagram OD8035 for further details. The customer connections are made on TS3. The associated wire numbers are 0, 177, 178 and 201.

Figure 3.9 — Remote Auto Control

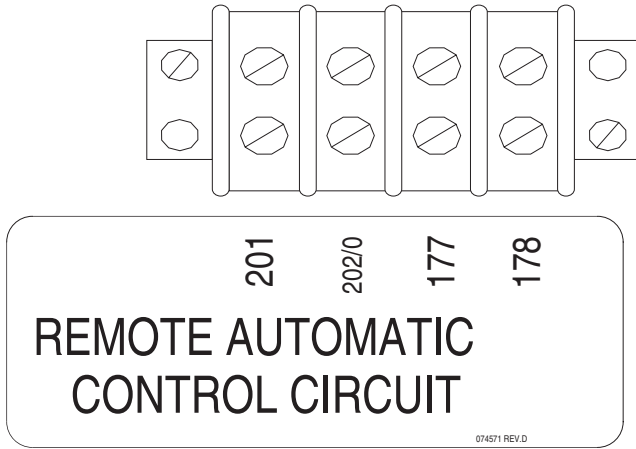

◆ 3.15.4 MANUAL BYPASS FOR RETURN TO NORMAL

The Manual Bypass for Return to Normal option includes a door mounted toggle switch and associated wiring (Figure 3.10).

This option will override the Return to Utility timer on the GTS Controller PCB. When the toggle switch is activated (pushed down), and the Return to Utility timer is active, the remaining time on the timer is cleared. Once the timer is cleared, the GTS mechanism transfers and the LOAD is then connected to the UTILITY source.

If the toggle switch is not activated, the Return to Utility timer functions as normal. The retransfer of the GTS is delayed until it expires.

Figure 3.10 — Manual Bypass for Return to Normal

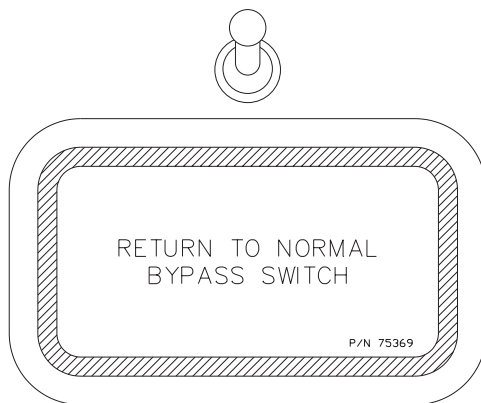

◆ 3.15.5 PREFERRED SOURCE SELECTOR SWITCH

The Preferred Source Selector Switch option includes a door mounted rotary two-position selector switch, customer connection terminal strip and associated wiring (Figure 3.11).

This option is normally used when there is not a UTILITY supply present and both sources are a generator. It may be used when it is necessary for either source of power to serve as the preferred source. The other power source then becomes the backup source. The switch is manually operated.

Figure 3.11 — Preferred Source Selector Switch

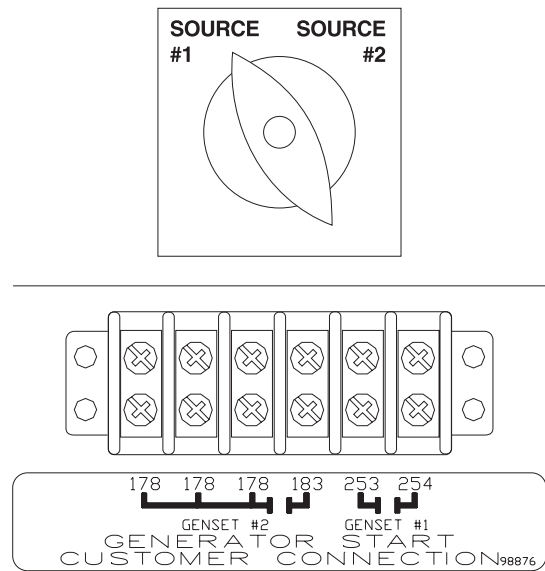

When the rotary switch is in position Source #1, the GTS performs as a normal system. Generator #1 is the primary source and generator #2 is the backup source.

When the rotary switch is in position #2, the GTS signals generator #2 to start and the GTS transfers the LOAD to generator #2. If Source #2 fails, Source #1 is signaled to start. The GTS mechanism transfers the LOAD to Source #1. When Source #2 returns to service, the GTS transfers the LOAD to Source #2.

Reference wiring diagram OD8035 for further details. The customer connections are made on TS2. The associated wire numbers are 178, 183, 253 and 254.

### ◆ 3.15.6 MANUAL THREE-POSITION SELECTOR SWITCH (NORMAL-AUTO-STANDBY)

The Manual Three-position Selector Switch option includes a door mounted rotary Three-position selector switch and associated wiring (Figure 3.12).

Under certain conditions, it may be necessary to manually select the active power source. This can be done by means of the door mounted selector switch. The Normal - Auto - Standby, three-position selector switch provides the following:

1. When the switch is set to the NORMAL position, the LOAD is connected to the NORMAL source and any other transfer is inhibited.
2. When the switch is set to the AUTO position, the ATS functions as normal. See the Sequence of Operation, Section 3.13.
3. When the switch is set to the Standby position, the LOAD is connected to the Emergency source and any other transfer is inhibited.

Reference the wiring diagram OD8035 for further details.

Figure 3.12 — Manual 3-Position Switch

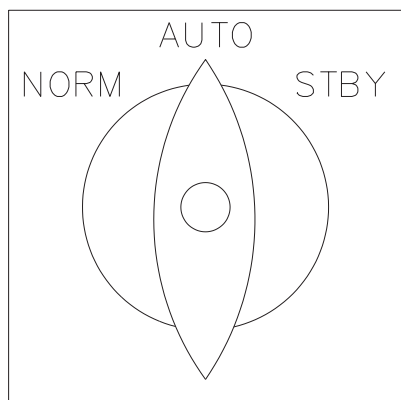

### ◆ 3.15.7 NEMA 12 ENCLOSURE

This type of enclosure is intended for use indoors to provide a degree of protection against dust, falling dirt, and dripping, non-corrosive liquids. Ask a Dealer/Distributor for details.

### ◆ 3.15.8 NEMA 3R ENCLOSURE

This type of enclosure is intended for use outdoors to protect enclosed parts from windblown dust and water. The enclosure is sealed for dust, rain or sleet and is ice resistant. Ask a Dealer/Distributor for details.

### ◆ 3.15.9 NEMA 4 ENCLOSURE

This type of enclosure is intended for use indoors or outdoors to provide a degree of protection against wind-blown dust and rain, splashing water, hose-directed water, and is undamaged by the formation of ice on the enclosure. Ask a Dealer/Distributor for details.

### ◆ 3.15.10 NEMA 4X ENCLOSURE

This type of enclosure is intended for use indoors and outdoors to provide a degree of protection against corrosion, windblown dust and rain, splashing water, hose-directed water, and is undamaged by the formation of ice on the enclosure. Ask a Dealer/Distributor for details.

### ◆ 3.15.11 ADDITIONAL OPTIONS

For information on additional options not covered in this manual, ask a Dealer/Distributor.

## 3.16 SENSOR AND TIMER ADJUSTMENTS – SENSING CIRCUIT BOARD

### ◆ 3.16.1 VOLTAGE DROPOUT SENSOR

This sensor (Figure 3.12) establishes the NORMAL power source voltage which generator startup and transfer to STANDBY (EMERGENCY) power source occurs. Adjust the sensor to any voltage between 75-95% of the nominal voltage Pickup Sensor setting, by turning the adjusting knob to the desired setting (in percent). Sensor is factory set to about 90% of the Voltage Pickup Sensor setting.

### ◆ 3.16.2 VOLTAGE PICKUP SENSOR

Establishes the NORMAL power source voltage at which re-transfer back to that power source occurs. Turn knob to adjust setting to 85-95% of the nominal NORMAL source supply voltage. Sensor has been factory set to about 90% of nominal rated NORMAL source voltage.

### ◆ 3.16.3 LINE INTERRUPT DELAY TIMER

Establishes a definite time interval between NORMAL source voltage dropout below the setting of the Voltage Dropout Sensor and generator startup. This time interval is necessary to prevent false generator starts that voltage transients might otherwise cause. Adjust timer from 0.1 to 10 seconds. Factory set to about five seconds.

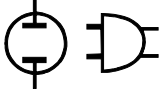
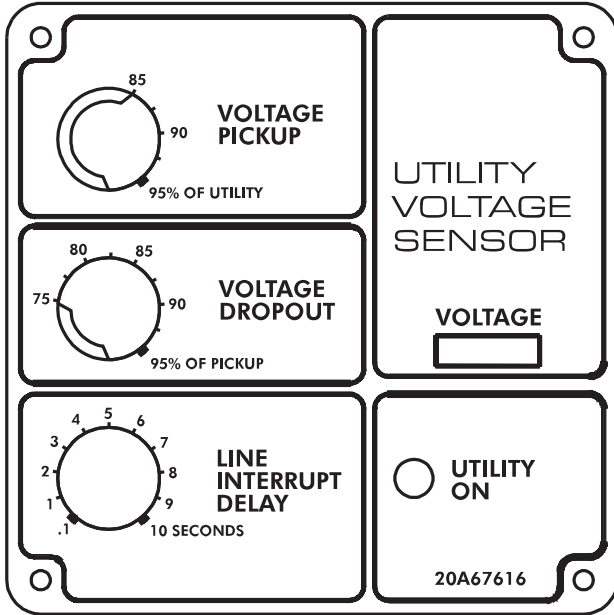

Figure 3.12 — Sensing Circuit Board Panel



### 3.17 ADJUSTMENTS ON INPHASE MONITOR CONTROL CIRCUIT BOARD

The Inphase Monitor Control board is operational only when the generator set is running and producing electricity. Transfer occurs when UTILITY and GENERATOR voltage and phase are comparatively equal with a maximum difference of 20° between the power sources. To assure precision matching control, minimum voltage and frequency ranges are specified by the operator. In addition, each inphase control is programmed with the use of an onboard DIP switch to match the actuation time of the corresponding switch. Inphase transfer is used only between two live power sources and NOT during a UTILITY source failure. The Inphase Monitor Control board (Figure 3.13) is designed to transfer loads under the following conditions:

- When generator set frequency is between 58-62 Hertz (48-52 Hertz for 50 Hertz systems).
- When generator set and utility power source frequencies are within two Hertz.
- When the generator set and utility source voltage are within 85-100 percent of normal voltage.
- When both power sources are able to come into phase within 10 seconds.
- When less than 10 seconds has elapsed since the engine warmup timer has indicated “go ahead.”

Figure 3.13 — Inphase Monitor Control Panel

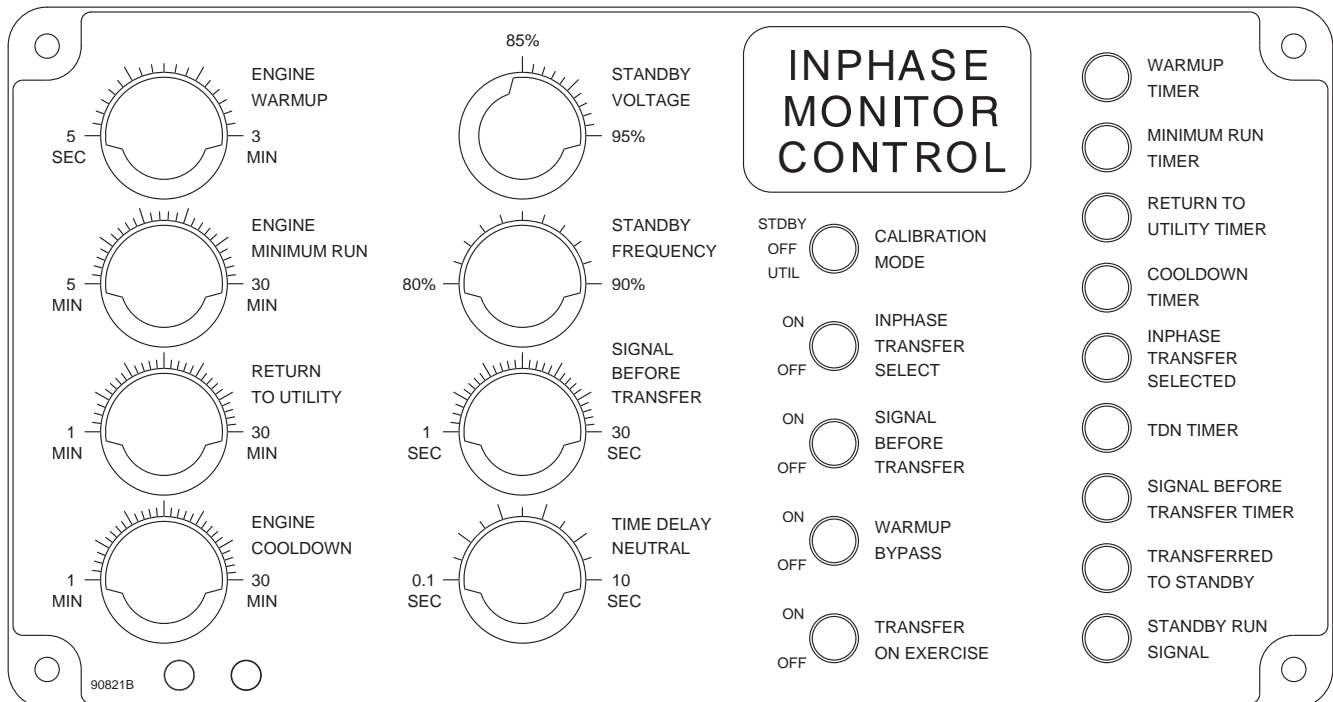

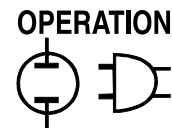

If any one of the preceding conditions are not met within 30 seconds, the system automatically reverts to Time Delay Neutral (if selected). If Time Delay Neutral is not selected, the switch transfers immediately after failing to do an inphase transfer within the 30 second window.

#### ◆ 3.17.1 ENGINE WARMUP TIMER

Allows the engine to warm up before transferring LOAD from NORMAL to STANDBY power. Reset timer to any time interval between five seconds and three minutes. Factory set to about one minute.

#### ◆ 3.17.2 ENGINE MINIMUM RUN TIMER

Establishes the minimum length of time the generator must run before it can be shut down automatically. Timer prevents a cold engine from being shut down. It is factory set to about 20 minutes, but the interval can be reset to between five and 30 minutes.

#### ◆ 3.17.3 RETURN TO UTILITY TIMER

Establishes time interval between restoration of NORMAL source voltage above the setting of the Voltage Pickup Sensor and re-transfer back to that source. This time interval is necessary, to prevent re-transfer that otherwise might occur as a result of transient voltages. Timer may be reset to any interval between one and 30 minutes. Factory set to about five minutes.

#### ◆ 3.17.4 ENGINE COOL DOWN TIMER

Provides a time delay between automatic re-transfer back to the NORMAL source and engine shutdown. This permits internal engine-generator temperatures to stabilize at “no-load” prior to shutdown. Set timer between one and 30 minutes. Factory set to about 10 minutes.

**NOTE:**

**The actual time interval between re-transfer back to NORMAL and generator shutdown, is the time remaining on Engine Minimum Run timer or time setting of the Engine Cool Down Timer, whichever is longer.**

#### ◆ 3.17.5 STANDBY VOLTAGE SENSOR

After engine starts automatically, the system does not transfer LOAD to STANDBY power source until generator AC output voltage has reached the setting of this sensor. Factory set to about 95% of the nominal rated voltage, but can be reset to between 85% and 95% of the unit’s rated voltage.

#### ◆ 3.17.6 STANDBY FREQUENCY SENSOR

This adjustment allows the installer or operator to select the minimum required frequency of the standby power source. It is adjustable between 80-90%. Factory set to 90%.

#### ◆ 3.17.7 SIGNAL BEFORE TRANSFER TIMER

With this function selected, the timer controls the amount of time signal remains active. Timer is adjustable from one to 30 seconds. Factory set to about 10 seconds.

**NOTE:**

**The “Signal Before Transfer” feature provides a time delay that allows elevators to continue operating before transfer to another power supply occurs.**

#### ◆ 3.17.8 TIME DELAY NEUTRAL

This timer holds the transfer mechanism’s main contacts in the “Neutral” position for the time selected. “Neutral” is the main contacts position where the LOAD is disconnected from both UTILITY and STANDBY power supplies. Timer is adjustable from 0.1 and 10 seconds. Factory set to about five seconds.

#### ◆ 3.17.9 CALIBRATION MODE SWITCH

This switch has three positions, identified as “STDBY”, “OFF” and “UTIL”. The switch allows the installer or operator to calibrate the circuit board to the existing generator set output voltage and to the existing UTILITY power source voltage. The board must be calibrated to both power source voltages in order to initiate transfer and re-transfer at the correct voltages. To calibrate the circuit board to the correct voltage, see “Calibrating the Circuit Board.”

#### ◆ 3.17.10 INPHASE TRANSFER SELECT SWITCH

This switch allows the operator or installer to select either “Inphase Transfer” or “Time Delay Neutral” operation. The switch may be positioned as follows:

- Switch at ON: Inphase transfer operation is selected.
- Switch at OFF: Time Delay Neutral is activated if selected.

#### ◆ 3.17.11 SIGNAL BEFORE TRANSFER SWITCH

This switch allows the operator or installer to select the “Signal Before Transfer” feature or to turn OFF the feature. To activate the feature, set the switch to ON. To turn off the feature, set the switch to OFF.

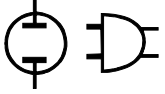

◆ **3.17.12 ENGINE WARMUP TIMER BYPASS SWITCH**

To bypass Engine Warmup Timer and transfer as soon as generator voltage and frequency have reached the setting of the Standby Voltage and Frequency Sensors, set switch to ON. To place engine warmup Timer back into the automatic operating system, set the switch to OFF.

◆ **3.17.13 TRANSFER ON EXERCISE SWITCH**

For transferring LOAD to the STANDBY source during the 7-day exercise cycle, set switch to ON. For no transfer during the exercise, set switch to OFF.

◆ **3.17.14 ADVISORY LAMPS**

The advisory lamps on the Inphase Control board consist of nine LED’s and include the following:

- The four red timer LED’s turn ON when their respective timers are activated.
- The “Inphase Transfer Selected” LED goes ON when Inphase Transfer Select switch is set to ON, indicating the system will operate in its “Inphase” mode (and NOT in Time Delay Neutral mode).
- The Time Delay Neutral (TDN) Timer LED turns ON when the TDN timer is running.
- The Signal Before Transfer Timer LED turns ON for the duration of the Signal Before Transfer Timer, when it is turned ON.
- Transfer to Standby LED goes ON when LOAD has been transferred to STANDBY power source.
- Standby run Signal goes ON when the generator is running and the Inphase Monitor Control circuit board is operational and controlling the generator.

**3.18 CALIBRATING THE INPHASE MONITOR CONTROL CIRCUIT BOARD**

The Inphase Monitor circuit board must be calibrated to existing STANDBY and UTILITY source voltages if the system is to operate properly. To calibrate the circuit board, two adjustment potentiometers (R102 and R107) are provided in the lower left corner of the circuit board (Figure 3.14). The board must be calibrated as follows:

1. Check that UTILITY supply voltage is available to the system.
2. Start the generator, let it stabilize and warm up.
3. Set the Calibration Mode Switch to “STDBY” and observe the four top LED’s on the circuit board (Warmup Timer, Minimum Run Timer, Return to Utility Timer and Cool down Timer). These are the RED LED’s.
  - If the two upper LED’s are illuminated, calibration is set too low.
  - If the two bottom LED’s are illuminated, calibration is set too high.

4. On the circuit board, adjust potentiometer R102 until only the two center LED’s are illuminated (Minimum Run and Return to Utility timers).
5. Now, set the Calibration Mode switch to “UTIL” and observe the four upper LED’s on the circuit board.

**Figure 3.14 — Inphase Monitor Control Circuit Board**

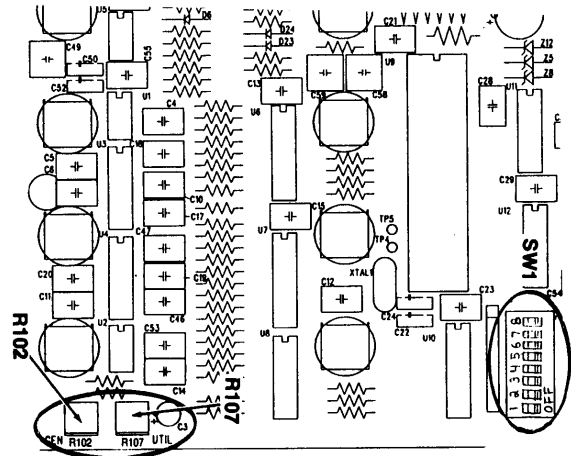

6. Adjust potentiometer R107 until only two center LED’s are illuminated (Minimum Run and Return to Utility).
7. Set the Calibration Mode Switch to “OFF”. The Inphase Monitor Control board is calibrated.

**NOTE:**

**With the Calibration Mode Switch set to “STDBY” or “UTIL”, the four top LED’s should turn ON in sequence. That is, the lights should sweep on and off, from one light to the next. Calibration is obtained when the two center lamps of the four (Minimum Run and Return to Utility) are illuminated. This establishes 100% rated voltage.**

**NOTE:**

**The Inphase Monitor Control circuit board should be calibrated when the transfer switch has been installed as part of an operating system. Also, replacement circuit boards must be calibrated.**

**3.19 CIRCUIT BOARD SWITCH SW1**

On the Inphase Monitor Control Board, a switch assembly consisting of a bank of eight miniature switches is identified as “SW1” is usually set up at the factory and should require no additional configuring (Figure 3.15).

**NOTE:**

**On boards not installed at the factory, SW1 must be set by the installer. SW1 must be set to match the type of transfer switch in which the board is installed.**

The individual switches on SW1 are numbered from “1” (bottom) through “8” (top), as shown in figures 3.14 and 3.15. To make the circuit board compatible to the specific transfer switch assembly, set the switches as indicated in the chart at the bottom of this page. Improper settings may cause transfer outside the 20-degree specification.

Figure 3.15 — Circuit Board Switch SW1

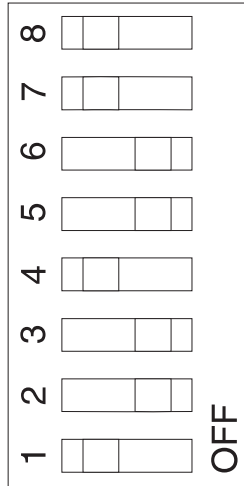

### 3.20 EXERCISE TIMER DISPLAY (FIGURE 3.16)

#### ◆ 3.20.1 CURRENT TIME

The current time is selected with the time push-button and is displayed in 12:00 hour format on four, seven segment LED displays. The colon flashes at a rate of 0.5 seconds on/off to indicate normal operation and display of the current time.

Figure 3.16 — Display

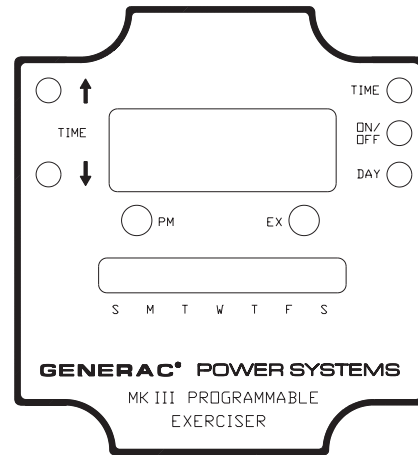

#### ◆ 3.20.2 EXERCISE TIME

The exercise time is selected with the time push-button, the exercise time for the selected day is displayed in a similar format to current time, except that the colon does not flash but is always ON to indicate that the exercise time is being displayed.

To change the exercise day that is being displayed, use the “day” push-button when in this mode.

#### ◆ 3.20.3 PM (TIME)

A single LED indicates PM (ON) time or AM (OFF).

#### ◆ 3.20.4 DAY OF WEEK

The day of the week is indicated on the seven individual day LEDs which represent Sunday through Saturday.

### DIP Switch Settings - W-Type Transfer Switches

TRANSFER SWITCH	SWITCH RATED 100/200; 110/220; 115/200; 120/208; 220/380 VOLTS								SWITCH RATED 120/240; 231/400; 240/416 VOLTS								SWITCH RATED 277.480; 346/600 VOLTS							
	1	2	3	4	5	6	7	8	1	2	3	4	5	6	7	8	1	2	3	4	5	6	7	8
100 amps, 2-pole (0D7300)	*	on	off	off	on	off	off	on	*	on	off	off	on	off	off	on	*	on	off	off	on	off	on	off
100 amps, 3-pole (0D7301)	*	on	off	off	on	off	off	off	*	on	off	off	on	off	off	on	*	on	off	off	on	off	on	off
100 amps, 4-pole (0D7302)	*	on	off	off	on	on	off	off	*	on	off	off	on	on	on	off	*	on	off	off	on	on	on	off
150 amps, 2 pole (0C8881)	*	on	off	off	on	on	off	on	*	on	off	on	off	off	off	off	*	on	off	off	on	on	on	off
150 amps, 3-pole (0C8882)	*	on	off	off	on	on	on	off	*	on	off	on	off	off	off	off	*	on	off	on	off	off	off	off
150 amps, 4-pole (0C8883)	*	on	off	on	off	on	on	off	*	on	off	on	on	off	off	off	*	on	off	on	off	on	on	off
200 amps, 2-pole (0C8884)	*	on	off	off	on	on	off	on	*	on	off	on	off	off	off	off	*	on	off	off	on	on	on	off
200 amps, 3-pole (0C8885)	*	on	off	off	on	on	on	off	*	on	off	on	off	off	off	off	*	on	off	on	off	off	off	off
200 amps, 4-pole (0C8886)	*	on	off	on	off	on	on	off	*	on	off	on	on	off	off	off	*	on	off	on	off	on	on	off
300 amps, 2-pole (0D7297)	*	off	on	off	on	on	on	off	*	off	on	on	off	off	off	on	*	off	on	off	on	on	on	on
300 amps, 3-pole (0D7298)	*	off	on	on	off	off	off	off	*	off	on	on	off	off	off	on	*	off	on	on	off	off	off	on
300 amps, 4-pole (0D7299)	*	off	on	on	off	off	off	on	*	off	on	on	off	on	on	on	*	off	on	on	off	on	on	off
400 amps, 2-pole (0D7294)	*	off	on	on	off	on	on	off	*	off	on	on	off	off	off	on	*	off	on	on	off	on	on	on
400 amps, 3-pole (0D7295)	*	off	on	on	off	off	off	off	*	off	on	on	off	off	off	on	*	off	on	on	off	off	off	on
400 amps, 4-pole (0D7296)	*	off	on	on	off	off	off	on	*	off	on	on	off	on	on	on	*	off	on	on	off	on	off	off

\* Set Switch 1 to OFF for 60 Hertz systems; set Switch to ON for 50 Hertz systems

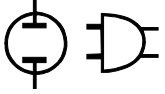

### ◆ 3.20.5 EXERCISE ON (EX)

A single LED indicates that the relay output is switched ON (exercise period).

### ◆ 3.20.6 POWER SAVING

To minimize the power consumption of the unit, the unit will switch to a “dim” display mode of no keyboard activity is noted for five minutes. The display brightness is reduced to 50% of normal, but returns to 100% when any key is pressed.

### ◆ 3.20.7 DEFAULT TIMES

When the exerciser is first powered up, or if power is removed from the unit and the battery backup has expired, the default times will revert to:

Current time	9:00 am
Current day	Sunday
Sun-Sat exercise	9:00 am
Exercise period	20 minutes

## 3.21 EXERCISE TIMES

Exercise times may be set individually on a day by day basis. Exercise periods can overlap day's. For example, if a time is set for 11:55 pm Sunday for 20 minutes, it will turn off at 12:15 am Monday.

The exercise period is globally programmable (common to all days), and is limited from 10-119 minutes.

## 3.22 PUSHBUTTONS (FIGURE 3.16)

### ◆ 3.22.1 UP ARROW ↑

The up arrow is used to step the time forward in increments of one minute. This feature has auto-acceleration such that if the button is held on, the step frequency progressively increases to allow fast searching of a required time. As soon as the button is released, it reverts to normal speed.

### ◆ 3.22.2 DOWN ARROW ↓

The down arrow is used to step the time backwards in increments of one minute. It also has auto-acceleration.

### ◆ 3.22.3 TIME (TIME/ALARM TOGGLE)

This toggles the display between normal current time display and exercise time. When in exercise time mode the following happens:

1. The colon stops flashing to indicate exercise time mode.
2. The Sun LED flashes to indicate that it is initially selected. The rate of flashing is either:
  - 50/50% on/off to indicate exercise time is enabled.
  - 90/10% on/off to indicate exercise time is not enabled.

3. All other days that have exercise times enabled to ON are indicated by LED ON, days that are disabled are set to LED OFF.

If the display is inadvertently left in this mode with no keyboard activity for more than five minutes, it reverts back to normal (current time) display.

### ◆ 3.22.4 ON/OFF (ALARM SELECT TOGGLE)

When in exercise mode, this button toggles the exercise enable/disable status of the displayed day. The rate of flashing changes as above.

### ◆ 3.22.5 DAY

The day button is used to step forward through the days in either the current time or exercise time:

- In current time mode, the days step through seven states indicating Sunday to Saturday.
- In exercise time mode, the days step through seven states indicating Sunday to Saturday and then display state eight - all days LEDs flashing on/off together which represents the global exercise time period. In this mode, the exercise period may be changed using the up/down arrows as above, but the on time is limited to between 10 and 119 minutes.

## 3.23 PROGRAMMING EXAMPLES

### ◆ 3.23.1 EXAMPLE 1 – CHANGE TIME FROM SUNDAY 9:00 AM TO WEDNESDAY 2:00 PM

1. Ensure that current time is displayed by flashing colon. If colon is not flashing, then press and release the “time” push-button once.
2. Press and hold the “Up arrow” push-button until the time steps to almost 2:00 pm - note that the pm LED will now be on.
3. Repeatedly press and release “Up arrow” push-button until exact time is obtained. If scrolled past 2:00 pm then use the “Down arrow” to step back to the required time.
4. Press the “Day” button to advance the day LED display until the LED next to “W” (Wednesday) is on.

### ◆ 3.23.2 EXAMPLE 2 – SET EXERCISER ON FOR 14 MINUTES MON-FRI AT 10:00 AM

1. Press and release the “time push-button once to display the exercise time for Sunday, indicated by a static (ON) colon and a flashing “Sun” LED. If the colon is still flashing, then repeat this step.
2. The “Sun” LED should be flashing on/off 90:10, ON but briefly flashes OFF once every two seconds. This means that the exercise time is correctly set to OFF for Sunday. If it is 50:50, this indicates that the exercise time is set to ON, so press and release the “on/off” push-button once to toggle this state to OFF.

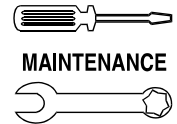

3. Press and release the “day” button to advance from Sunday to Monday, indicated by the “Mon” LED flashing.
4. Press and release the “on/off” push-button once to toggle the exercise state from OFF to ON. This is indicated by the “Mon” LED now flashing on/off 50:50 approximately four times per second as described previously.
5. Repeat steps 3 and 4 for Tues., Wed., Thurs. and Fri. ensuring the correct on/off exercise status for each day.
6. Press and release the “day” button once more and the display now shows “0:20” which is the exercise period in minutes. This is common for all days and this display mode is indicated by all seven “day” lights flashing simultaneously.
7. Use the Up/Down arrows to change the exercise period to 14 minutes.
8. Press and release the “time” push-button once to return the display mode to the current time.

### 3.24 CALIBRATE UTILITY VOLTAGE SENSING CIRCUIT BOARD

The Utility Sensing Interface reduces utility source voltage at a fixed ratio. Therefore, if utility voltage varies from the nominal, sensing voltage to the circuit board also varies. For that reason, the circuit board may need to be calibrated to match the system (Figure 3.17).



**The installed transfer switch must be rated at a voltage and phase that is compatible with the UTILITY and STANDBY power supplies. DO NOT attempt to calibrate any utility voltage sensor board on any non-compatible unit trying to make the unit compatible.**

Once the circuit board has been properly calibrated, the voltage that was present during calibration establishes 100 percent utility voltage for “pickup” and “dropout” settings. Utility source voltage must be available to the transfer switch during calibration.

**NOTE:**

**Also use this procedure to calibrate a replacement circuit board. Follow these instructions:**

1. In the transfer switch enclosure, set the Maintenance Disconnect Switch to MANUAL.
2. On the Utility Voltage Sensor circuit board, locate test points “TP3” and “TP4” and install a jumper lead.
3. Locate the small potentiometer “R10”. Turn the potentiometer fully counterclockwise.
4. Now, turn the “R10” potentiometer SLOWLY clockwise until the “Utility On” LED just turns ON.
5. Remove the jumper wire from “TP3” and “TP4”.
6. Reset the Maintenance Disconnect switch to AUTOMATIC.

**RESULTS:**

- If the “Utility On” LED does NOT go on as described above, replace the Utility Voltage Sensor board. Calibrate the new board and perform a “Normal Test” of the system.
- If the “Utility On” LED goes ON, discontinue the test.

**Figure 3.17 — Utility Voltage Sensing Circuit Board**

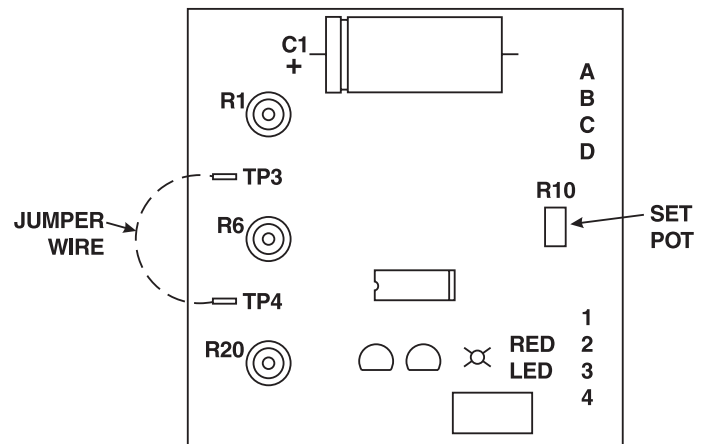

#### 4.1 OPERATE TRANSFER SWITCH

Operate the transfer switch at least once each month. This can be done by performing a NORMAL TEST of the system. Because the System Test switch only simulates failure of the UTILITY power source, service is interrupted only during the actual transfer of the load.

#### 4.2 CLEAN AND INSPECT TRANSFER SWITCH

Protect the transfer switch against construction grit, metal chips, excessive moisture and other harmful dirt at all times. At least once each year, turn OFF all power supplies to the switch, then brush and vacuum away dust and dirt that has accumulated inside the enclosure. After cleaning, inspect the transfer switch carefully. Look for evidence of arcing, burning, hot spots, charring and other damage. If any of these are found, have the switch assembly checked by an authorized service technician.

#### 4.3 LUBRICATION

Operating parts inside the transfer mechanism have been properly lubricated at the time of assembly. Under normal conditions, no additional lubrication should be required. The service technician should lubricate all recommended points whenever major transfer mechanism components are replaced.

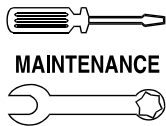

MAINTENANCE

## Section 4 – Maintenance

### Generac GTS “W” Type Transfer Switch

---



CAUTION



**Use only specified greases to lubricate contactor parts. DO NOT USE ANY SUBSTITUTES.**

Use the following lubricants for the:

1. Main Contacts (Between movable contact and bus-bars).
  - Dow Corning (Molykote) BR2 Plus (Mfg. by Dow Corning Co., USA)
  - Liqui-Moly (Mfg. by DAI TO Co., Ltd., Japan)
2. Operating Mechanism (Used on the actuator and other parts of the contactors. Excluding the movable contacts).
  - Mobilgrease 28 (Mfg. by Mobil Oil Co.)
  - Mobiltemp SHC 32 (Mfg. by Mobil Oil Co.)
  - Polo Moly Complex Grease #NLG12 (Mfg. by Polo Lubricants, USA)
  - Rheolube 363 (Mfg. by Nye Lubricants Inc., USA)

## 4.4 MAIN CURRENT CARRYING CONTACTS

At least once annually, have an Authorized Service Technician check the main current-carrying contacts in the transfer mechanism. They will repair or replace major components that have been found defective.

## 4.5 NINE-VOLT BATTERY

The transfer switch is equipped with an adjustable Inphase Monitor Control circuit board. The battery connects to a separate 7-day exerciser circuit board. Battery power for Exercise Timer operation is only needed during the short time interval when the transfer mechanism main contacts are at NEUTRAL position (LOAD disconnected from both power sources). It is recommended that the nine-volt battery be replaced once each year.



**100A (All System Voltages), 200-400A (208, 240VAC System Voltages) NEMA 1 Units**

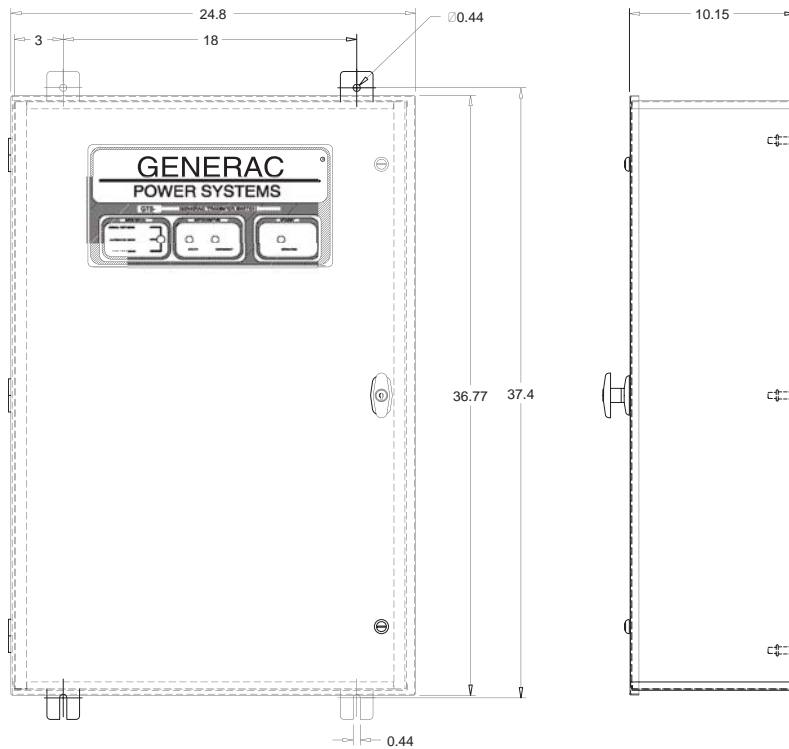

**200-400A (480, 600V System Voltages) NEMA 1 Units**

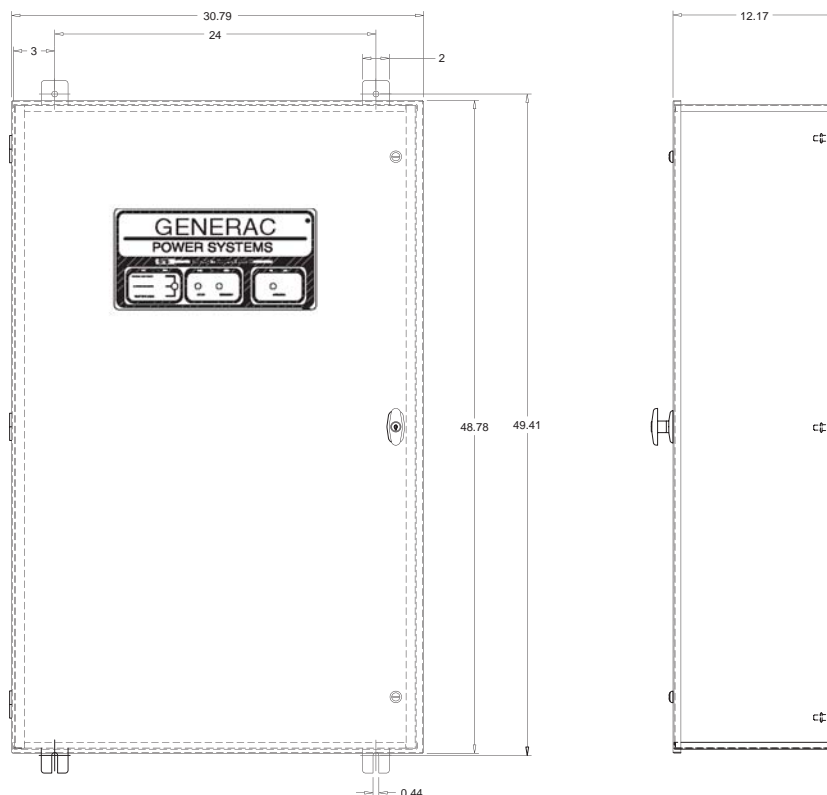

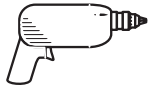

**100A (All System Voltages), 150-400A (208, 240VAC System Voltages) 3R, 4, and 4X Units (Typical)**

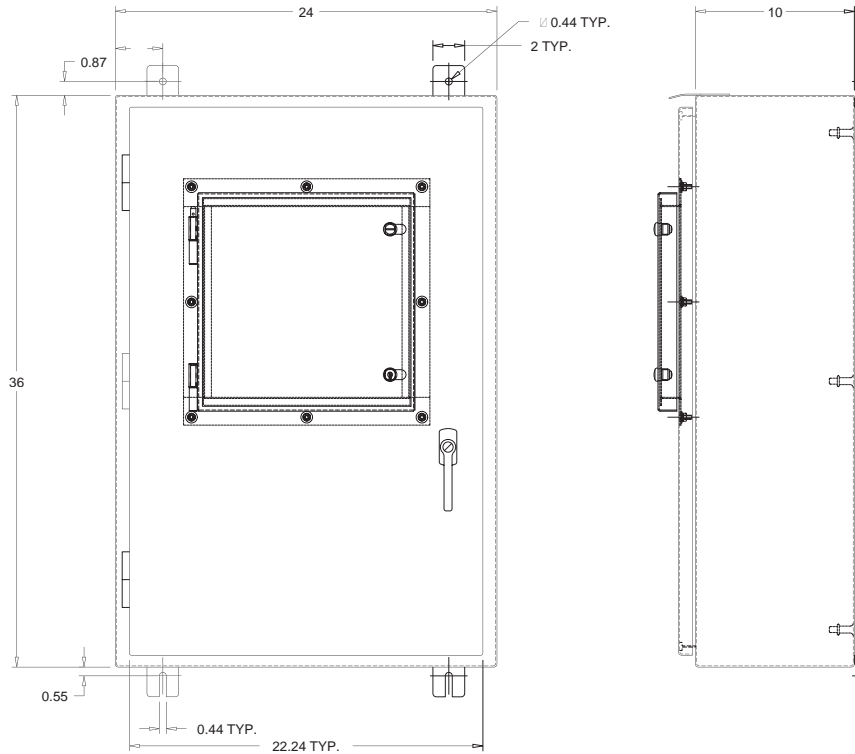

**150-400A (480, 600V System Voltages) 3R, 4 and 4X Units (Typical)**

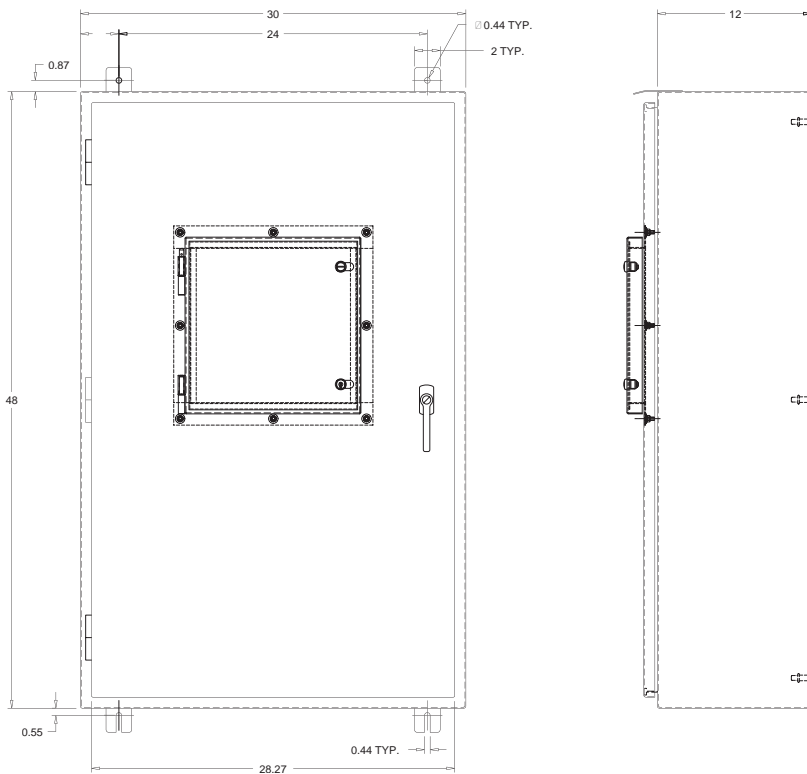



**100A (All System Voltages), 150-400A (208, 240VAC System Voltages)  
NEMA 12 Units With Instrument Package**

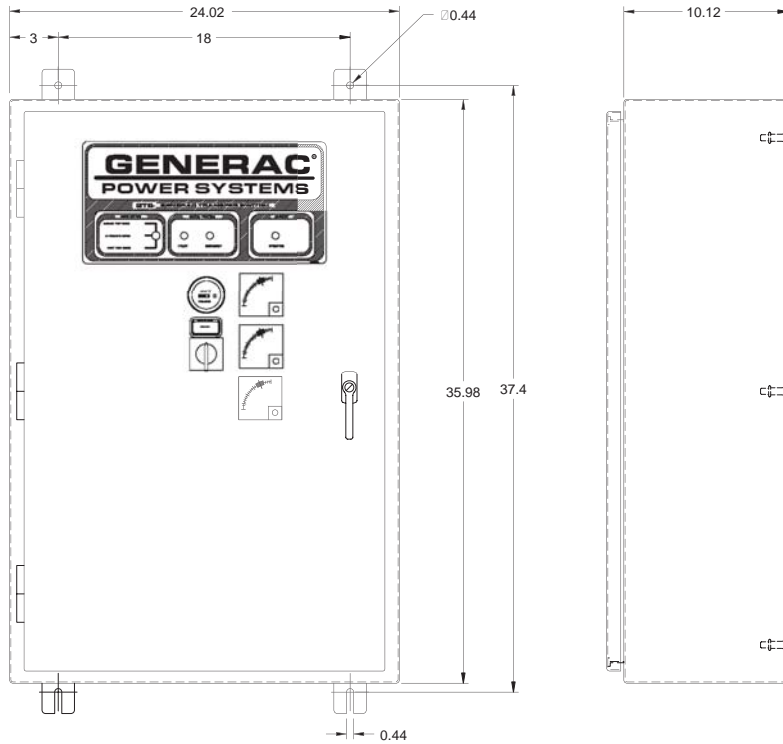

**150-400A (480, 600V System Voltages) NEMA 12 Units With Instrument Package**

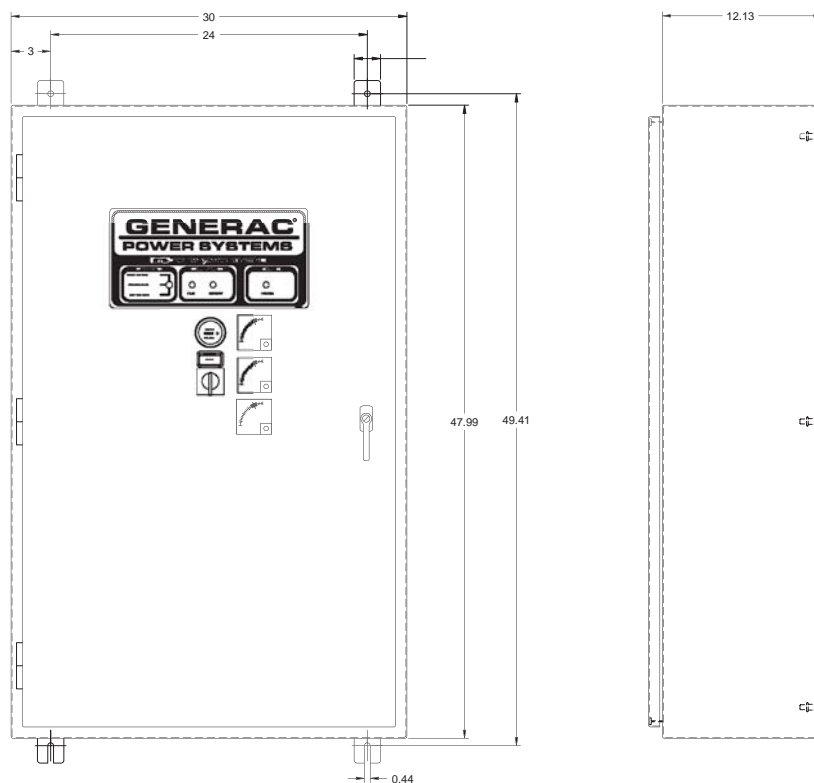



Section 6 – Wiring Diagrams & Electrical Schematics

Wiring Diagram - 208/240V – Drawing No. 0D8112-A

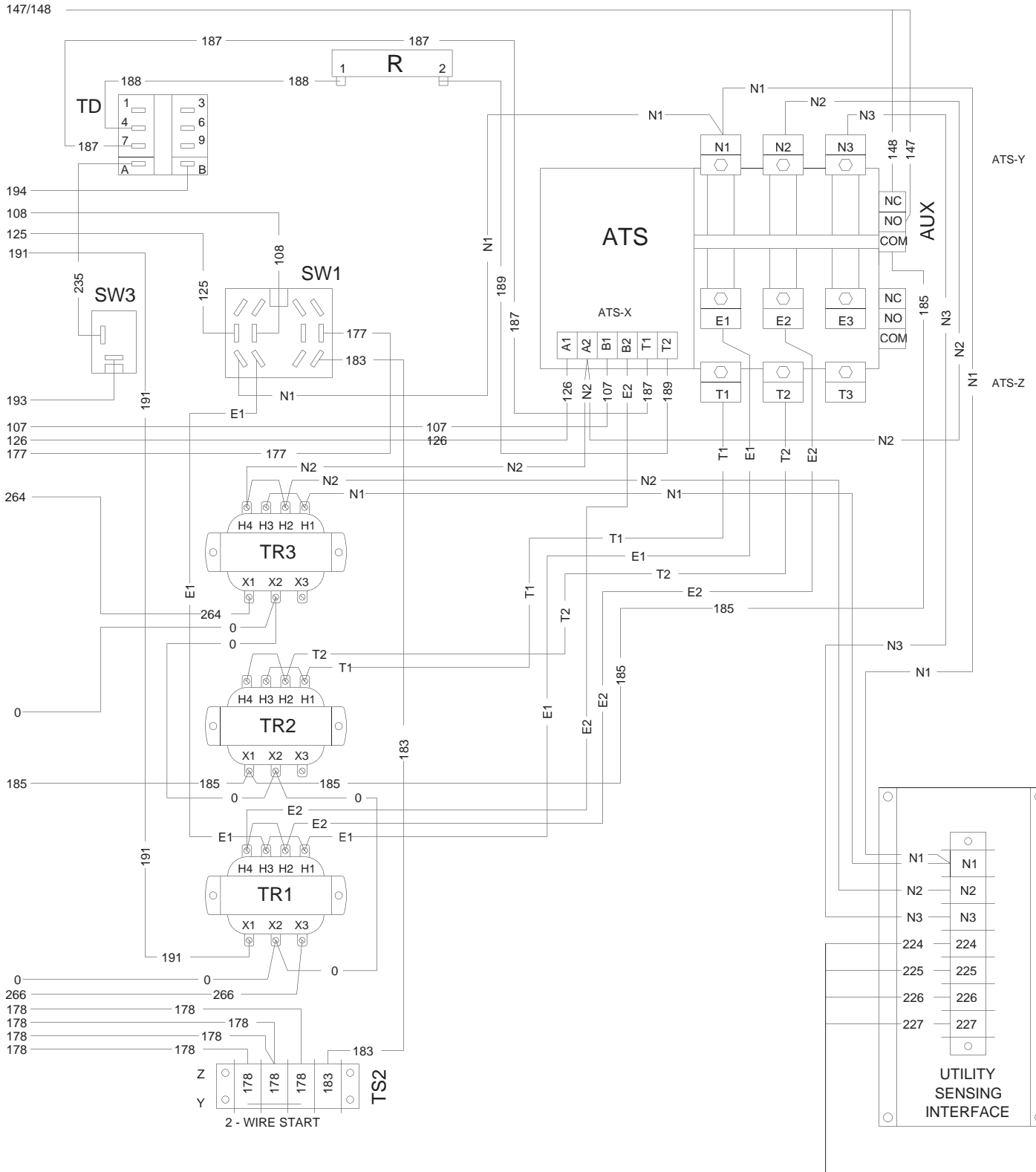
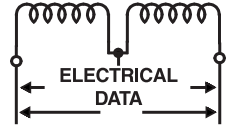

224-227

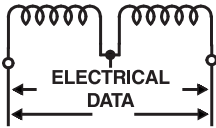

## Section 6 – Wiring Diagrams & Electrical Schematics

### Electrical Schematic - 208/240V – Drawing No. 0D8116-B

PSW CONTACTS	POSITION			OFF
	1	2	3	
2 - 3		X	X	X
2 - 7	X		X	X
2 - 11	X	X		X
12 - 3	X			
12 - 7		X		
12 - 11			X	
15 - 14	X			
15 - 18		X	X	
19 - 16	X	X		
19 - 14			X	

X INDICATES CLOSED

NOTE:

WIRE 59, N3, 226, AND CT3 USED ON 3-PHASE UNITS ONLY.

ALL RELAY CONTACTS SHOWN WITH ATS IN UTILITY POSITION.

WIRE T3 BECOMES 00 ON 120/240V 1-PHASE UNITS ONLY

AND CONNECTS FROM PSW TO THE NEUTRAL BLOCK.

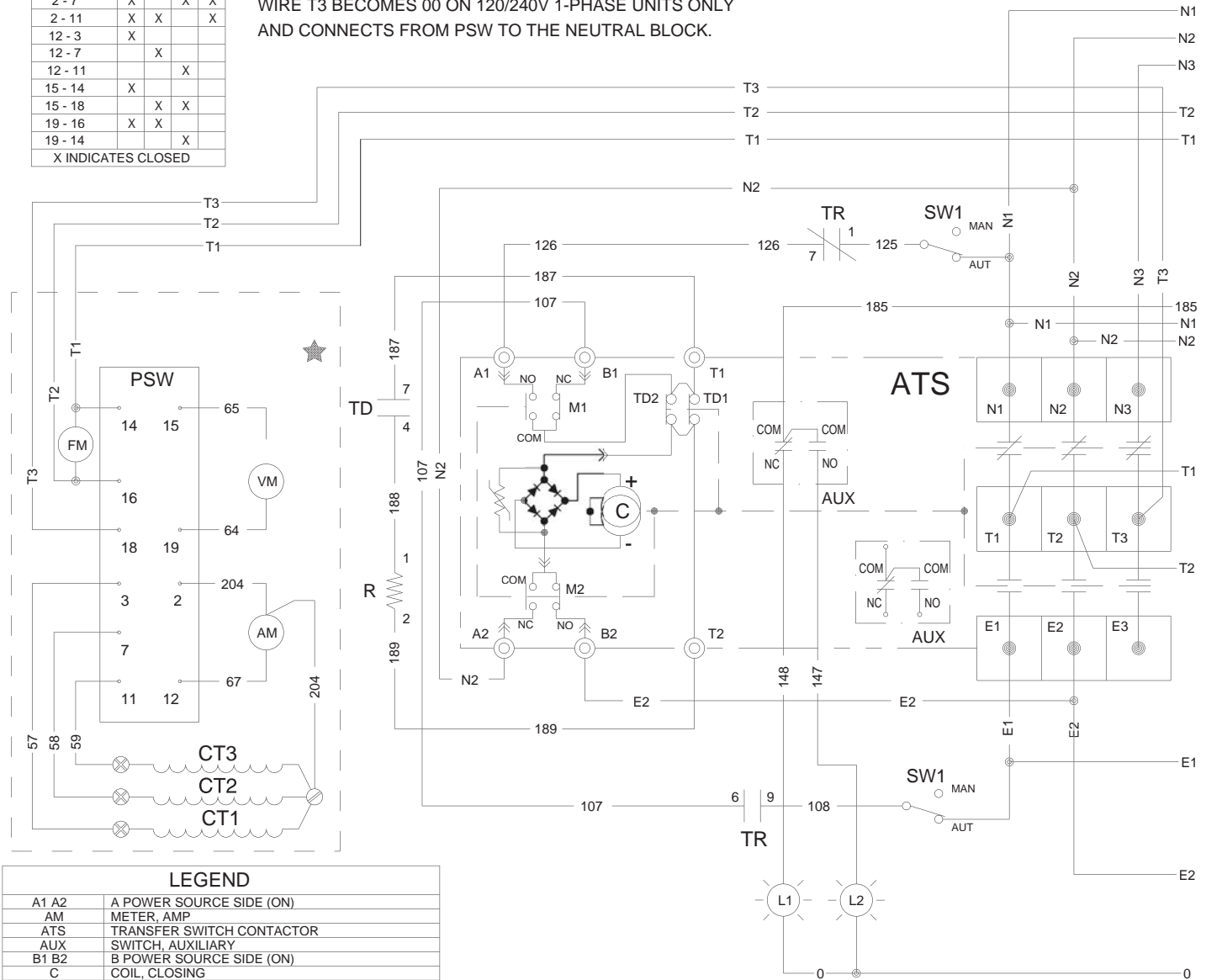

LEGEND	
A1 A2	A POWER SOURCE SIDE (ON)
AM	METER, AMP
ATS	TRANSFER SWITCH CONTACTOR
AUX	SWITCH, AUXILIARY
B1 B2	B POWER SOURCE SIDE (ON)
C	COIL, CLOSING
CT1,CT2,CT3	TRANSFORMER, CURRENT (OPT)
FM	METER, FREQUENCY
FWB	FULLWAVE BRIDGE RECTIFIER PKG
HM	METER, HOUR
L1	GREEN LIGHT, SWITCH POSITION UTILITY
L2	RED LIGHT, SWITCH POSITION EMERGENCY
L3	YELLOW LIGHT, STANDBY OPERATING
M1 & M2	LIMIT SWITCHES, ATS POSITION
PSW	SWITCH, PHASE SELECTOR
R	RESISTOR, (TDN)
SR	RELAY, SIGNAL BEFORE TRANSFER (OPT)
SW1	SWITCH, MAINTENANCE DISCONNECT
SW2	SWITCH, SYSTEM TEST
SW3	SWITCH, TDN ON/OFF
SW4	SWITCH, RETURN TO NORMAL BYPASS (OPT)
TD	RELAY, TIME DELAY
TD1 & TD2	CONTACTS, TIME DELAY
TR	RELAY, TRANSFER
TR1	TRANSFORMER, STANDBY SENSING
TR2	TRANSFORMER, LOAD POWER SUPPLY
TR3	TRANSFORMER, UTILITY SENSING
VM	METER, VOLT

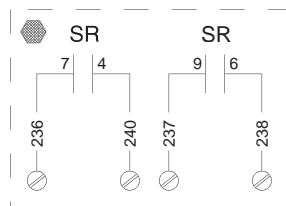

OPTIONS	
	SIGNAL BEFORE TRANSFER
	INSTRUMENT PACKAGE
	REMOTE AUTO START
	RETURN TO NORMAL BYPASS

Section 6 – Wiring Diagrams & Electrical Schematics

Electrical Schematic - 208/240V – Drawing No. 0D8116-B

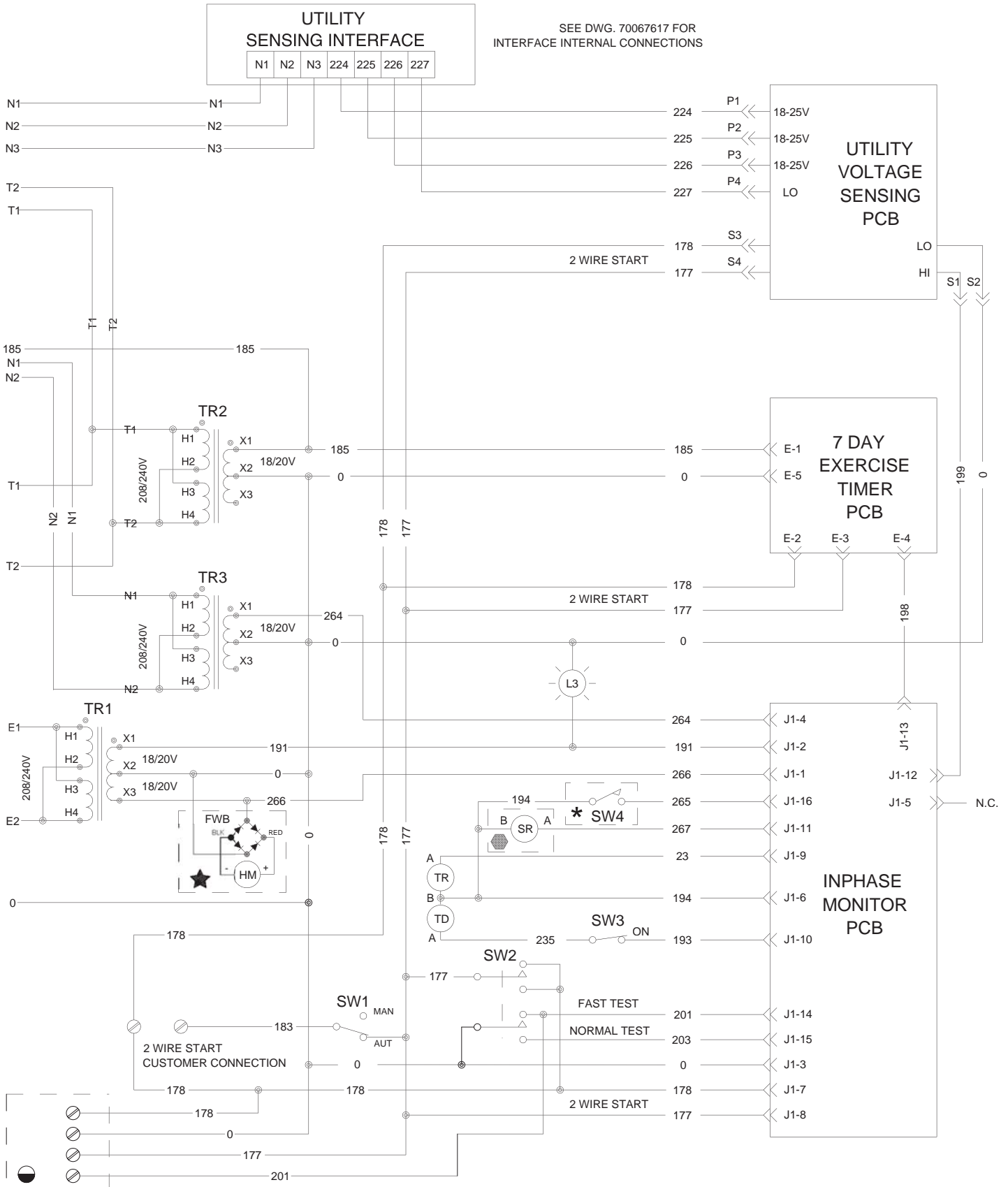
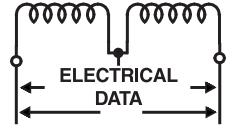

SEE DWG. 70067617 FOR  
INTERFACE INTERNAL CONNECTIONS

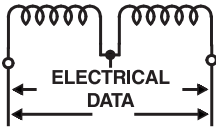

## Section 6 – Wiring Diagrams & Electrical Schematics

### Wiring Diagram - 416V 3-Pole – Drawing No. 0D8114-A

LEGEND	
ATS	TRANSFER SWITCH CONTACTOR
AUX	SWITCH, AUXILIARY
E	CONNECTOR, 7 DAY EXERCISER PCB
L1	GREEN LIGHT, SWITCH POSITION UTILITY
L2	RED LIGHT, SWITCH POSITION EMERGENCY
L3	YELLOW LIGHT, STANDY OPERATING
L-J1	CONNECTOR, INPHASE MONITOR PCB
P	CONNECTOR, UTILITY VOL. SENSING PCB
R	RESISTOR, TIME DELAY NEUTRAL (TDN)
S	CONNECTOR, UTILITY VOL. SENSING PCB
SW1	SWITCH, MAINTENANCE DISCONNECT
SW2	SWITCH, SYSTEM TEST
SW3	SWITCH, TDN ON/OFF
TD	RELAY, TIME DELAY
TR	RELAY, TRANSFER
TR1	TRANSFORMER, STANDBY SENSING
TR2	TRANSFORMER, LOAD POWER SUPPLY
TR3	TRANSFORMER, UTILITY SENSING
TS1	TERMINAL STRIP
TS2	TERMINAL STRIP, 2 WIRE START

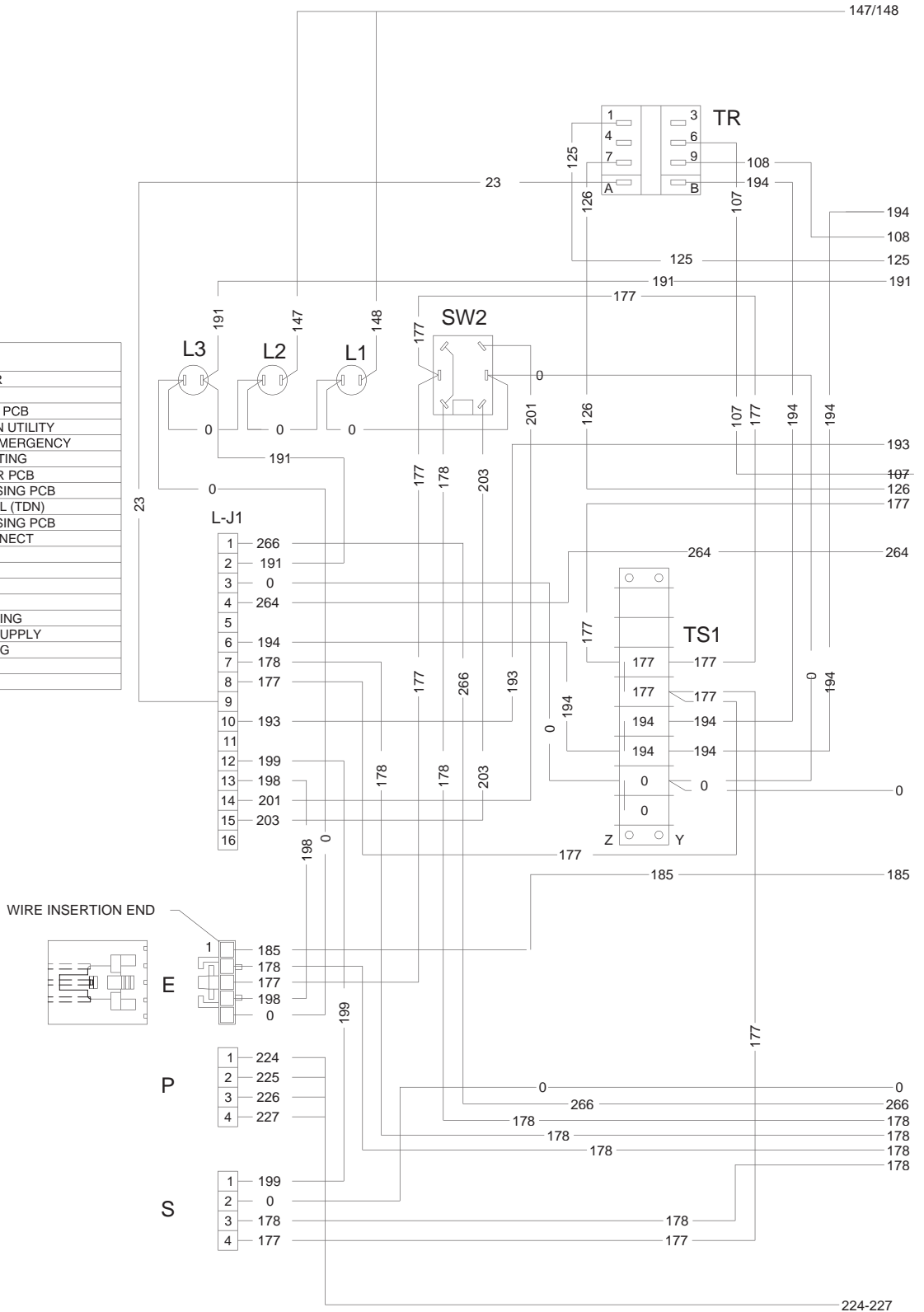



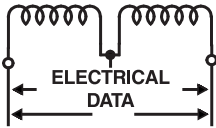

## Section 6 – Wiring Diagrams & Electrical Schematics

### Electrical Schematic - 416V 3-Pole – Drawing No. 0D8118-B

PSW CONTACTS	POSITION			
	1	2	3	OFF
2 - 3		X	X	X
2 - 7	X		X	X
2 - 11	X	X		X
12 - 3	X			
12 - 7		X		
12 - 11			X	
15 - 14	X			
15 - 18		X	X	
19 - 16	X	X		
19 - 14			X	

X INDICATES CLOSED

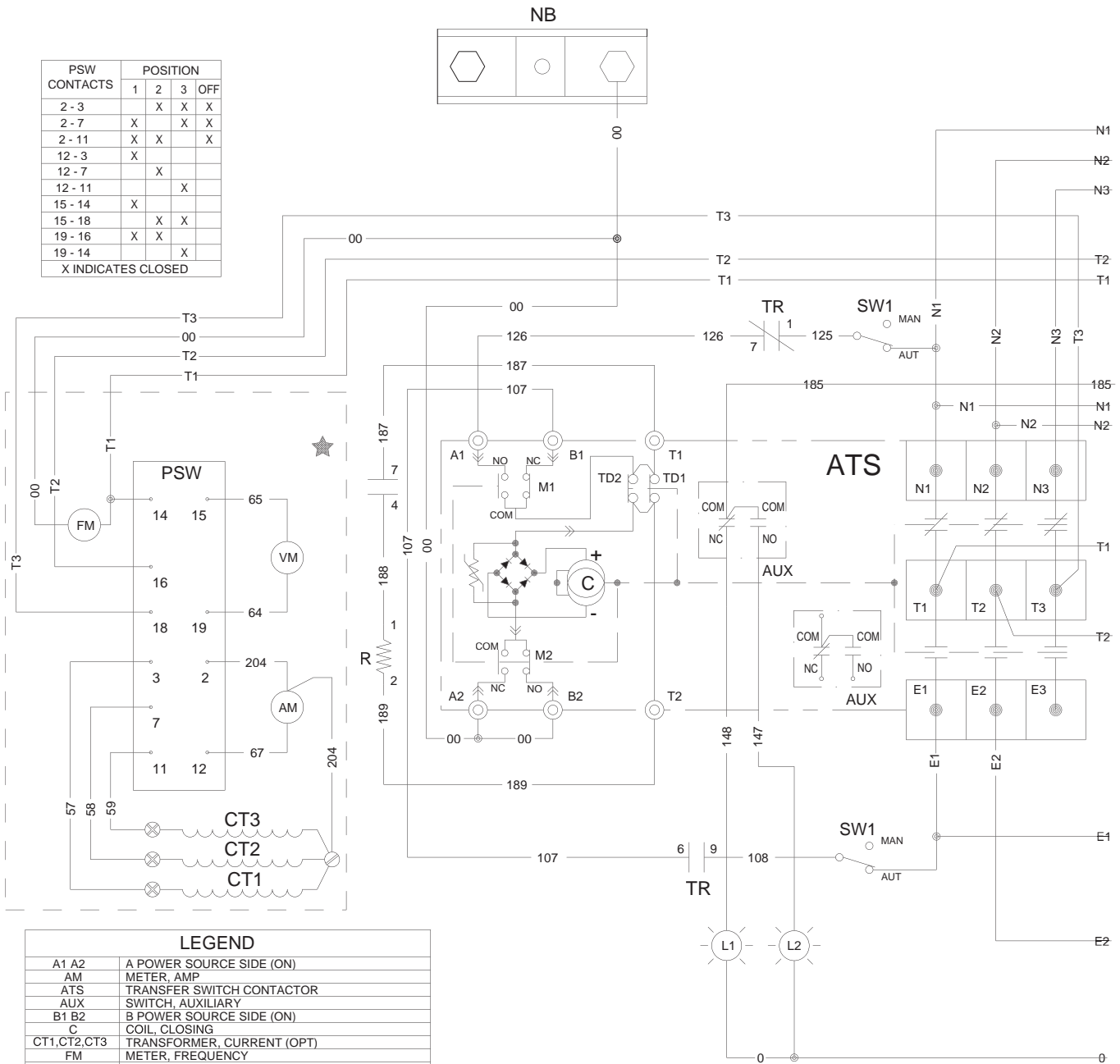

#### LEGEND

A1 A2	A POWER SOURCE SIDE (ON)
AM	METER, AMP
ATS	TRANSFER SWITCH CONTACTOR
AUX	SWITCH, AUXILIARY
B1 B2	B POWER SOURCE SIDE (ON)
C	COIL, CLOSING
CT1, CT2, CT3	TRANSFORMER, CURRENT (OPT)
FM	METER, FREQUENCY
FWB	FULLWAVE BRIDGE RECTIFIER PKG
HM	METER, HOUR
L1	GREEN LIGHT, SWITCH POSITION UTILITY
L2	RED LIGHT, SWITCH POSITION EMERGENCY
L3	YELLOW LIGHT, STANDBY OPERATING
M1 & M2	LIMIT SWITCHES, ATS POSITION
PSW	SWITCH, PHASE SELECTOR
R	RESISTOR, (TDN)
SR	RELAY, SIGNAL BEFORE TRANSFER (OPT)
SW1	SWITCH, MAINTENANCE DISCONNECT
SW2	SWITCH, SYSTEM TEST
SW3	SWITCH, TDN ON/OFF
SW4	SWITCH, RETURN TO NORMAL BYPASS (OPT)
TD	RELAY, TIME DELAY
TD1 & TD2	CONTACTS, TIME DELAY
TR	RELAY, TRANSFER
TR1	TRANSFORMER, STANDBY SENSING
TR2	TRANSFORMER, LOAD POWER SUPPLY
TR3	TRANSFORMER, UTILITY SENSING
VM	METER, VOLT

#### NOTE:

ALL RELAY CONTACTS SHOWN WITH  
ATS IN UTILITY POSITION

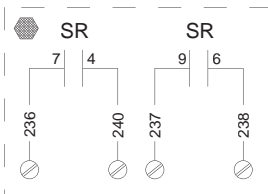

#### OPTIONS

- SIGNAL BEFORE TRANSFER
- INSTRUMENT PACKAGE
- REMOTE AUTO START
- RETURN TO NORMAL BYPASS

**Section 6 – Wiring Diagrams & Electrical Schematics**  
**Electrical Schematic - 416V 3-Pole – Drawing No. 0D8118-B**

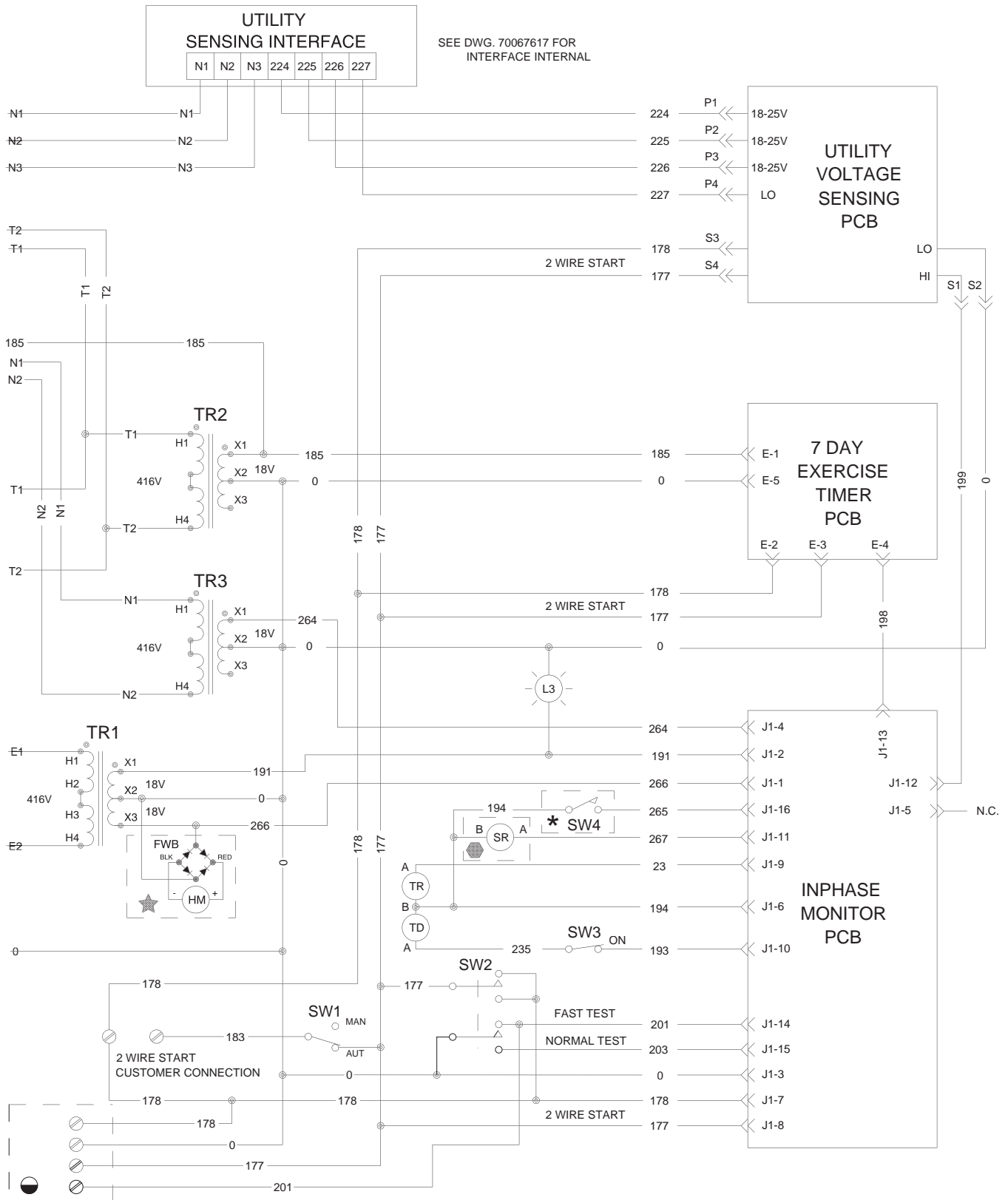
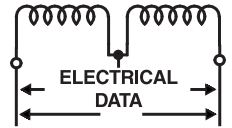





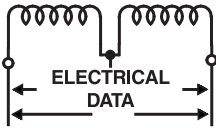

## Section 6 – Wiring Diagrams & Electrical Schematics

### Electrical Schematic - 416V 4-Pole – Drawing No. 0D8119-B

PSW CONTACTS	POSITION			
	1	2	3	OFF
2 - 3	X	X	X	X
2 - 7	X		X	X
2 - 11	X	X		X
12 - 3	X			
12 - 7		X		
12 - 11			X	
15 - 14	X			
15 - 18		X	X	
19 - 16	X	X		
19 - 14				X

X INDICATES CLOSED

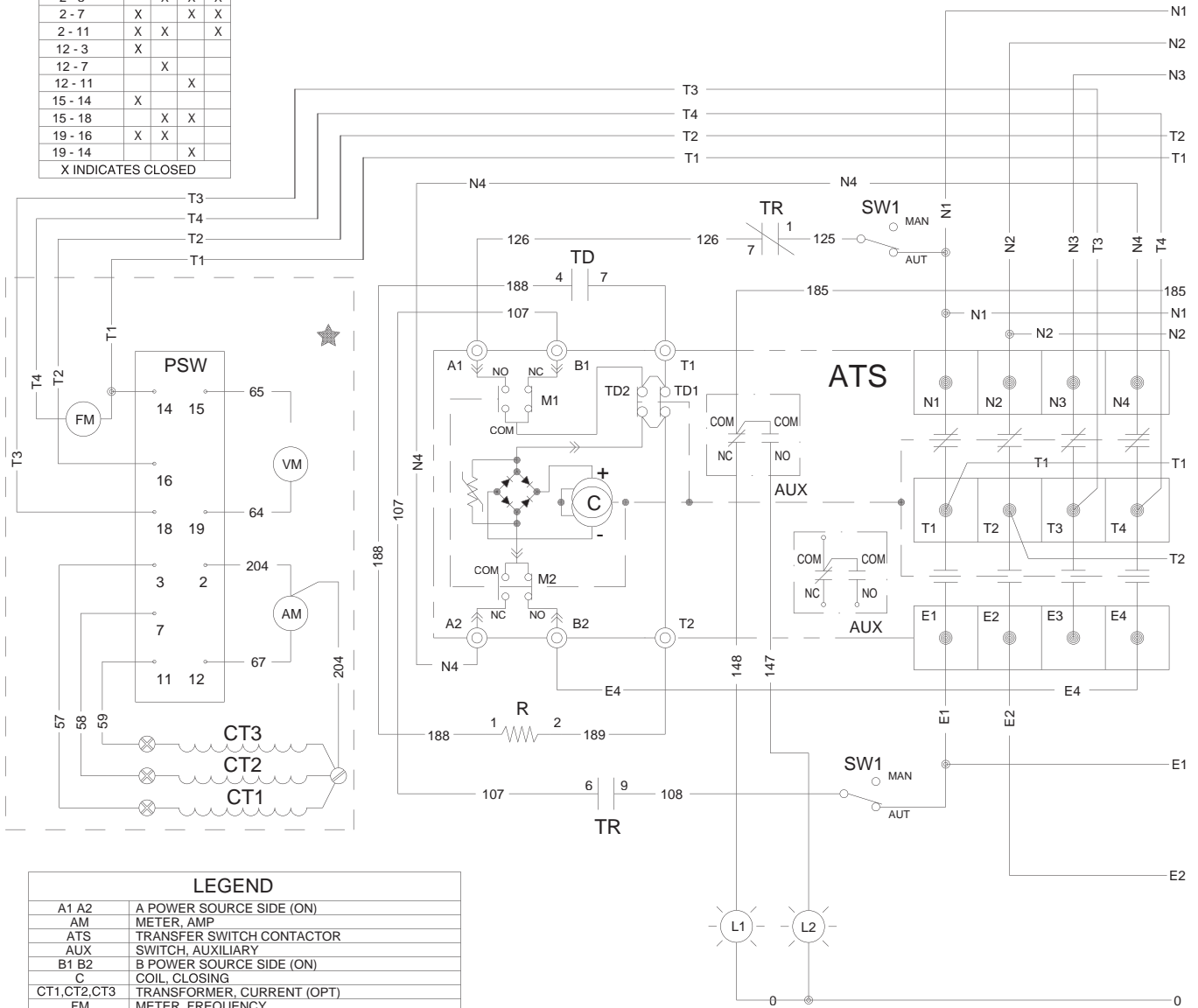

LEGEND	
A1 A2	A POWER SOURCE SIDE (ON)
AM	METER, AMP
ATS	TRANSFER SWITCH CONTACTOR
AUX	SWITCH, AUXILIARY
B1 B2	B POWER SOURCE SIDE (ON)
C	COIL, CLOSING
CT1, CT2, CT3	TRANSFORMER, CURRENT (OPT)
FM	METER, FREQUENCY
FWB	FULLWAVE BRIDGE RECTIFIER PKG
HM	METER, HOUR
L1	GREEN LIGHT, SWITCH POSITION UTILITY
L2	RED LIGHT, SWITCH POSITION EMERGENCY
L3	YELLOW LIGHT, STANDBY OPERATING
M1 & M2	LIMIT SWITCHES, ATS POSITION
PSW	SWITCH, PHASE SELECTOR
R	RESISTOR, (TDN)
SR	RELAY, SIGNAL BEFORE TRANSFER (OPT)
SW1	SWITCH, MAINTENANCE DISCONNECT
SW2	SWITCH, SYSTEM TEST
SW3	SWITCH, TDN ON/OFF
SW4	SWITCH, RETURN TO NORMAL BYPASS (OPT)
TD	RELAY, TIME DELAY
TD1 & TD2	CONTACTS, TIME DELAY
TR	RELAY, TRANSFER
TR1	TRANSFORMER, STANDBY SENSING
TR2	TRANSFORMER, LOAD POWER SUPPLY
TR3	TRANSFORMER, UTILITY SENSING
VM	METER, VOLT

NOTE:  
ALL RELAY CONTACTS SHOWN WITH  
ATS IN UTILITY POSITION

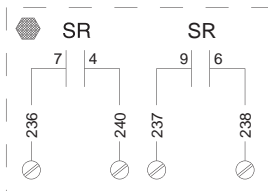

OPTIONS	
	SIGNAL BEFORE TRANSFER
	INSTRUMENT PACKAGE
	REMOTE AUTO START
	RETURN TO NORMAL BYPASS

**Section 6 – Wiring Diagrams & Electrical Schematics**  
**Electrical Schematic - 416V 4-Pole – Drawing No. OD8119-B**

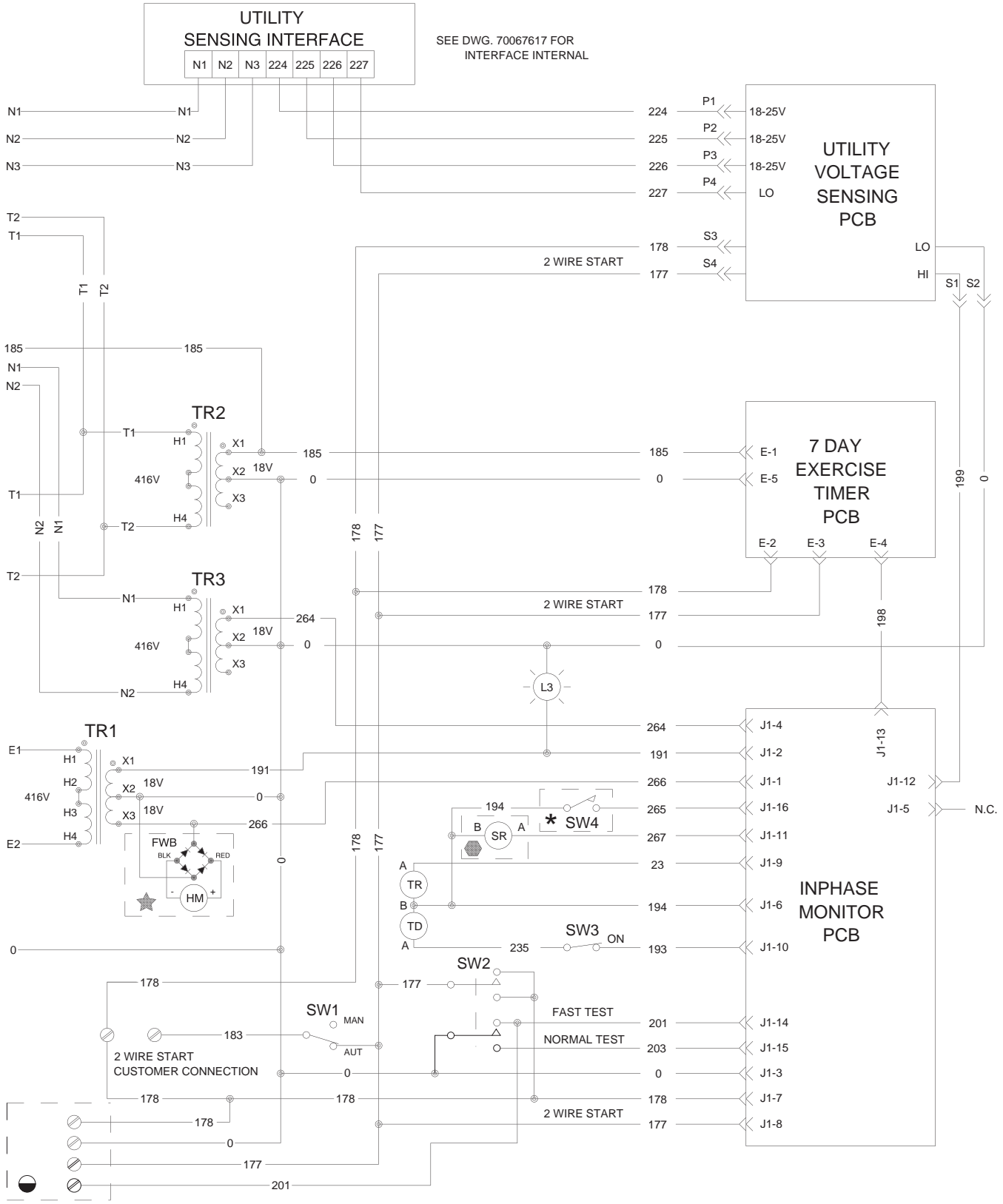
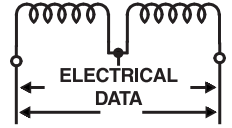

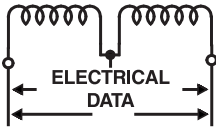

## Section 6 – Wiring Diagrams & Electrical Schematics

### Wiring Diagram - 480/600V – Drawing No. 0D8113-A

LEGEND	
ATS	TRANSFER SWITCH CONTACTOR
AUX	SWITCH, AUXILIARY
E	CONNECTOR, 7 DAY EXERCISER PCB
L1	GREEN LIGHT, SWITCH POSITION UTILITY
L2	RED LIGHT, SWITCH POSITION EMERGENCY
L3	YELLOW LIGHT, STANDY OPERATING
L-J1	CONNECTOR, INPHASE MONITOR PCB
P	CONNECTOR, UTILITY VOL. SENSING PCB
R	RESISTOR, TIME DELAY NEUTRAL (TDN)
S	CONNECTOR, UTILITY VOL. SENSING PCB
SW1	SWITCH, MAINTENANCE DISCONNECT
SW2	SWITCH, SYSTEM TEST
SW3	SWITCH, TDN ON/OFF
TD	RELAY, TIME DELAY
TR	RELAY, TRANSFER
TR1	TRANSFORMER, STANDBY SENSING
TR2	TRANSFORMER, LOAD POWER SUPPLY
TR3	TRANSFORMER, UTILITY SENSING
TS1	TERMINAL STRIP
TS2	TERMINAL STRIP, 2 WIRE START

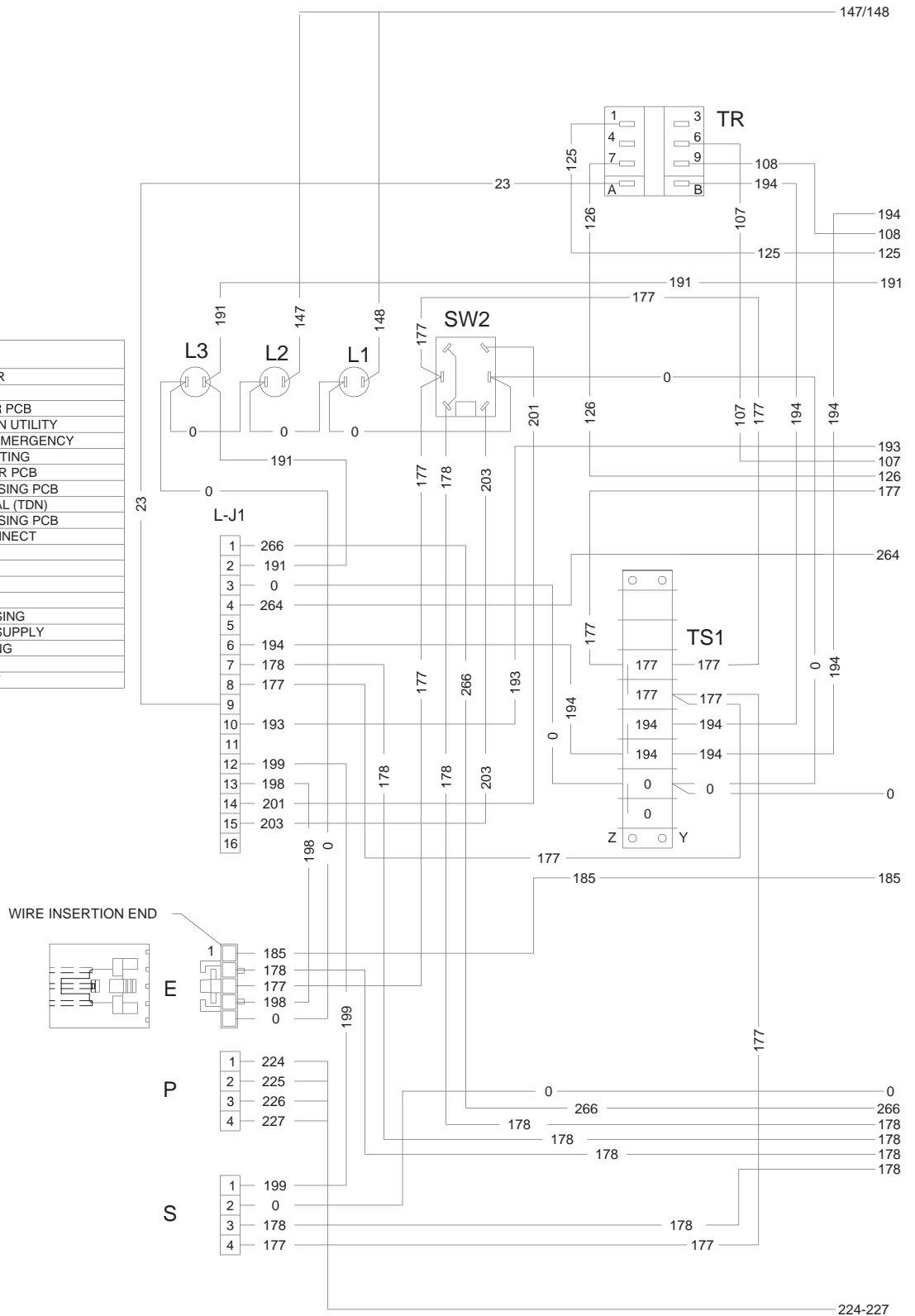

Section 6 – Wiring Diagrams & Electrical Schematics

Wiring Diagram - 480/600V – Drawing No. OD8113-A

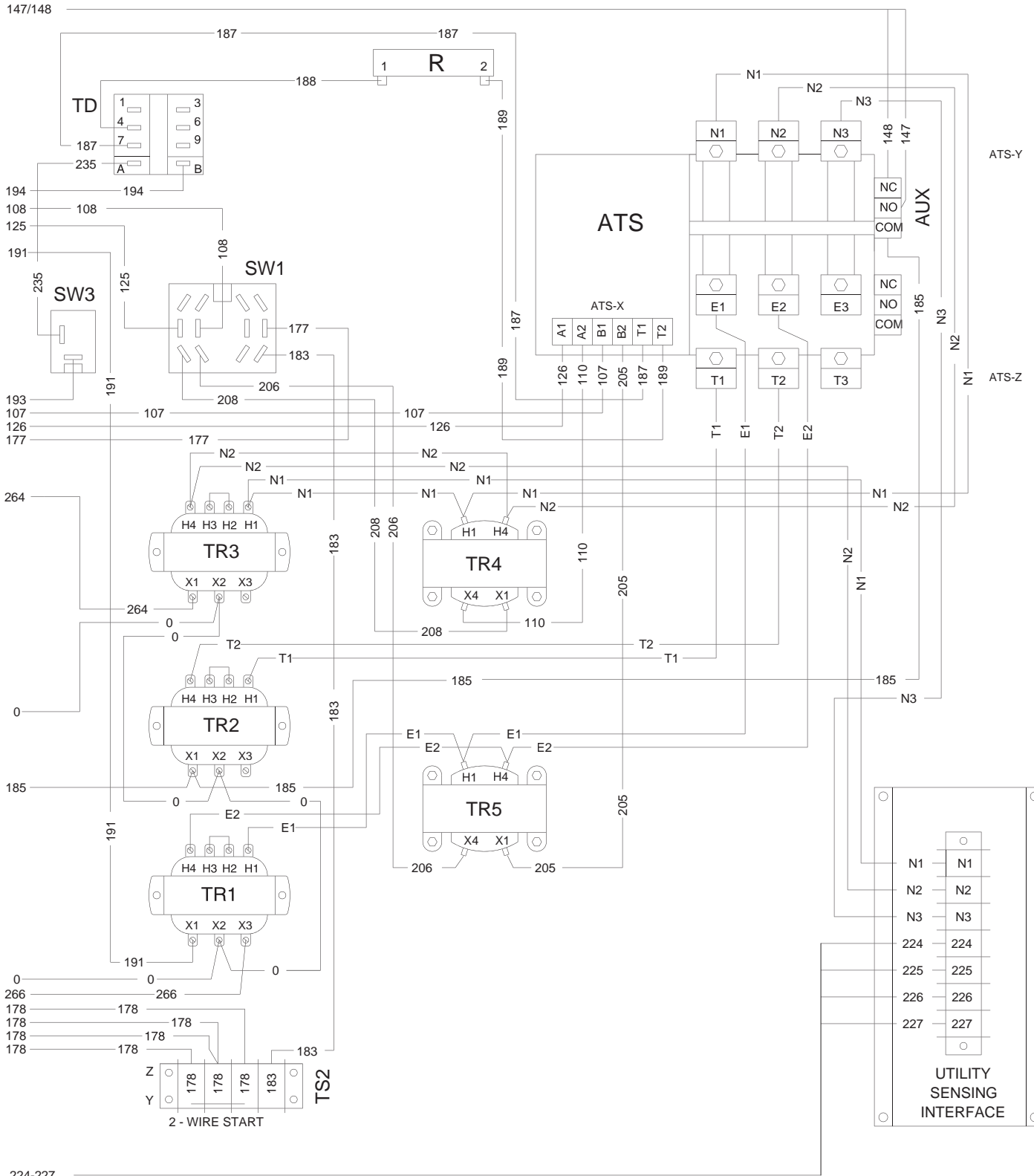
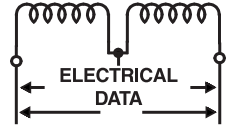

224-227



Section 6 – Wiring Diagrams & Electrical Schematics

Electrical Schematic - 480/600V – Drawing No. 0D8117-B

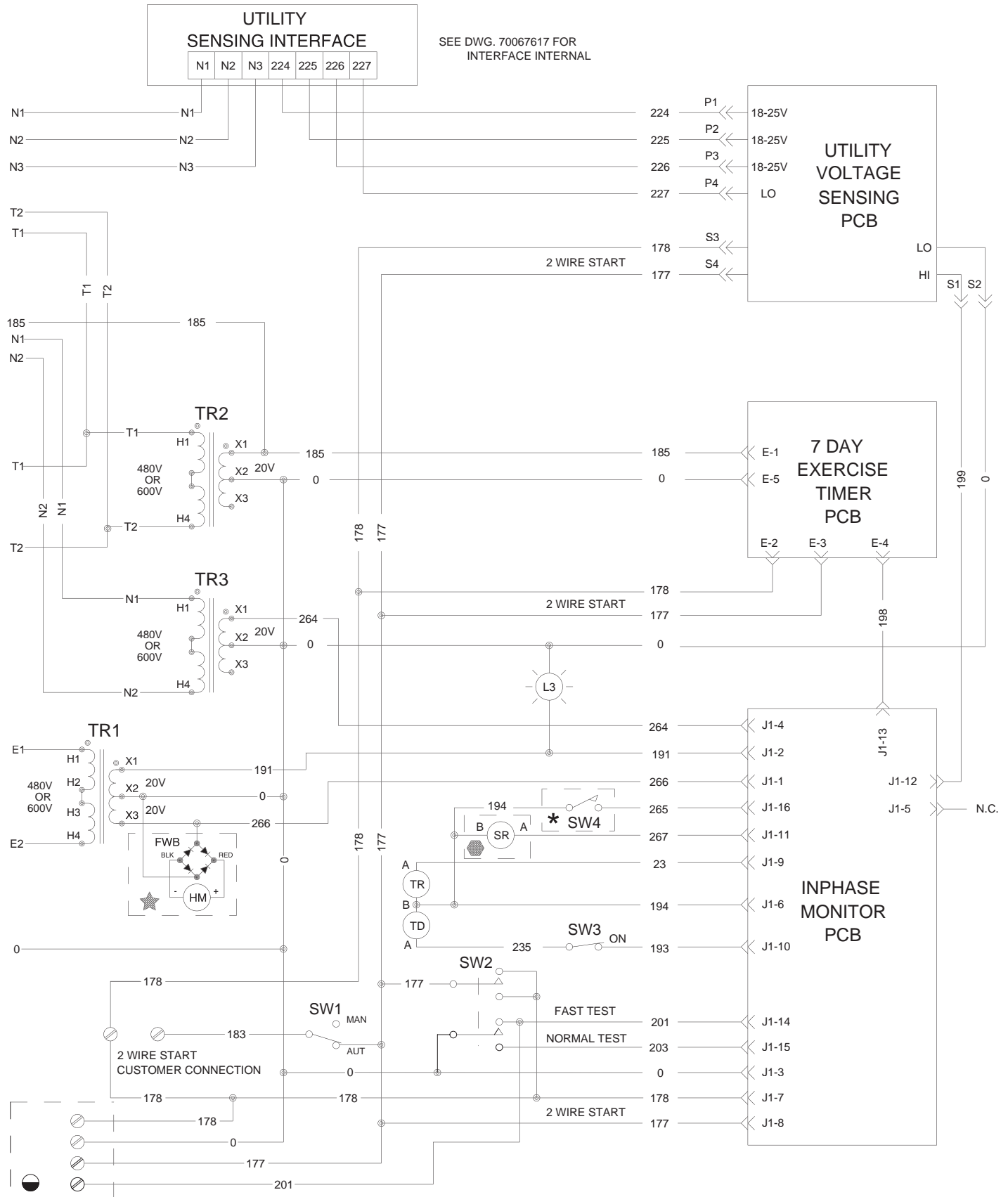
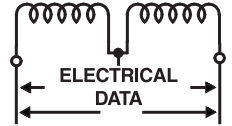





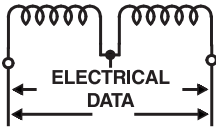

## Section 6 – Wiring Diagrams & Electrical Schematics

### Electrical Schematic – Drawing No. 0D4520

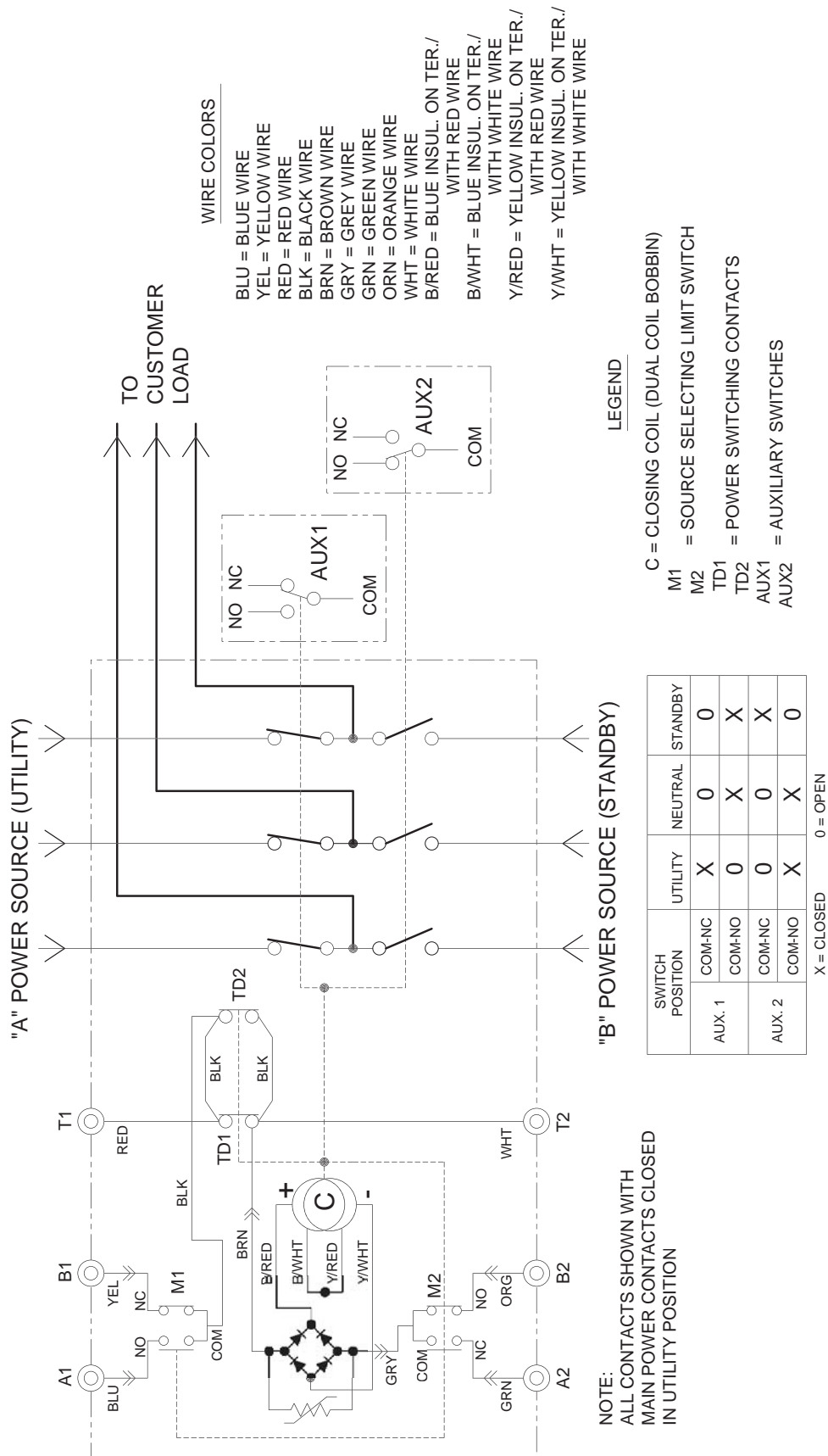

Section 6 – Wiring Diagrams & Electrical Schematics

Electrical Schematic/Interface – Drawing No. 70067617-B

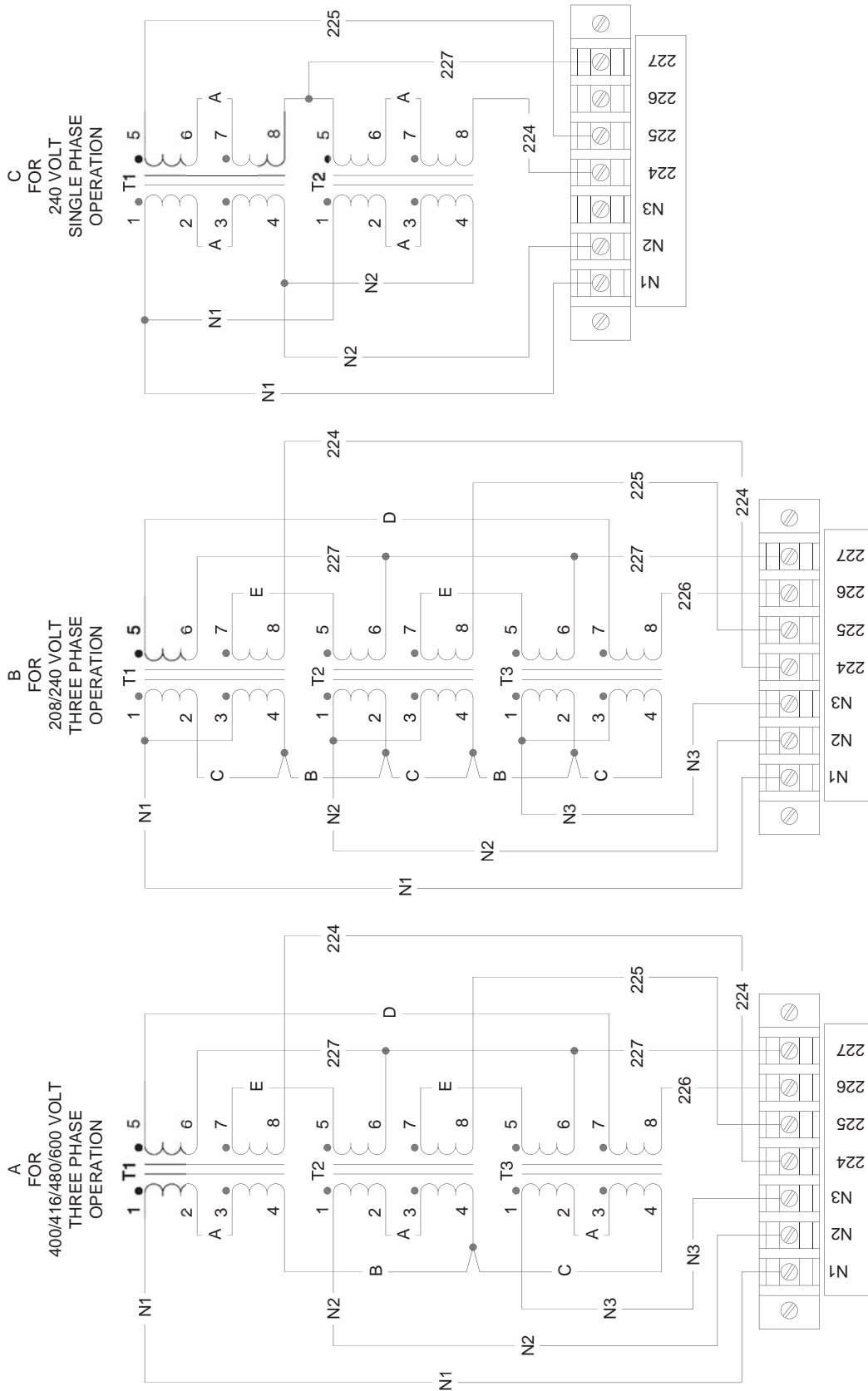
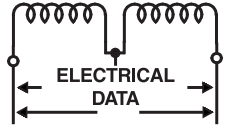

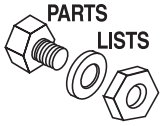

# Section 7 – Exploded Views & Parts Lists

## 100 Amp Assembly – Drawing No. 0D7651\$-E - Part 1

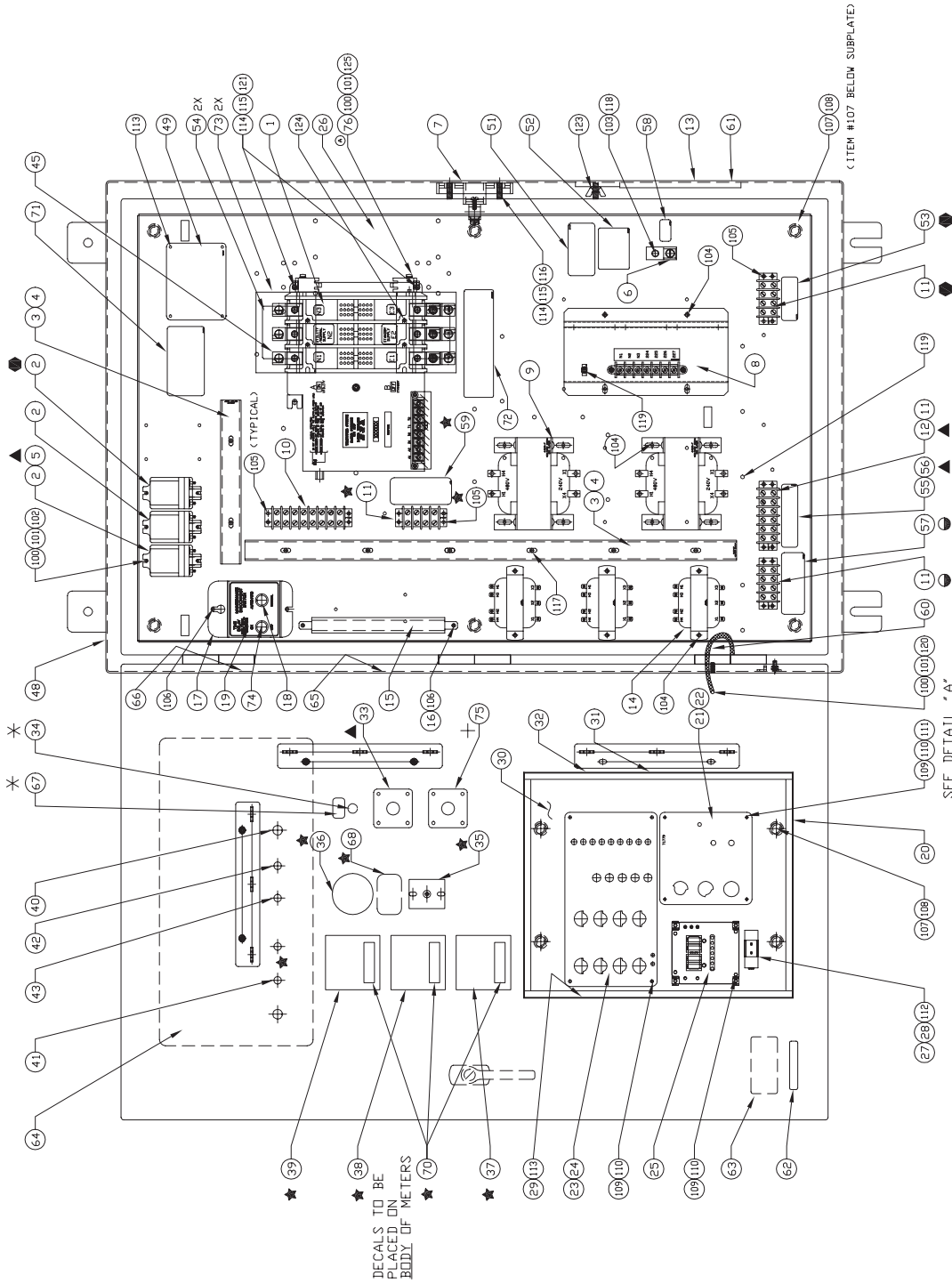

- LEGEND**
- INSTRUMENT PACKAGE
  - RETURN TO NORMAL BYPASS
  - PREFERRED SOURCE SELECTOR (USE 3-POLE RELAY AND 6-POLE TERMINAL STRIP)
  - REMOTE AUTO CONTROL
  - SIGNAL BEFORE TRANSFER
  - AUTO/NORMAL/STANDBY SELECTOR

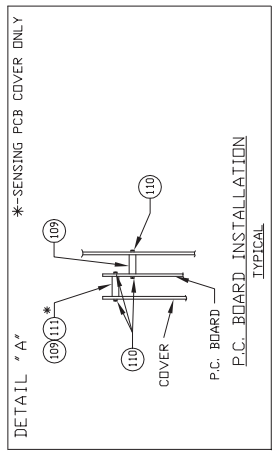

## Section 7 – Exploded Views & Parts Lists

### 100 Amp Assembly – Drawing No. 0D7651\$-E - Part 1

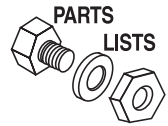

ITEM	PART NO.	QTY.	DESCRIPTION	ITEM	PART NO.	QTY.	DESCRIPTION
1	0D7300	1	XFER SW-W 100A600V2P		0C3472B	1	ENCL-NEM4X 1-150A
	0D7301	1	XFER SW-W 100A600V3P	49	063578	1	PLATE DATA - OEM
	0D7302	1	XFER SW-W 100A600V4P		0E5495	1	PLATE DATA - PRIVATE LABEL
2●	063617	REF	RELAY PNL 12VDC DPDT 10A@240VA	50	064153A	REF	WIRE-XFMR JUMPER (NOT SHOWN)
3	091472A	REF	COVER WIRE DUCT 1 IN	51	083736	1	DECAL-CSA GTS
4	091472	REF	DUCT WIRING 1 X 1.5 6 FT	52	062209	1	DECAL UL LABEL E84929-GTS
5▲	057334	REF	RELAY PNL 12VDC 3PDT 10A FL MT	53●	075355	1	DECAL-SGNL BFR XFER
6	062684	1	LUG SLDLSS 2/0-#12 X 11/32 CU	54	0C8308	2	DECAL TERMINAL SHOCK HAZARD
7	0C4449	1	ASSY NEUTRAL BLOCK 100A	55	091466	1	DECAL 2 WR TERM STRP
8	072158	1	INTRFC 3PHS 600V	56▲	098876	1	DECAL DUAL START
	072160	1	INTRFC 3P 400V 50/60	57●	074571	1	DECAL-REM. AUTO CNTR
	067617030A	1	INTRFC 3PHS 416/480V	58	067210A	1	DECAL GROUND LUG
	067617030B	1	INTRFC 3PHS 208/240V	59★	064114	1	DECAL-CUST CONN CTS
	086961	1	INTRFC 1PH 240V	60	0536210193	1	GND WIRE-ENCLSR DOOR
9	072162	2	TRANSFRM 600V TO 240V 200VA	61	0D4545	1	DECAL MANUAL OPERATION
	064126	2	TRANSFRM 240/480V-120/240V	62	077228	1	DECAL-ENCLOSURE NOTE
10	057701	1	BLOCK TERM 20A 8 X 6 X 1100V	63	095282	1	DECAL-LIVE CIRCUIT
11★●	046689	REF	BLOCK TERM 20A 4 X 6 X 1100V	64	0C2864	1	ENC DEC-OEM XFER SW
12▲	046357	REF	BLOCK TERM 20A 6 X 6 X 1100V		0C8135	1	DECAL-OEM DR-IN-DR
13	063321	1	HANDLE XFER SWITCH 1-400A		0E5374	1	DECAL ENCLOSURE PRIVATE LABEL
14	090975	3	XFMR 240/40V 25VA		0E5371	1	DECAL DOOR IN DOOR PRIVATE LABEL
	095394	3	XFRMR 600/40V 25VA	65	063385A	1	SWITCH INFO DECAL
15	063971	1	RES 250R 5% 100W	66	073619B	1	DECAL-TEST SEQ 100WN
16	063324	2	RES MTG BRACKET FOR 100W		095089H	1	DECAL 600V100A W/WN
17	074509	1	BRACKET SWITCH	67*	075369	1	DECAL-RET NML BYPASS
18	055868	1	SWITCH TOGGLE 4PDT 15A SPADE	68★	0C2603	1	DECAL PH SELECT A/V
19	074511	1	DECAL-TDN,MAINT. SW.	69★	0E1301	14	COVER PHASE SELECTOR SW
20	0C1652	1	ENCLOSURE-PCB	70★	0C4895	4	DECAL SHOCK HAZARD
21	067616020A	1	ASSY-STNDSNS CVRPLT	71	054199	1	DECAL HIGH VOLTAGE
22	067629	1	ASSY STANDARD SENSNG	72	064510	1	DECAL-TERMINAL NOTE
23	092734	1	ASSY INPHASE MONITOR	73	0C7907A	2	LUG COVER 2P 100AMP
24	094200A	1	ASSY-INPH COVER PLATE		0C7907B	2	COVER LUG 3P 100AMP
25	0A8637	1	ASSY MK3 EXERCISER		0C7907C	2	COVER LUG 4P 100AMP
	064217	1	ASSY 7-DAY EXERCISER (NOT SHOWN)	74	028199	1	SWITCH TOGGLE SPST 6A TAB C-H
26	0C3593	1	SBPL100A W/Y/C-XFRSW	75+	074614	1	SW 3 POS NRM/ATO/STB
27	063982	1	CLIP BATT-9V TRANSIS	76	074604	1	AUX CNTCT N-TYP SPDT
28	063998	1	BATTERY 9V	77	0E2651	1	CABLE, DLX-STD INTERFACE (NOT SHOWN)
29	0C1720	1	SD GUIDE-NEW PCB ENC	78	063996	1	ASSY, COVER STANDARD EXERCISER (NOT SHOWN)
30	0C1721	1	DOOR, NEW PCB ENC				
31	038057	1	GROMMET 7/8 X 1/16 X 3/4	100	038150	REF	WASHER FLAT #8 ZINC
32	072252	1	GROMMET 1.37 X .06 X 1.00	101	022264	REF	WASHER LOCK #8-M4
33▲		1	SW 2POS SOURCE SELCT	102	0A2284	REF	SCREW SWAGE 8-32 X 1/2 Z/YC
34*	072827	1	SWITCH TOG SPST 6A@125V SP MOM	103	024526	1	SCREW HHTT 5/16-18 X 3/4 CZ
35★	061945	1	SWITCH SELECTOR 6A AMP/V	104	056893	REF	SCREW CRIMP TITE 10-24 X 1/2
36★	070081	1	HOURMETER	105	0A1661	REF	RIVET POP .156 X .160-.164/#20
37★	070045	1	AMMETER AC 0-200	106	0A2111	4	SCREW SWAGE 10-32 X 5/16 Z/YC
38★	070042	1	FREQUENCY METER 240V 55-65HZ	107	022131	10	WASHER FLAT 3/8-M10 ZINC
39★	070043	1	VOLTMETER AC 0-300	108	064101	10	NUT LOCK FL 3/8-16
	070044	1	VOLTMETER AC 0-600	109	064525	16	STANDOFF HEX 3/4
40	055142	1	SWITCH TOG DPDT 15A MOM W/SEAL	110	064526	40	SCREW TAP HWH #6-25 X 3/8 ZINC
41	0C2163C	1	LED YEL WITH HOLDER	111	068337	4	STANDOFF-HEX 1.00 LG
42	0C2163A	1	LED GRN WITH HOLDER	112	0D7505	2	RIVET POP .094 X .250 BLND AL
43	0C2163B	1	LED RED WITH HOLDER	113	036261	8	RIVET POP .125 X .129-.133/#30
44	074604	REF	AUX CNTCT N-TYP SPDT	114	022473	REF	WASHER FLAT 1/4 ZINC
	074672A	REF	LMT SW-WN SEL & AUX2PL	115	022097	REF	WASHER LOCK M6-1/4
45	099084	REF	LUG SLDLSS 2/0-#6 X 21/64 AL/CU	116	022127	2	NUT HEX 1/4-20 STEEL
46★	064117	REF	TRANSFRM 200A TO 5A 4VA (NOT SHOWN)	117	091477	8	RIVET, WIRE DUCT MNT
47	0D8001	REF	WRG HARN-GTS 100A (NOT SHOWN)	118	027482	1	WASHER SHAKEPROOF EXT 5/16 STL
48	0C3468	1	ENCL-NEM1 1-150A	119	063378	13	HOLDER CABLE TIE
	0C3468A	1	ENL W/IN-NEM1 1-150A	120	028430	2	NUT HEX #10-24 STEEL
	0C3470	1	ENC W/IN-NEM12 100A CTTS	121	074906	3	SCREW HHTT M6-1.0 X 20 BP
	0C3470A	1	ENCL-NEM12 100A CTTS	122	023897	2	WASHER FLAT #10 ZINC
	0C3471A	1	ENC W/IN-NEM3R 1-150	123	025870	1	NUT WING 1/4-20
	0C3471	1	ENCL-NEM3R 1-150A	124	0C8275	4	SCREW PPHM DSEMS M4-7 X 10 ZNC
	0C3472A	1	ENC W/IN-NEM4 1-150A	125	092980	1	SCREW PPHM M4-0.7 X 25
48	0C3472	1	ENCL-NEM4 1-150A	126	022152	2	WASHER LOCK #10
	0C3472C	1	ENL W/IN-NEM4X 1-150				

**Section 7 – Exploded Views & Parts Lists**

**150/200A Low Voltage Assembly – Drawing No. 0D7651\$-E - Part 2**

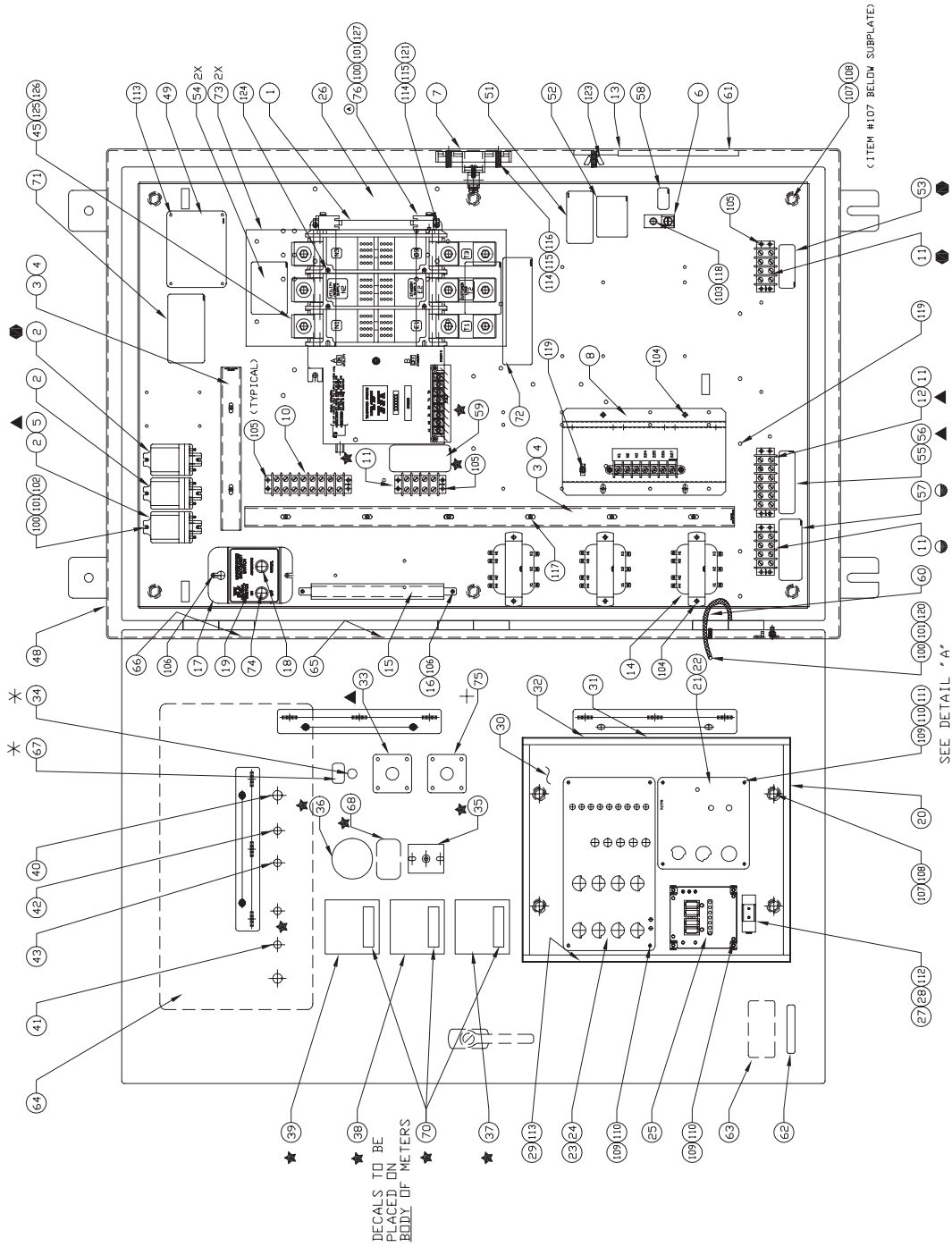

- LEGEND**
- INSTRUMENT PACKAGE
  - RETURN TO NORMAL BYPASS
  - PREFERRED SOURCE SELECTOR
  - USE, 3-POLE RELAY AND
  - SINGLE TERMINAL TRIP)
  - REMOTE AUTO CONTROL
  - SIGNAL BEFORE TRANSFER
  - AUTO/NORMAL/STANDBY SELECTOR
- ★ ▲ ● ⊕

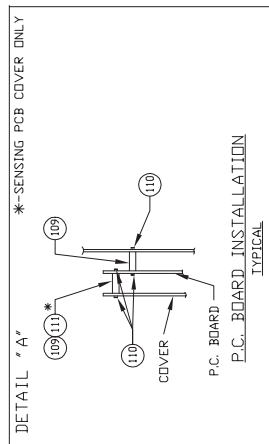

## Section 7 – Exploded Views & Parts Lists

### 150/200A Low Voltage Assembly – Drawing No. 0D7651\$-E - Part 2

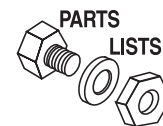

ITEM	PART NO.	QTY.	DESCRIPTION	ITEM	PART NO.	QTY.	DESCRIPTION
1	0C8881	1	XFER SW-W 150A600V2P	50	064153A	REF	WIRE-XFMR JUMPER (NOT SHOWN)
	0C8882	1	XFER SW-W 150A600V3P	51	083736	1	DECAL-CSA GTS
	0C8883	1	XFER SW-W 150A600V4P	52	062209	1	DECAL UL LABEL E84929-GTS
	0C8884		XFER SW-W 200A600V2P	53●	075355	1	DECAL-SGNL BFR XFER
	0C8885		XFER SW-W 200A600V3P	54	0C8308	2	DECAL TERMINAL SHOCK HAZARD
	0C8886		XFER SW-W 200A600V4P	55	091466	1	DECAL 2 WR TERM STRP
2●	063617	REF	RELAY PNL 12VDC DPDT 10A@240VA	56▲	098876	1	DECAL, DUAL START
3	091472A	REF	COVER WIRE DUCT 1 IN	57●	074571	1	DECAL-REM. AUTO CNTR
4	091472	REF	DUCT WIRING 1 X 1.5 6 FT	58	067210A	1	DECAL GROUND LUG
5▲	057334	REF	RELAY PNL 12VDC 3PDT 10A FL MT	59★	064114	1	DECAL-CUST CONN CTS
6	062684	1	LUG SLDLSS 2/0-#12 X 11/32 CU	60	0536210193	1	GND WIRE-ENCLSR DOOR
7	0C4449A	1	ASSY NEUTRAL BLOCK 200A	61	0D4545	1	DECAL MANUAL OPERATION
8	067617030B	1	INTRFC 3PHS 208/240V	62	077228	1	DECAL-ENCLOSURE NOTE
	086961	1	INTRFC 1PH 240V	63	095282	1	DECAL-LIVE CIRCUIT
10	057701	1	BLOCK TERM 20A 8 X 6 X 1100V	64	0C2864	1	ENC DEC-OEM XFER SW
11★●●	046689	REF	BLOCK TERM 20A 4 X 6 X 1100V		0C8135	1	DECAL-OEM DR-IN-DR
12▲	046357	REF	BLOCK TERM 20A 6 X 6 X 1100V		0E5374	1	DECAL ENCLOSURE PRIVATE LABEL
13	063321	1	HANDLE XFER SWITCH 1-400A		0E5371	1	DEACL DOOR IN DOOR PRIVATE LABEL
14	090975	3	XFMR 240/40V 25VA	65	063385A	1	SWITCH INFO DECAL
15	063971	1	RES 250R 5% 100W	66	073619N	1	DECAL-TEST SEQ150AWN
16	063324	2	RES MTG BRACKET FOR 100W		095089C	1	DEC-TEST SEQ200AW/WN
17	074509	1	BRACKET SWITCH	67*	075369	1	DECAL-RET NML BYPASS
18	055868	1	SWITCH TOGGLE 4PDT 15A SPADE	68★	0C2603	1	DECAL PH SELECT A/V
19	074511	1	DECAL-TDN,MAINT. SW.	69★	0E1301	14	COVER PHASE SELECTOR SW
20	0C1652	1	ENCLOSURE-PCB	70	0C4895	4	DECAL SHOCK HAZARD
21	067616020A	1	ASSY-STNDSNS CVRPLT	71	054199	1	DECAL HIGH VOLTAGE
22	067629	1	ASSY STANDARD SENSNG	72	064510	1	DECAL-TERMINAL NOTE
23	092734	1	ASSY INPHASE MONITOR	73	0C7907H	2	LUG COV2P 150/200AMP
24	094200A	1	ASSY-INPH COVER PLATE		0C7907D	2	COVER LUG 3P 150/200AMP
25	0A8637	1	ASSY MK3 EXERCISER		0C7907E	2	COVER LUG 4P 150/200AMP
	064217	1	ASSY 7-DAY EXERCISER (NOT SHOWN)	74	028199	1	SWITCH TOGGLE SPST 6A TAB C-H
26	0C3593	1	SBPL100A W/Y/C-XFRSW	75	074614	1	SW 3 POS NRM/ATO/STB
27	063982	1	CLIP BATT-9V TRANSIS	76	074604	1	AUX CNTCT N-TYP SPDT
28	063998	1	BATTERY 9V	77	0E2651	1	CABLE, DLX-STD INTERFACE (NOT SHOWN)
29	0C1720	1	SD GUIDE-NEW PCB ENC	78	063996	1	ASSY, COVER STANDARD EXERCISER (NOT SHOWN)
30	0C1721	1	DOOR, NEW PCB ENC				
31	038057	1	GROMMET 7/8 X 1/16 X 3/4	100	038150	REF	WASHER FLAT #8 ZINC
32	072252	1	GROMMET 1.37 X .06 X 1.00	101	022264	REF	WASHER LOCK #8-M4
33▲	074613	1	SW 2POS SOURCE SELCT	102	0A2284	REF	SCREW SWAGE 8-32 X 1/2 Z/YC
34*	072827	1	SWITCH TOG SPST 6A@125V SP MOM	103	024526	1	SCREW HHTT 5/16-18 X 3/4 CZ
35★	061945	1	SWITCH SELECTOR 6A AMP/V	104	056893	REF	SCREW CRIMP TITE 10-24 X 1/2
36★	070081	1	HOURMETER	105	0A1661	REF	RIVET POP .156 X .160-.164/#20
37★	070057	1	AMMETER AC 0-300	106	0A2111	4	SCREW SWAGE 10-32 X 5/16 Z/YC
38★	070042	1	FREQUENCY METER 240V 55-65HZ	107	022131	10	WASHER FLAT 3/8-M10 ZINC
39★	070043	1	VOLTMETER AC 0-300	108	064101	10	NUT LOCK FL 3/8-16
40	055142	1	SWITCH TOG DPDT 15A MOM W/SEAL	109	064525	16	STANDOFF HEX 3/4
41	0C2163C	1	LED YEL WITH HOLDER	110	064526	40	SCREW TAP HWH #6-25 X 3/8 ZINC
42	0C2163A	1	LED GRN WITH HOLDER	111	068337	4	STANDOFF-HEX 1.00 LG
43	0C2163B	1	LED RED WITH HOLDER	112	0D7505	2	RIVET POP .094 X .250 BLND AL
44	074604	REF	AUX CNTCT N-TYP SPDT	113	036261	8	RIVET POP .125 X .129-.133/#30
	074672A	REF	LMT SW-WN SEL& AUX2PL	114	022473	REF	WASHER FLAT 1/4 ZINC
45	0A9949	REF	LUG SLDLSS 400-#4 X1/4-20 CU7AL	115	022097	REF	WASHER LOCK M6-1/4
46★	064118	REF	TRANSFRM 300A TO 5A 7.5VA (NOT SHOWN)	116	022127	2	NUT HEX 1/4-20 STEEL
47	0D8001	REF	WRG HARN-GTS 100A (NOT SHOWN)	117	091477	8	RIVET WIRE DUCT MNT
48	0C3468	1	ENCL-NEM1 1-150A	118	027482	1	WASHER SHAKEPROOF EXT 5/16 STL
	0C3468A	1	ENL W/IN-NEM1 1-150A	119	063378	13	HOLDER CABLE TIE
	0C3470	1	ENC W/IN-NEM12 100A CTTS	120	028430	2	NUT HEX #10-24 STEEL
	0C3470A	1	ENCL-NEM12 100A CTTS	121	074906	3	SCREW HHTT M6-1.0 X 20 BP
	0C3471A	1	ENC W/IN-NEM3R 1-150	122	023897	2	WASHER FLAT #10 ZINC
	0C3471	1	ENCL-NEM3R 1-150A	123	025870	1	NUT WING 1/4-20
	0C3472A	1	ENC W/IN-NEM4 1-150A	124	0C8275	4	SCREW PPHM DSEMS M4-7 X 10 ZNC
48	0C3472	1	ENCL-NEM4 1-150A	125	0C4896	REF	SCREW FHM M8-1.25 X 20MM CR
	0C3472C	1	ENL W/IN-NEM4X 1-150	126	067989	REF	NUT LOCK FL M8-1.25 YEL CHR
48	0C3472B	1	ENCL-NEM4X 1-150A	127	092980	1	SCREW PPHM M4-0.7 X 25
49	063578	1	PLATE DATA - OEM	128	022152	2	WASHER LOCK #10
	0E5495	1	PLATE DATA - PRIVATE LABEL				



## Section 7 – Exploded Views & Parts Lists

### 150/400A High Voltage Assembly – Drawing No. OD7651\$-E - Part 3

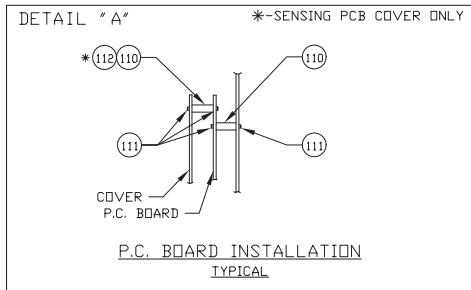
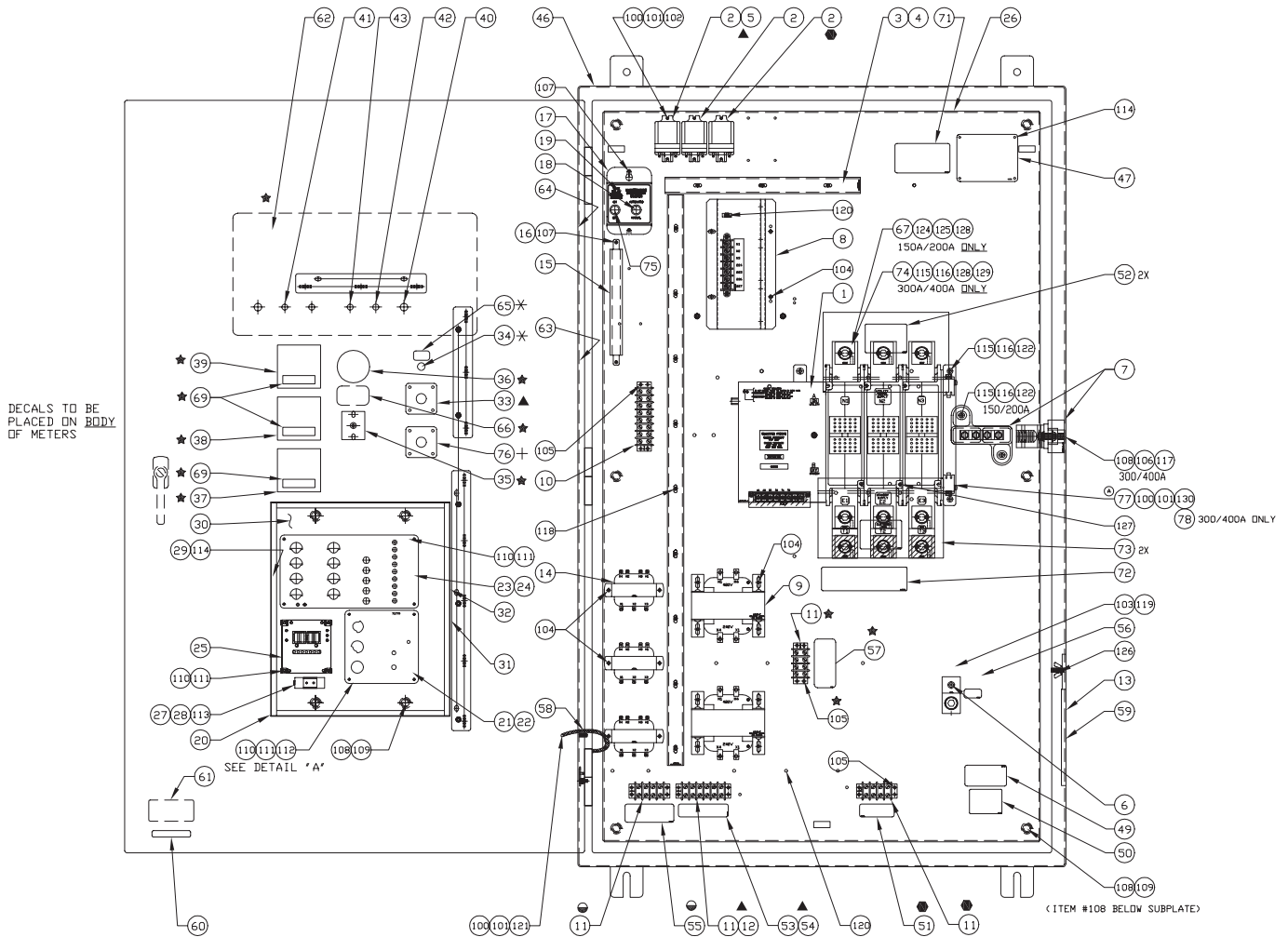

#### LEGEND

- ★ - INSTRUMENT PACKAGE
- \* - RETURN TO NORMAL BYPASS
- ▲ - PREFERRED SOURCE SELECTOR (USE 3-POLE RELAY AND 6-POLE TERMINAL STRIP)
- - REMOTE AUTO CONTROL
- - SIGNAL BEFORE TRANSFER
- ⊕ - AUTO/NORMAL/STANDBY

ITEM	PART NO.	QTY.	DESCRIPTION
1	OC8881	1	XFER SW-W 150A600V2P
	OC8882	1	XFER SW-W 150A600V3P
	OC8883	1	XFER SW-W 150A600V4P
	OC8884	1	XFER SW-W 200A600V2P
	OC8885	1	XFER SW-W 200A600V3P
	OC8886	1	XFER SW-W 200A600V4P
	OD7297	1	XFER SW-W 300A600V2P
	OD7298	1	XFER SW-W 300A600V3P
	OD7299	1	XFER SW-W 300A600V4P
	OD7294	1	XFER SW-W 400A600V2P
	OD7295	1	XFER SW-W 400A600V3P
	OD7296	1	XFER SW-W 400A600V4P

ITEM	PART NO.	QTY.	DESCRIPTION
2●	063617	REF	RELAY PNL 12VDC DPDT 10A@240VA
3	091472A	REF	COVER WIRE DUCT 1 IN
4	091472	REF	DUCT WIRING 1X1.5 6 FT
5▲	057334	REF	RELAY PNL 12VDC 3PDT 10A FL MT
6	057329	1	LUG SLDLSS 350-#6X13/32 AL/CU
7	OC4449A	1	ASSY NEUTRAL BLOCK 200A
	OC2162	1	ASSY NEUTRAL BLOCK 300-400A
8	072158	1	INTRFC,3PHS 600V
	072160	1	INTRFC,3P 400V 50/60
	067617030A	1	INTRFC,3PHS 416/480V
	067617030B	1	INTRFC,3PHS 208/240V
	086961	1	INTRFC,1PH 240V

## Section 7 – Exploded Views & Parts Lists

### 150/400A High Voltage Assembly – Drawing No. 0D7651\$-E - Part 3

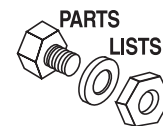

ITEM	PART NO.	QTY.	DESCRIPTION	ITEM	PART NO.	QTY.	DESCRIPTION
9	072162	2	TRANSFRM 600V TO 240V 200VA	OC8135	1	DECAL-OEM DR-IN-DR	
	064126	2	TRANSFRM 240/480V-120/240V	0E5371	1	DECAL-DOOR IN DOOR PRIVATE LABEL	
10	057701	1	BLOCK TERM 20A 8 X 6 X 1100V	0E5374	1	DECAL-ENCLOSURE PRIVATE LABEL	
11★●	046689	REF	BLOCK TERM 20A 4 X 6 X 1100V	63	063385A	1	SWITCH INFO DECAL
12★	046357	REF	BLOCK TERM 20A 6 X 6 X 1100V	64	073619N	1	DECAL-TEST SEQ150AWN
13▲	063321	1	HANDLE XFER SWITCH 1-400A		073619C	1	DEC-TEST SEQ200AW/WN
14	090975	3	XFMR 240/40V 25VA		073619P	1	DECAL-TEST SEQ 300 W
	095394	3	XFRMR 600/40V 25VA		073619R	1	DECAL-TEST SEQ 400 W
15	063971	1	RES 250R 5% 100W		073619J	1	DECAL-TEST SEQ1200WN
16	063324	2	RES MTG BRACKET FOR 100W		073619K	1	DECAL-TEST SEQ1600WN
17	074509	1	BRACKET SWITCH		073619L	1	DECAL-TEST SEQ2000WN
18	055868	1	SWITCH TOGGLE 4PDT 15A SPADE	65*	075369	1	DECAL-RET NML BYPASS
19	074511	1	DECAL-TDN,MAINT. SW.	66★	0C2603	1	DECAL PH SELECT A/V
20	0C1652	1	ENCLOSURE-PCB	67	0A9949	1	LUG SLDLSS 400-#4X1/4-20 CU7AL
21	067616020A	1	ASSY-STNDSNS CVRPLT	68★	0E1301	14	COVER PHASE SELECTOR SW
22	067629	1	ASSY STANDARD SENSNG	69★	0C4895	4	DECAL SHOCK HAZARD
23	092734	1	ASSY INPHASE MONITOR	70★	064118	REF	TRNFR 300A TO 5A 7.5VA (200A ONLY)
24	094200A	1	ASSY-INPH COVER PLATE				(NOT SHOWN)
25	0A8637	1	ASSY MK3 EXERCISER	★	064119	REF	TRNFR 400A TO 5A 10VA (300A ONLY)
	064217	1	ASSY 7-DAY EXERCISER (NOT SHOWN)	★	064120	REF	TRNFR 600A TO 5A 15VA (400A ONLY)
26	0C3938	1	SBPL15-400A W/Y/C-SW				(NOT SHOWN)
27	063982	1	CLIP BATT-9V TRANSIS	71	054199	1	DECAL HIGH VOLTAGE
28	063998	1	BATTERY 9V	72	064510	1	DECAL-TERMINAL NOTE
29	0C1720	2	SD GUIDE-NEW PCB ENC	73	0C7907H	2	LUG COV2P 150/200AMP
30	0C1721	1	DOOR, NEW PCB ENC		0C7907D	2	COVER LUG 3P 150/200AMP
31	038057	1	GROMMET 7/8 X 1/16 X 3/4		0C7907E	2	COVER LUG 4P 150/200AMP
32	072252	1	GROMMET 1.37 X .06 X 1.00		0C7907J	2	COVER LUG 2P 300/400AMP
33▲	074613	1	SW 2POS SOURCE SELCT		0C7907F	2	COVER LUG 3P 300/400AMP
34*	072827	1	SWITCH TOG SPST 6A@125V SP MOM		0C7907G	2	COVER LUG 4P 300/400AMP
35★	061945	1	SWITCH SELECTOR 6A AMP/V	74	0A7822	REF	LUG SLDLSS 600/250-1/0X1/4-28
36★	070081	1	HOURMETER	75	028199	1	SWITCH TOGGLE SPST 6A TAB C-H
37★	070057	1	AMMETER AC 0-300 (200A ONLY)	76+	074614	1	SW 3 POS NRM/ATO/STB
★	070058	1	AMMETER AC 0-400 (300A ONLY)	77	074604	1	AUX CNTCT N-TYP SPDT
★	070059	1	AMMETER AC 0-600 (400A ONLY)	78	092979	1	AUX CONT INSULATOR
38★	070042	1	FREQUENCY METER 240V 55-65HZ	79	0E2651	1	CABLE, DLX-STD INTERFACE (NOT SHOWN)
39★	070043	1	VOLTMETER AC 0-300	80	063996	1	ASSY, COVER STANDARD EXERCISER
★	070044	1	VOLTMETER AC 0-600				(NOT SHOWN)
40	055142	1	SWITCH TOG DPDT 15A MOM W/SEAL	100	038150	REF	WASHER FLAT #8 ZINC
41	0C2163C	1	LED YEL WITH HOLDER	101	022264	REF	WASHER LOCK #8-M4
42	0C2163A	1	LED GRN WITH HOLDER	102	0A2284	REF	SCREW SWAGE 8-32 X 1/2 Z/YC
43	0C2163B	1	LED RED WITH HOLDER	103	024526	1	SCREW HHTT 5/16-18 X 3/4 CZ
44	074604	REF	AUX CNTCT N-TYP SPDT	104	056893	REF	SCREW CRIMP TITE 10-24 X 1/2
	074672A	REF	LMT SW-WN SEL&AUX2PL	105	0A1661	REF	RIVET POP .156 X .160-.164/#20
45	0D8002	1	WRG HARN-GTS 150A-400A (NOT SHOWN)	106	022237	2	WASHER LOCK 3/8
46	0C3474	1	ENCL-NEM1 15-400A	107	0A2111	4	SCREW SWAGE 10-32 X 5/16 Z/YC
	0C3474A	1	ENLW/IN-NEM1 15-400A	108	022131	REF	WASHER FLAT 3/8-M10 ZINC
	0C3475	1	ENLW/IN-NEM12 15-400	109	064101	10	NUT LOCK FL 3/8-16
	0C3475A	1	ENCL-NEM12 15-400A	110	064525	16	STANDOFF HEX 3/4
	0C3477A	1	ENLW/IN-NEM3R 15-400	111	064526	40	SCREW TAP HWH #6-25 X 3/8 ZINC
	0C3477	1	ENCL-NEMA,3R,GTS,150-400A	112	068337	4	STANDOFF-HEX 1.00 LG
	0C3478A	1	ENLW/IN-NEM4 15-400A	113	0D7505	2	RIVET POP .094 X .250 BLND AL
	0C3478	1	ENCL-NEM4 15-400A	114	036261	8	RIVET POP .125 X .129-.133/#30
	0C3478C	1	ENLW/IN-NEM4X 15-400	115	022473	REF	WASHER FLAT 1/4 ZINC
	0C3478B	1	ENCL-NEM4X 15-400A	116	022097	REF	WASHER LOCK M6-1/4
47	063578	1	PLATE DATA - OEM	117	022241	2	NUT HEX 3/8-16 STEEL
	0E5495	1	PLATE DATA - PRIVATE LABEL	118	091477	13	RIVET WIRE DUCT MNT
48	064153A	REF	WIRE-XFMR JUMPER (NOT SHOWN)	119	027482	1	WASHER SHAKEPROOF EXT 5/16 STL
49	083736	1	DECAL-CSA GTS (OPTIONAL)	120	063378	15	HOLDER CABLE TIE
50	062209	1	DECAL UL LABEL E84929-GTS	121	022471	2	NUT HEX #8-32 STEEL
51●	075355	1	DECAL-SGNL BFR XFER	122	074906	REF	SCREW HHTT M6-1.0 X 20 BP
52	0C8308	2	DECAL TERMINAL SHOCK HAZARD	123	023897	2	WASHER FLAT #10 ZINC
53	091466	1	DECAL 2 WR TERM STRP	124	0C4896	REF	SCREW FHM M8-1.25 X 20MM CR
54▲	098876	1	DECAL, DUAL START	125	067989	2	NUT LOCK FL M8-1.25 YEL CHR
55●	074571	1	DECAL-REM. AUTO CNTR	126	025870	1	NUT WING 1/4-20
56	067210A	1	DECAL GROUND LUG	127	0C8275	4	SCREW PPHM DSEMS M4-7 X 10 ZNC
57★	064114	1	DECAL-CUST CONN CTS	128	026902	7	SCREW HHTT #8-32 X 1/4 CZ
58	0536210193	1	GND WIRE-ENCLSR DOOR	129	0A8261	REF	SCREW HHC 1/4-28 X 5/8 .625TH
59	0D4545	1	DECAL, MANUAL OPERATION	130	092980	2	SCREW PPHM M4-0.7 X 25
60	077228	1	DECAL-ENCLOSURE NOTE	131	022152	2	WASHER LOCK #10
61	095282	1	DECAL-LIVE CIRCUIT				
62	0C2864	1	ENC DEC-OEM XFER SW				

**Section 7 – Exploded Views & Parts Lists**

**300-400 Amp Low Voltage Assembly – Drawing No. 0E1718-B**

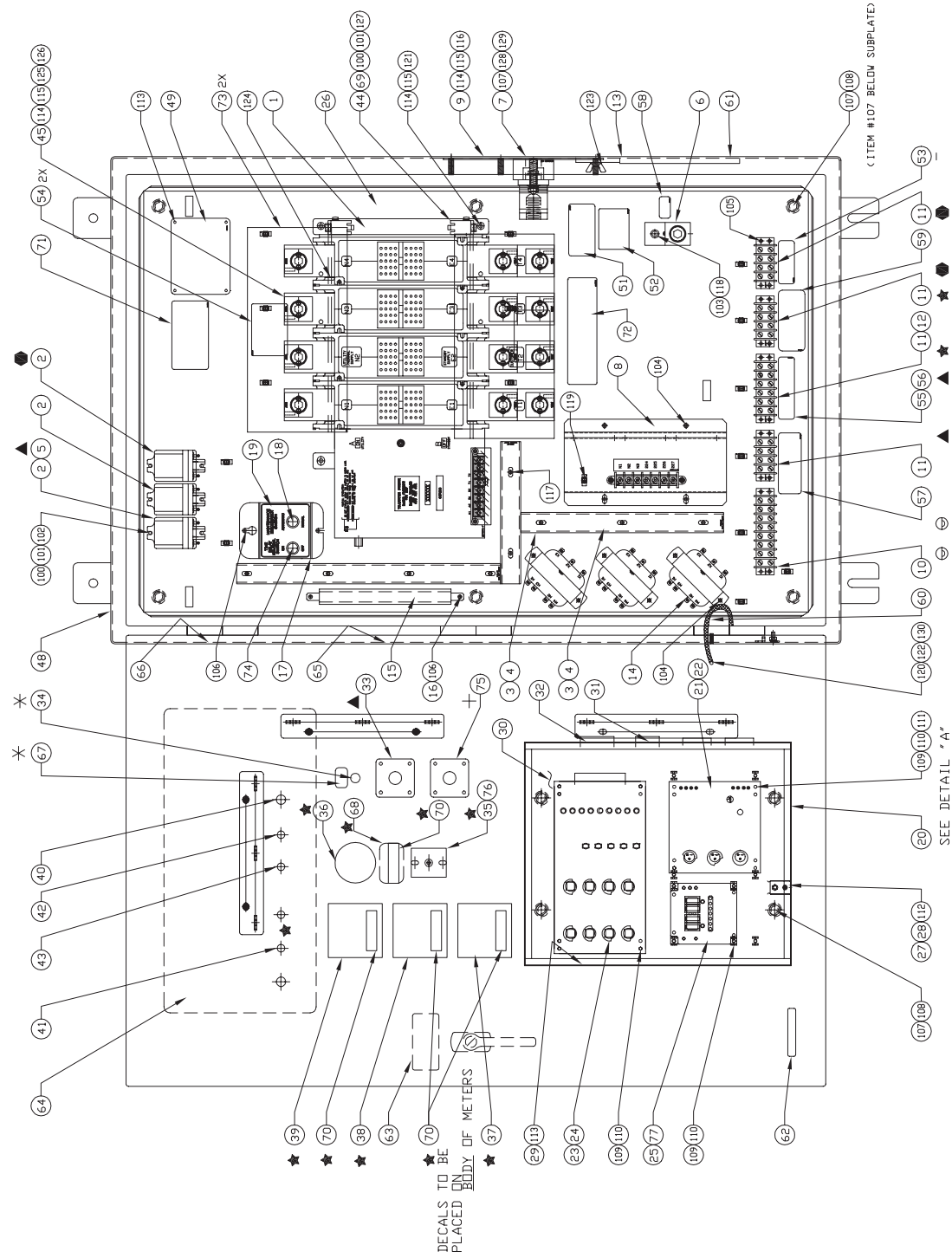

- LEGEND**
- INSTRUMENT PACKAGE
  - RETURN TO NORMAL BYPASS
  - PREFERRED SOURCE SELECTOR
  - COSE 3-POLE RELAY AND CHOLE TERMINAL STRIP
  - REMOTE AUTO. CONTROL
  - SIGNAL BEFORE TRANSFER
  - AUTO/NORMAL/STANDBY SELECTOR
- ★ \* ▲ ⊕ ⊖

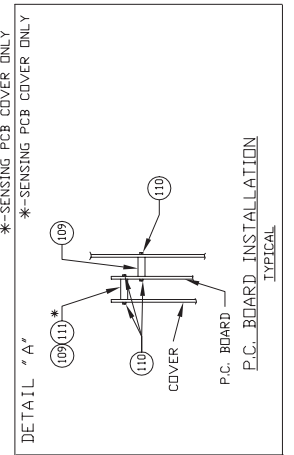

## Section 7 – Exploded Views & Parts Lists

**300-400 Amp Low Voltage Assembly – Drawing No. 0E1718-B**

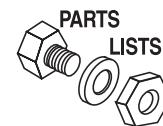

ITEM	PART NO.	QTY.	DESCRIPTION	ITEM	PART NO.	QTY.	DESCRIPTION
1	0D7297	1	XFER SW-W 300A600V2P	49	063578	1	PLATE DATA - OEM
	0D7298	1	XFER SW-W 300A600V3P		0E5495	1	DECAL DATA PRIVATE LABEL
	0D7299	1	XFER SW-W 300A600V4P	50	064153A	REF	WIRE-XFMR JUMPER (NOT SHOWN)
	0D7294	1	XFER SW-W 400A600V2P	51	083736	1	DECAL-CSA GTS
	0D7295	1	XFER SW-W 400A600V3P	52	062209	1	DECAL UL LABEL E84929-GTS
	0D7296	1	XFER SW-W 400A600V4P	53●	075355	1	DECAL-SGNL BFR XFER
2●	063617	REF	RELAY PNL 12VDC DPDT 10A@240VA	54	0C8308	2	DECAL TERMINAL SHOCK HAZARD
3	091472A	REF	COVER WIRE DUCT 1 IN	55	091466	1	DECAL 2 WR TERM STRP
4	091472	REF	DUCT WIRING 1X1.5 6 FT	56▲	098876	1	DECAL, DUAL START
5▲	057334	REF	RELAY PNL 12VDC 3PDT 10A FL MT	57●	074571	1	DECAL-REM. AUTO CNTR
6	057329	1	LUG SLDLSS 350-#6X13/32 AL/CU	58	067210A	1	DECAL GROUND LUG
7	0C2162	1	ASSY NEUTRAL BLOCK 300-400A	59★	064114	1	DECAL-CUST CONN CTS
8	067617030B	1	INTRFC,3PHS 208/240V	60	0536210193	1	GND WIRE-ENCLSR DOOR
	086961	1	INTRFC,1PH 240V	61	0D4545	1	DECAL, MANUAL OPERATION
9	0E1719	1	PLATE,NEUTRAL BLK MOUNTING	62	077228	1	DECAL-ENCLOSURE NOTE
10	057701	1	BLOCK TERM 20A 8 X 6 X 1100V	63	095282	1	DECAL-LIVE CIRCUIT
11●★●	046689	REF	BLOCK TERM 20A 4 X 6 X 1100V	64	0C2864	1	ENC DEC-OEM XFER SW
12▲	046357	REF	BLOCK TERM 20A 6 X 6 X 1100V		0C8135	1	DECAL-OEM DR-IN-DR
13	063321	1	HANDLE XFER SWITCH 1-400A		0C1897	1	DECAL-OEM PWR SYST
14	090975	3	XFMR 240/40V 25VA		0E5374	1	DECAL-ENCLOSURE PRIVATE LABEL
15	063971	1	RES 250R 5% 100W		0E5371	1	DECAL-DOOR IN DOOR PRIVATE LABEL
16	063324	2	RES MTG BRACKET FOR 100W		0E5372	1	DECAL- PRIVATE LABEL
17	074509	1	BRACKET SWITCH	65	063385A	1	SWITCH INFO DECAL
18	055868	1	SWITCH TOGGLE 4PDT 15A SPADE	66	073619P	1	DECAL-TEST SEQ 300 W
19	074511	1	DECAL TDN MAINTENANCE SW		073619R	1	DECAL-TEST SEQ 400 W
20	0C1652	1	ENCLOSURE-PCB, NEW	67*	075369	1	DECAL-RET NML BYPASS
21	067616020A	1	ASSY-STNDSNS CVRPLT	68★	0C2603	1	DECAL PH SELECT A/V
22	067629	1	ASSY STANDARD SENSNG	69	092979	1	AUX CONT INSULATOR
23	092734	1	ASSY INPHASE MONITOR	70★	0C4895	4	DECAL SHOCK HAZARD
24	094200A	1	ASSY-INPH COVR PLAT	71	054199	1	DECAL HIGH VOLTAGE
25	0A8637	1	ASSY MK3 EXERCISER	72	064510	1	DECAL-TERMINAL NOTE
	064217	1	ASSY 7-DAY EXERCISER	73	0C7907J	2	COVER LUG 2P 300/400AMP
26	0E1682	1	SUBPLATE GTS 400A W-SW		0C7907F	2	COVER LUG 3P 300/400AMP
27	063982	1	CLIP BATT-9V TRANSIS		0C7907G	2	COVER LUG 4P 300/400AMP
28	063998	1	BATTERY 9V	74	028199	1	SWITCH TOGGLE SPST 6A TAB C-H
29	0C1720	1	SD GUIDE-NEW PCB ENC	75	074614	1	SW 3 POS NRM/ATO/STB
30	0C1721	1	DOOR, NEW PCB ENC	76	0E1301	14	COVER, PHASE SELECTOR SW
31	038057	1	GROMMET 7/8 X 1/16 X 3/4	77	0E2651	1	CABLE, DLX-STD INTERFACE
32	072252	1	GROMMET 1.37 X .06 X 1.00	100	038150	REF	WASHER FLAT #8 ZINC
33▲	074613	1	SW 2POS SOURCE SELCT	101	022264	REF	WASHER LOCK #8-M4
34*	072827	1	SWITCH TOG SPST 6A@125V SP MOM	102	0A2284	REF	SCREW SWAGE 8-32 X 1/2 Z/YC
35★	061945	1	SWITCH SELECTOR 6A AMP/V	103	024526	1	SCREW HHTT 5/16-18 X 3/4 CZ
36★	070081	1	HOURMETER	104	056893	10	SCREW CRIMPTITE 10-24 X 1/2
37★	070058	1	AMMETER AC 0-400	105	0A1661	REF	RIVET POP .156 X .675 AL
	070059	1	AMMETER AC 0-600	106	0A2111	4	SCREW SWAGE 10-32 X 5/16 Z/YC
38★	070042	1	FREQUENCY METER 240V 55-65HZ	107	022131	REF	WASHER FLAT 3/8-M10 ZINC
39★	070043	1	VOLTMETER AC 0-300	108	064101	10	NUT LOCK FL 3/8-16
40	055142	1	SWITCH TOG DPDT 15A MOM W/SEAL	109	064525	16	STANDOFF HEX 3/4
41	0C2163C	1	LED YEL WITH HOLDER	110	064526	40	SCREW S-THR PH #6-25 X 3/8 ZNC
42	0C2163A	1	LED GRN WITH HOLDER	111	068337	4	STANDOFF-HEX 1.00 LG
43	0C2163B	1	LED RED WITH HOLDER	112	0D7505	2	RIVET POP .094 X .250 BLND AL
44	074604	REF	AUX CNTCT N-TYP SPDT	113+	036261	8	RIVET POP .125 X .275 AL
	074672A	REF	LMT SW-WN SEL&AUX2PL	114	022473	REF	WASHER FLAT 1/4-M6 ZINC
45	0A7822	REF	LUG SLDLSS 600/250-1/0X1/4-28	115	022097	REF	WASHER LOCK M6-1/4
46★	064119	REF	TRANSFRM 400A TO 5A 10VA (NOT SHOWN)	116	022127	2	NUT HEX 1/4-20 STEEL
				117	091477	11	RIVET, WIRE DUCT MNT
	064120	REF	TRANSFRM 600A TO 5A 15VA (NOT SHOWN)	118	027482	1	WASHER SHAKEPROOF EXT 5/16 STL
				119	063378	16	HOLDER CABLE TIE
47	0E1720A	REF	GTS 400A LV WRS-STNDRD (NOT SHOWN)	120	028430	2	NUT HEX #10-24 STEEL
48	0C3468	1	ENCL-NEM1 1-150A	121	074906	3	SCREW HHTT M6-1.0 X 20 BP
	0C3468A	1	ENCL W/IN-NEM1 1-150A	122	023897	2	WASHER FLAT #10 ZINC
	0C3470	1	ENC W/IN-NEM12 100A CTTS	123	025870	1	NUT WING 1/4-20
	0C3470A	1	ENCL-NEM12 100A CTTS	124	0C8275	4	SCREW PPHM DSEMS M4-7 X 10 ZNC
	0C3471A	1	ENCL W/IN-NEM3R 1-150	125	026902	REF	SCREW HHTT #8-32 X 1/4 CZ
	0C3471	1	ENCL-NEM3R 1-150A	126	0A8261	REF	SCREW HHC 1/4-28 X 5/8 .625TH
	0C3472A	1	ENC W/IN-NEM4 1-150A	127	092980	2	SCREW PPHM M4-0.7 X 25
	0C3472	1	ENCL-NEM4 1-150A	128	022237	2	WASHER LOCK 3/8
	0C3472C	1	ENL W/IN-NEM4X 1-150	129	022241	2	NUT HEX 3/8-16 STEEL
	0C3472B	1	ENCL-NEM4X 1-150A	130	022152	2	WASHER LOCK #10



## Section 8 – Warranty

### Generac GTS "W" Type Transfer Switch

#### GENERAC POWER SYSTEMS STANDARD TWO-YEAR LIMITED WARRANTY FOR GENERAC TRANSFER SWITCH SYSTEMS

**NOTE: ALL UNITS MUST HAVE A START-UP INSPECTION PERFORMED BY AN AUTHORIZED GENERAC DEALER.**

For a period of 2 (two) years from the date of sale/start date, Generac Power Systems, Inc. will, at its option, repair or replace any part(s) which, upon examination, inspection, and testing by Generac Power Systems or a Generac Power Systems Authorized Warranty Service Facility, is found to be defective under normal use and service, in accordance with the warranty schedule set forth below. Any equipment that the purchaser/owner claims to be defective must be returned to, and examined by the nearest Generac Power Systems Authorized Warranty Service Facility. All transportation costs under the warranty, including return to the factory, are to be borne and prepaid by the purchaser/owner. This warranty applies only to Generac Power Systems Transfer Switch applications, as Generac Power Systems, Inc. have defined Transfer Switch application, provided said Transfer Switch has been initially installed and inspected on-site by a Generac Power Systems Authorized Service Dealer or branch thereof. A scheduled maintenance agreement with a local Authorized Generac Power Systems Dealer is highly recommended to verify adequate service has been performed on the unit throughout the warranty period.

#### WARRANTY SCHEDULE

- **YEAR ONE** — 100% (one hundred percent) coverage on mileage\*, labor, and parts listed.
- **ALL COMPONENTS**
- **YEAR TWO** — 100% (one hundred percent) coverage on parts listed.
- **ALL COMPONENTS — \*PARTS ONLY**
- \*Travel allowance is limited to 300 miles maximum, or 7.5 hours maximum (per occurrence), **round trip**, to the nearest authorized Generac Service Facility.
- A Generac Power Systems, Inc. Transfer Switch is highly recommended to be used in conjunction with the genset. If a non Generac genset is substituted for use and directly causes damage to the Generac Transfer Switch, no warranty coverage shall apply.
- All warranty expense allowances **are** subject to the conditions defined in Generac Power Systems Warranty, Policies, and Procedures Flat Rate Manual.
- Units that have been resold **are not** covered under the Generac Power Systems Warranty, as this Warranty **is not** transferable.

**THIS WARRANTY SHALL NOT APPLY TO THE FOLLOWING:**

1. Any unit built/manufactured prior to January 1, 2002.
2. Unit enclosure is only covered against rust or corrosion the first year of the warranty provision.
3. Costs of normal maintenance i.e. tune-ups, associated part(s), adjustments, loose/leaking clamps, installation and start-up.
4. Use of Non-Generac replacement part(s) will void the warranty in its entirety.
5. Any failure caused by contaminated fuels, oils, coolants/antifreeze or lack of proper fuels, oils or coolants/antifreeze.
6. Failures due, but not limited to, normal wear and tear, accident, misuse, abuse, negligence, or improper installation or sizing.
7. Failures caused by any external cause or act of God such as collision, fire, theft, freezing, vandalism, riot or wars, lightning, earthquake, windstorm, hail, volcanic eruption, water or flood, tornado, hurricane, terrorist acts or nuclear holocaust.
8. Products that are modified or altered in a manner not authorized by Generac Power Systems in writing.
9. Any incidental, consequential or indirect damages caused by defects in materials or workmanship, or any delay in repair or replacement of the defective part(s).
10. Failure due to misapplication, misrepresentation, or bi-fuel conversion.
11. Telephone, telegraph, teletype or other communication expenses.
12. Living or travel expenses of person(s) performing service, except as specifically included within the terms of a specific unit warranty period.
13. Rental equipment used while warranty repairs are being performed i.e. rental generators, cranes, etc..
14. Overtime labor or more than one person performing repairs.
15. Any and all expenses incurred investigating performance complaints unless defective Generac materials and or workmanship were the direct cause of the problem.
16. \*Engine coolant heaters (block-heaters), heater controls and circulating pumps after the first year.
17. \*Starting batteries, fuses, light bulbs, engine fluids, tires, brakes, and overnight freight cost for replacement part(s).

THIS WARRANTY IS IN PLACE OF ALL OTHER WARRANTIES, EXPRESSED OR IMPLIED, SPECIFICALLY, GENERAC POWER SYSTEMS MAKES NO OTHER WARRANTIES AS TO THE MERCHANTABILITY OR FITNESS FOR A PARTICULAR PURPOSE. Some states do not allow limitations on how long an implied warranty lasts, so the above limitation may not apply to you.

GENERAC POWER SYSTEMS ONLY LIABILITY SHALL BE THE REPAIR OR REPLACEMENT OF PART(S) AS STATED ABOVE. IN NO EVENT SHALL GENERAC POWER SYSTEMS BE LIABLE FOR ANY INCIDENTAL, OR CONSEQUENTIAL DAMAGES, EVEN IF SUCH DAMAGES ARE A DIRECT RESULT OF GENERAC POWER SYSTEMS, INC. NEGLIGENCE.

Some states do not allow the exclusion or limitation of incidental or consequential damages, so the above limitations may not apply to you. Purchaser/owner agrees to make no claims against Generac Power Systems, Inc. based on negligence. This warranty gives you specific legal rights. You also may have other rights that vary from state to state.

**GENERAC® POWER SYSTEMS, INC. · P.O. BOX 8 · WAUKESHA, WI 53187**

**PH: (262) 544-4811 · FAX: (262) 544-4851**

Bulletin 0166260SBY / Printed in USA 5.02