

---

## INSTALLATION INSTRUCTIONS

---

Original Issue Date: 1/01

Model: **550 Generator Set Controllers, Series 500 and 1000 ATS Controllers, Advanced Digital Controls (ADC 2100), and 16-Light Microprocessor Controllers\***

Market: **ATS, Industrial, Marine, and Residential/Commercial**

Subject: **Program Loader Software**

### Introduction

The controller application program is a set of instructions that tell the controller how to operate (similar to the operating system on a computer). Use the Program Loader software and a personal computer to update the application program on the following controllers:

- Model 550 generator set controllers
- Advanced Digital Control (ADC 2100) generator set controllers
- 16-light microprocessor generator set controllers \*
- Series 1000 ATS controllers
- Series 500 ATS controllers

Program Loader also loads personality profiles onto the Model 550 controller. See Section 1 for more information.

The Program Loader overwrites the original programs in the controller's nonvolatile memory.

Use the Program Loader to reload files only in the case of application program upgrade, controller replacement, or file corruption. Load files from the disk shipped with the equipment or obtain new files for your system directly from the manufacturer. (See Requesting Program Loader section.) Make a backup copy of the files onto a disk and store the disks in a safe place.

Program Loader software and controller application program files can be requested through the KOHLERnet. Use your SecurID to access the KOHLERnet, click on the TechTools button, and follow the instructions to request files.

Read the entire procedure before beginning. Install the program loader software onto a personal computer.

Then proceed to the appropriate section for your controller. Carefully follow these instructions and any additional instructions that appear on the screen during the upload procedure. Do not attempt to modify the program or data files. Loading incorrect or incomplete files can cause permanent damage to the controller's main logic board.

### System Requirements

- 100% IBM® PC compatible with a 133 MHz or higher Pentium®-compatible CPU.
- Microsoft® Windows® 98, Windows NT® Workstation Version 4.0, Windows® 2000 Professional, Windows® Me, or Windows XP® operating system.
- CD-ROM drive and minimum of 4 MB hard drive space for installation.
- One 57.6k baud RS-232 serial port, numbered between COM1 and COM16.
- Computers running Windows® 2000 and communicating through USB ports may require a serial adapter card to connect the PC to the ATS controller. (The Socket™ PCMCIA Serial Adapter card is one example).
- Stable power supply. A laptop system with a fully charged battery or desktop system running with a battery backup system is recommended.
- Null modem RS-232 cable with a 9-pin male plug on the controller end (GM16657). (Not required for the 16-light microprocessor controller.)
- For the 16-light microprocessor controller only: RS-232 to RS-485 converter (GM29361) and shielded twisted-pair cable (Belden #9841 or equivalent).

\* 16-light microprocessor generator set controllers with red main logic boards, shipped November, 2003 or later

Pentium® is a registered trademark of Intel Corporation.

IBM® is a registered trademark of International Business Machines Corporation.

Microsoft®, Windows®, and Windows NT® are registered trademarks of Microsoft Corporation.

## Safety Precautions

Observe the following safety precautions while using the kit.

### WARNING

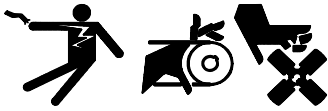

#### **Accidental starting. Can cause severe injury or death.**

Disconnect the battery cables before working on the generator set. Remove the negative (-) lead first when disconnecting the battery. Reconnect the negative (-) lead last when reconnecting the battery.

**Disabling the generator set. Accidental starting can cause severe injury or death.** Before working on the generator set or connected equipment, disable the generator set as follows: (1) Move the generator set master switch to the OFF position. (2) Disconnect the power to the battery charger. (3) Remove the battery cables, negative (-) lead first. Reconnect the negative (-) lead last when reconnecting the battery. Follow these precautions to prevent starting of the generator set by an automatic transfer switch, remote start/stop switch, or engine start command from a remote computer.

### DANGER



#### **Hazardous voltage. Will cause severe injury or death.**

Only authorized personnel should open the enclosure.

### DANGER



#### **Hazardous voltage. Will cause severe injury or death.**

Disconnect all power sources before opening the enclosure.

## Program Loader Version Numbers

The Program Loader software is periodically updated as new controllers are added. Check Figure 1 to determine the Program Loader software version number required to load programs onto your controller.

If the Program Loader software is already installed on your PC, check the software version number by opening the Program Loader software, clicking on the Help menu, and clicking on About Program Loader in the dropdown menu. See Figure 2.

If you already have the required version of Program Loader installed on your PC, proceed to the appropriate section of these instructions for your controller:

- Section 1, Model 550 Generator Set Controllers
- Section 2, Advanced Digital Control (ADC 2100) Generator Set Controllers
- Section 3, 16-Light Microprocessor Controllers
- Section 4, Series 1000 ATS Controllers
- Section 5, Series 500 ATS Controllers

Controller	Version Required
Model 550 Generator Set and Series 1000 ATS Controllers	2.2.1 or higher
Advanced Digital Control (ADC)	2.3.0 or higher
16-light Microprocessor Controller	2.4.0 or higher
Series 500 ATS Controller	2.5.0 or higher

**Figure 1** Program Loader Software Version Numbers

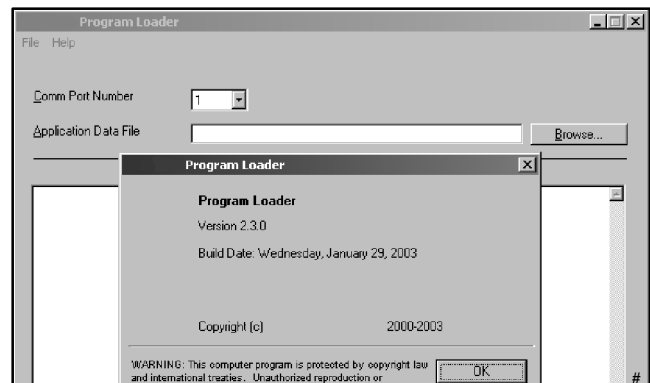

**Figure 2** Program Loader Version Number Identification

## Requesting Program Loader

Use the following procedure to request Program Loader software through the KOHLERnet.

### Procedure to Obtain Program Loader Software

1. Log onto the KOHLERnet using your SecurID password.
2. In the Kohler® Power Systems opening screen, click on Tech Tools.
3. Choose Industrial from the list of product lines on the screen.
4. On the Industrial screen, click on Software under the Subject heading.
5. On the IndustrialSoftware screen, click on Program Loader under the Subject heading.
6. The next screen gives instructions to request the software. Follow those instructions carefully.
7. The software will be sent in .ZIP formatted files. Create a new directory on your PC and save the files to that new directory. Then use an unzipping program to extract the files. Follow the instructions provided with the unzipping program.
8. Proceed to the next section to install the Program Loader software on your PC.

## Installing Program Loader

**Note:** If you have a previous version of Program Loader installed on your PC and want to install a new version, use your computer's Add/Remove Programs function to remove the old version of Program Loader before installing the new one. (Choose Start→Settings→Control Panel→Add/Remove Programs.)

1. Close all applications.
2. Use your computer's Explorer to open the directory where the Program Loader software files are stored.
3. Select the Setup application file to install the program.
4. The setup procedure will install the program loader on your computer's hard drive (typically drive C) in C:\Program Files\Program Loader. Follow the instructions on the screen to proceed with the installation or to change the directory if you would like the software to be installed in a different directory.
5. If an error occurs, follow the recommendations on the screen to troubleshoot the installation.

After the Program Loader Software is installed onto the PC, proceed to the appropriate section of these instructions for your controller:

- Section 1, Model 550 Generator Set Controllers
- Section 2, Advanced Digital Control (ADC 2100) Generator Set Controllers
- Section 3, 16-Light Microprocessor Controllers
- Section 4, Series 1000 ATS Controllers
- Section 5, Series 500 ATS Controllers

# 1 Model 550 Generator Set Controllers

The Program Loader software is used to load controller application program and/or generator set personality profiles onto the Model 550 generator set controller. The personality profile is a data file that contains the generator set parameters and is specific to the generator set serial number. The files are loaded onto the generator set controller at the factory at the time of manufacture and a backup disk containing the controller application program and the personality profile is shipped with the generator set.

## 1.1 Prepare the controller and connect to the PC.

1. Save or record the controller's user-defined settings.
  - a. Write the controller's user-defined settings in the chart provided in the controller operation manual. See the controller operation manual for instructions; or
  - b. Use the Monitor II Generator System Monitoring and Control Software to save the user configuration settings to a backup file before uploading new files to the controller. See the Monitor II Software Operation and Installation Manual for instructions.
2. Place the generator set master switch in the OFF/RESET position.
3. Disconnect the power to the generator set battery charger, if equipped.
4. Disconnect the generator set engine starting battery(ies), negative (-) lead first.
5. Remove the screws from the controller's top cover and remove the cover.
6. Remove the top screws on the front side of the controller. Loosen the bottom screws to allow the front panel to swing open.
7. Connect one end of the null modem cable to the controller at the RS-232 connector P18. See Figure 3. Tighten the thumb screws on the connector to hold it securely in place.
8. Connect the other end of the null modem cable to the computer's RS-232 communication (COM) port. Tighten the thumbscrews on the connector to hold it securely in place.

## 1.2 Load the controller files.

9. Start the Program Loader by selecting the Program Loader from the PC's Start menu. Click on the Start button at the lower left corner of the screen, select Programs, select the directory that contains the Program Loader software, and click on Program Loader.
10. Enter the number of the computer's COM port (number 1 through 16) that is connected to the controller through the communication cable. See Figure 4.

**Note:** While the program supports COM ports 1 through 16, most computers use only ports 1 through 4. Contact your computer equipment supplier for help determining which port is available.

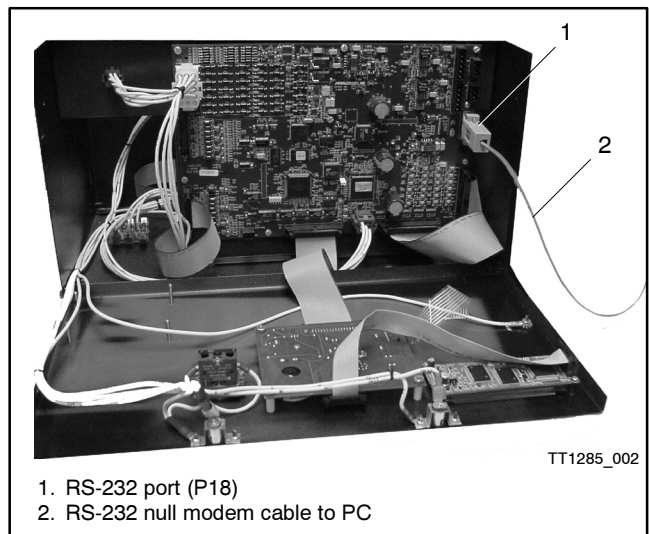

Figure 3 550 Controller RS-232 Connection

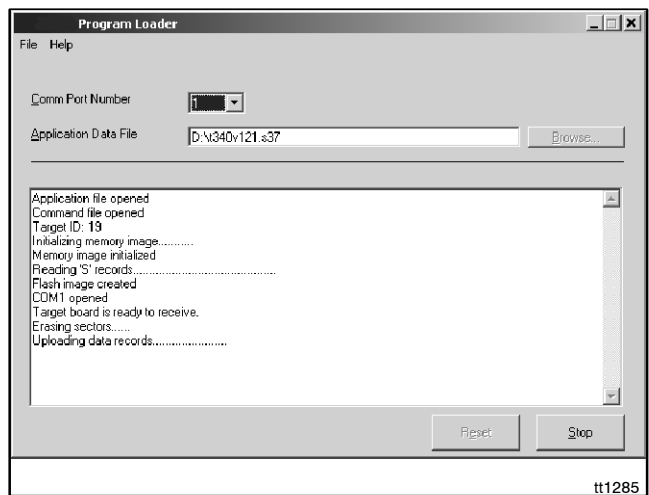

Figure 4 Program Loader Screen

11. If the application files or personality parameter files are stored on a disk, insert the disk into the computer's disk drive.
12. Select the application file for your system's engine and alternator. Application files and personality parameter files have ".s19" or ".s37" extensions on the filenames. Use only files obtained directly from the manufacturer. There are different ways to select the file:
  - Select File>Open or click on the Browse button to open the standard Windows file open dialog box to select a file; or
  - Type the path and filename directly into the Application Data File text box. Do not use spaces or periods in the path name of the directory where the files are stored.

**Note:** Do not move the application files to a different directory. Two separate files are needed for all uploads: an application file with a ".s19" or ".s37" file extension and a command file with a ".cmd" file extension. Both files must exist in the same directory, even though the user will not see the command file.
13. Click the Run button on the computer screen. The program performs its memory initialization.

**Note:** If the wrong COM port was selected in step 7, an error message will appear during the initialization. Click RESET, select a different COM port, and click RUN to begin again.
14. The program will prompt you to reset the target controller. Reset the 550 controller by reconnecting the engine start battery cable, negative (-) lead last.
15. A warning dialog box appears providing one last chance to abort the data loading process. Click the OK button to start loading. The loading process may take several minutes.

**Note:** Do not interrupt the upload process for any reason. An interruption of the upload process could cause permanent damage to the controller's programming, requiring replacement of the controller's main logic board and additional reprogramming.
16. The program indicates whether the file transfer was successful. "Upload complete" indicates that the file transfer was successful.

17. Close the program by selecting File>Exit, or by clicking the Close Window button in the upper right corner of the computer screen.

If you want to use Program Loader again, click the RESET button at the bottom of the screen rather than exiting the program.

### 1.3 Reset the controller.

18. Reset the controller by disconnecting and then reconnecting the generator set engine starting battery(ies) as instructed in the following steps.
  - a. Disconnect the generator set engine starting battery(ies), negative (-) lead first.
  - b. Reconnect the generator set engine starting battery, negative (-) lead last.
19. Reconnect power to the battery charger, if equipped.

### 1.4 Check the controller settings.

20. Check the controller settings. If you used the Monitor II software to retrieve the controller's user settings before uploading the new files, you may now use Monitor II to restore those settings to the controller. Follow the instructions in the Software Operation and Installation Manual. Otherwise, follow the instructions in the controller operation manual to enter user settings using the controller keypad and display.

### 1.5 Return to automatic operation.

21. Disconnect the null modem cable from the computer and the controller.
22. Close the enclosure's front panel. Install and tighten the screws.
23. Replace the enclosure's top cover. Install and tighten the screws.
24. Test the generator set operation. Refer to the generator set operation manual for instructions to start and run the generator set.
25. Place the generator set master switch in the AUTO position.

## 2 Advanced Digital Control (ADC 2100)

The Program Loader software is used to load the controller application program onto the ADC 2100 generator set controller. After loading the new program onto the controller, set the generator set parameters (i.e. voltage, unit configuration, engine configuration, 12/24 VDC, etc.). For instructions to set the parameters, see the generator set Service Manual.

**Note:** Version 2.3.0 or higher of the Program Loader software is required to load programs onto the Advanced Digital Control generator set controller.

### 2.1 Prevent the generator set from starting.

1. Move the generator set master switch to the OFF/RESET position.
2. Disconnect power to the battery charger, if equipped.
3. Disconnect the generator set engine starting battery, negative (-) lead first.

### 2.2 Remove the controller from the generator set.

4. Disconnect the engine wiring harness connector P1 plug (35-pin) from the controller. Disconnect the J15 and J16 connectors. See Figure 5.
5. Remove the controller from the generator set in order to access the back of the controller.

### 2.3 Prepare the controller and connect to the PC.

6. Note the labels on the three leads connected to the generator set master switch for reconnection later. Disconnect the leads at the pink connectors. See Figure 5, item 3.
7. Remove the controller's back cover.
8. Connect a null modem cable from the serial port of the computer to the RS-232 connector on the back of the ADC controller. See Figure 5, item 2.
9. Reconnect the three pink connectors to the generator set master switch.

10. Reconnect the engine wiring harness connector P1 plug (35-pin) to the controller.
11. Reconnect the generator set engine start battery, negative (-) lead last.
12. Reconnect power to the battery charger, if equipped.

**Note:** Connect the P1 plug, battery, and battery charger, if equipped, as instructed above to provide power to the controller during the software loading process.

### 2.4 Load the controller files.

13. Start the Program Loader by selecting the Program Loader from the PC's Start menu. Click on the Start button at the lower left corner of the screen, select Programs, select the directory that contains the Program Loader software, and click on Program Loader.

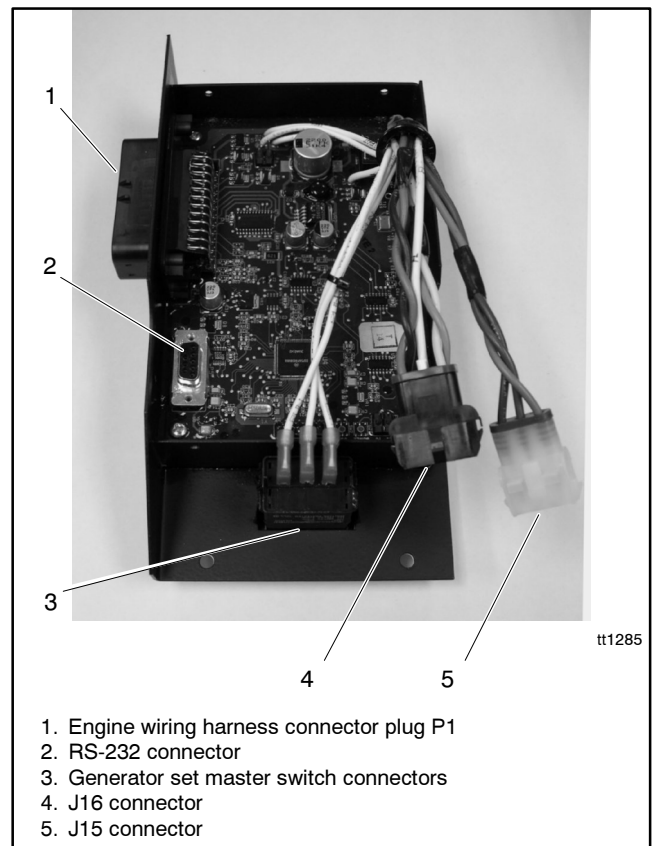
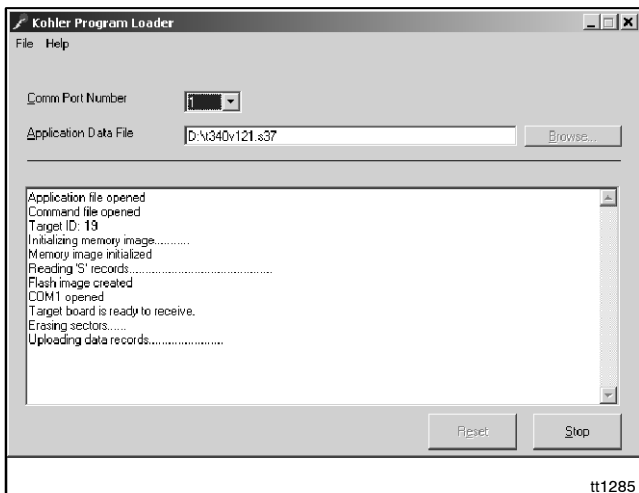

**Figure 5** Advanced Digital Control Connections

14. Enter the number of the computer's COM port (number 1 through 16) that is connected to the controller through the communication cable. See Figure 6.

**Note:** While the program supports COM ports 1 through 16, most computers use only ports 1 through 4. Contact your computer equipment supplier for help determining which port is available.

15. If the application files are stored on a disk, insert the disk into the computer's disk drive.



**Figure 6** Program Loader Screen

16. Select the application file. Application files have “.s19” or “.s37” extensions on the filenames. Use only files obtained directly from the manufacturer. There are different ways to select the file:

- Select File>Open or click on the Browse button to open the standard Windows file open dialog box to select a file; or
- Type the path and filename directly into the Application Data File text box. Do not use spaces or periods in the path name of the directory where the files are stored.

**Note:** Do not move the application files to a different directory. Two separate files are needed for all uploads: an application file with a “.s19” or “.s37” file extension and a command file with a “.cmd” file extension. Both files must exist in the same directory, even though the user will not see the command file.

17. Click the Run button on the computer screen. The program performs its memory initialization.

**Note:** If the wrong COM port was selected in step 7, an error message will appear during the initialization. Click RESET, select a different COM port, and click RUN to begin again.

18. The program will prompt you to reset the target controller. Reset the ADC controller by moving the master switch to the RUN position. The controller display remains dark.
19. A warning dialog box appears providing one last chance to abort the data loading process. Click the OK button to start loading. The loading process may take several minutes.

**Note:** Do not interrupt the upload process for any reason. An interruption of the upload process could cause permanent damage to the controller's programming, requiring replacement of the controller's main logic board and additional reprogramming.

20. The program indicates whether the file transfer was successful. “Upload complete” indicates that the file transfer was successful.
21. Close the program by selecting File>Exit, or by clicking the Close Window button in the upper right corner of the computer screen.

If you want to use Program Loader again, click the RESET button at the bottom of the screen rather than exiting the program.

## 2.5 Return to operation.

22. Disconnect power to the battery charger, if equipped.
23. Disconnect the generator set engine starting battery, negative (-) lead first.
24. Disconnect the null modem cable from the computer and the controller.
25. Disconnect the three pink connectors from the generator set master switch.
26. Replace the controller's back cover and tighten the cover screws.
27. Reconnect the three pink connectors to the generator set master switch.
28. Reconnect the J15 and J16 connectors.

29. Reconnect the generator set engine starting battery, negative (-) lead last.
30. Reconnect power to the battery charger, if equipped.

## 2.6 Check the settings and adjust, if necessary.

31. Use the controller display and keypad to check the generator set parameters (i.e. system voltage, unit configuration, engine configuration, 12/24 VDC, etc.) and set them to the appropriate settings for your system. These settings are password-protected; see the generator set Service Manual or TT-1364, ADC 2100 Replacement, for instructions and system settings.

## 2.7 Check the application program version number.

**Note:** This step is optional.

32. Move the generator set master switch to the OFF/RESET position.
33. Press and hold the Select button on the ADC controller. See Figure 7. Move the generator set master switch to the RUN position. (The generator set will not start if the Select button is pressed.)

34. Watch the LED display on the ADC controller. After approximately 5 seconds, the LED display will change to show the software version number (for example, 1.01).

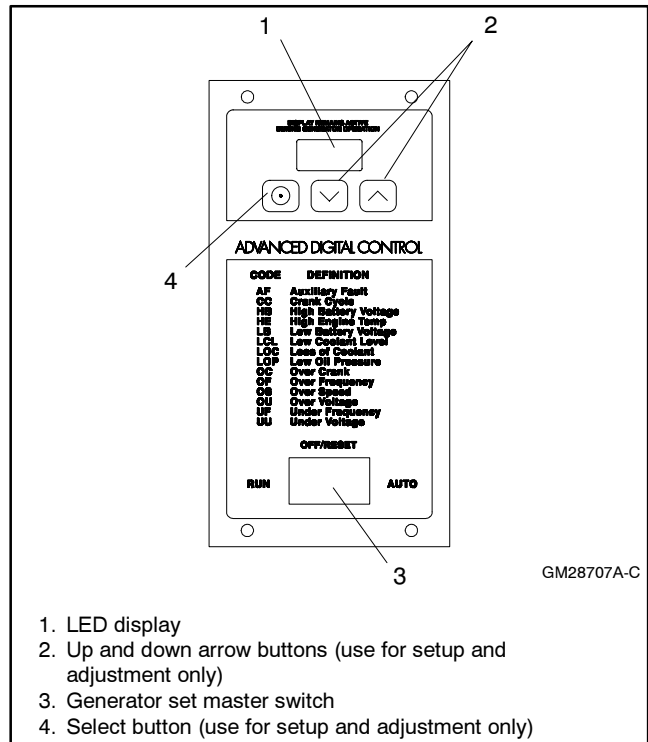

**Figure 7** Advanced Digital Controller User Interface

### 3 16-Light Microprocessor Controllers

Use the Program Loader software to load controller application program onto 16-light controllers with red main logic boards (shipped November, 2003 or later).

**Note:** Version 2.4.0 or higher of the Program Loader software is required to load programs onto the 16-light microprocessor controller.

#### 3.1 Prevent the generator set from starting.

1. Move the generator set master switch to the OFF/RESET position.
2. Disconnect power to the battery charger, if equipped.
3. Disconnect the generator set engine starting battery, negative (-) lead first.

#### 3.2 Connect the controller to the personal computer (PC).

**Note:** Shielded twisted pair cable (customer-supplied, Belden #9841 or equivalent) and an RS-232 to RS-485 converter (available from the factory, part number GM29361) are required in order to connect the controller to a personal computer.

4. Connect the RS-232 side of the RS-232 to RS-485 converter to the serial port on the PC. See Figure 8.
5. Use shielded twisted-pair cable (Belden #9841 or equivalent) to connect the RS-232 to RS-485 converter to the TB5 connector on the controller's main logic board. See Figure 9 and Figure 10.

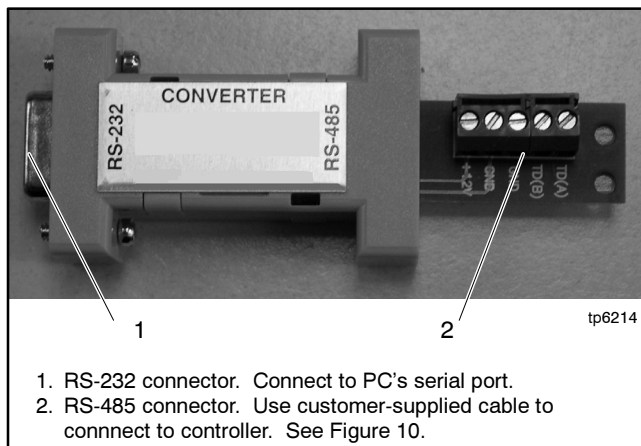

**Figure 8** RS-232 to RS-485 Converter (available from the factory)

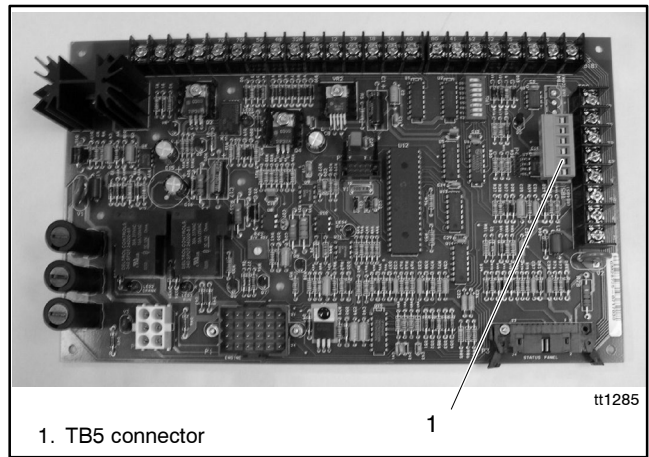

**Figure 9** Controller Main Logic Board

#### 3.3 Load the controller files.

6. Start the Program Loader by selecting the Program Loader from the PC's Start menu. Click on the Start button at the lower left corner of the screen, select Programs, select the directory that contains the Program Loader software, and click on Program Loader.
7. Enter the number of the computer's COM port (number 1 through 16) that is connected to the controller through the communication cable. See Figure 11.  
**Note:** While the program supports COM ports 1 through 16, most computers use only ports 1 through 4. Contact your computer equipment supplier for help determining which port is available.
8. Insert the disk containing the application files into the computer's disk drive.

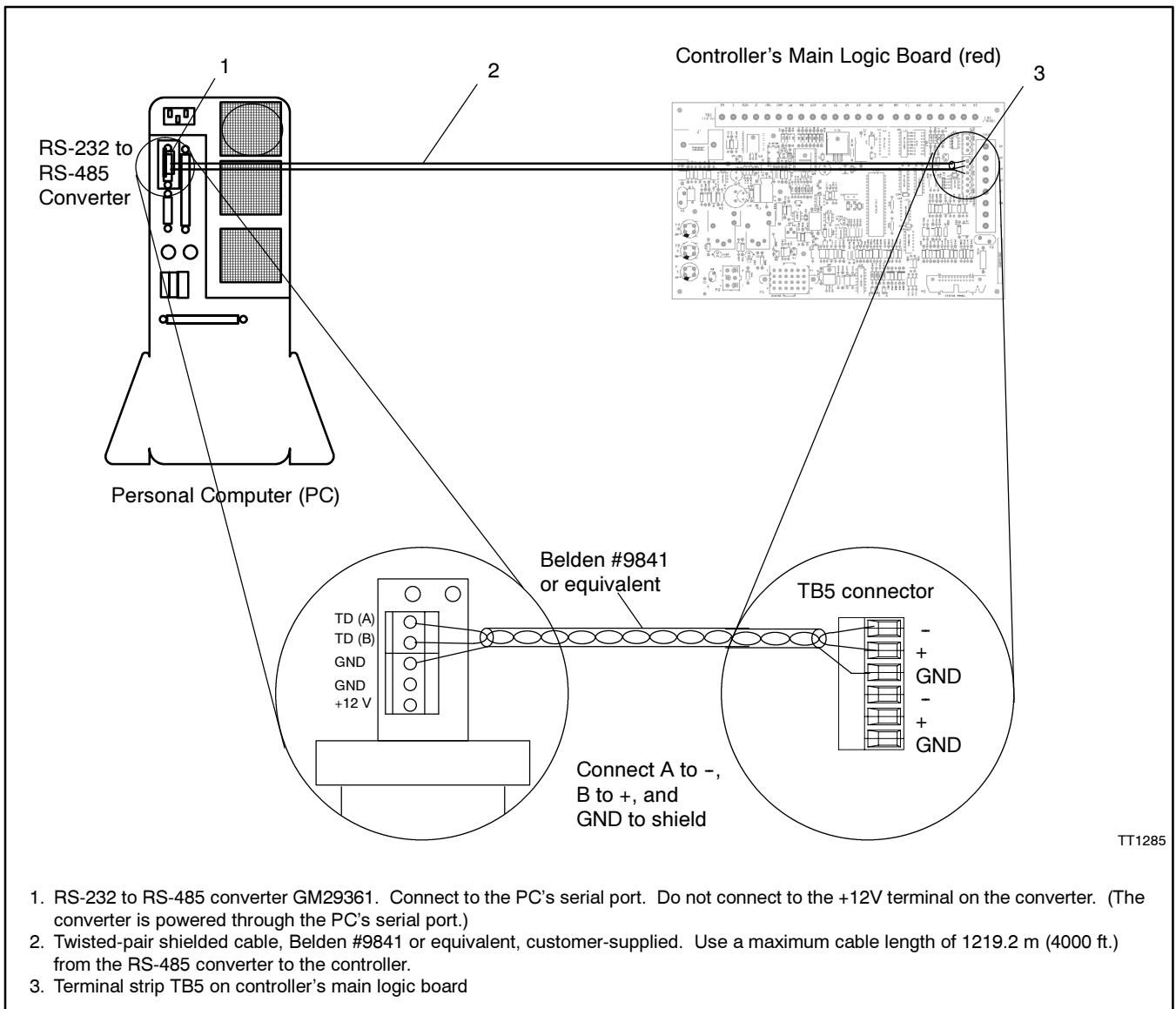

**Figure 10** 16-Light Microprocessor Controller-to-Personal Computer Connection

9. Select the application file for your system's engine and alternator. Application files and personality parameter files have ".s19" or ".s37" extensions on the filenames. Use only files obtained directly from the manufacturer. There are different ways to select the file:

- Select File>Open or click on the Browse button to open the standard Windows file open dialog box to select a file; or
- Type the path and filename directly into the Application Data File text box. Do not use spaces or periods in the path name of the directory where the files are stored.

**Note:** Do not move the application files to a different directory. Two separate files are needed for all uploads: an application file with a ".s19" file extension and a command file with a ".cmd" file extension. Both files must exist in the same directory, even though the user will not see the command file.

10. Click the Run button on the computer screen. The program performs its memory initialization.

**Note:** If the wrong COM port was selected in step 7, an error message will appear during the initialization. Click RESET, select a different COM port, and click RUN to begin again.

11. The program will prompt you to reset the target controller. Reset the controller by reconnecting the engine start battery cable, negative (-) lead last.
12. A warning dialog box appears providing one last chance to abort the data loading process. Click the OK button to start loading. The loading process may take several minutes.

**Note:** Do not interrupt the upload process for any reason. An interruption of the upload process could cause permanent damage to the controller's programming, requiring replacement of the controller's main logic board and additional reprogramming.

13. The program indicates whether the file transfer was successful. "Upload complete" indicates that the file transfer was successful.
14. Close the program by selecting File>Exit, or by clicking the Close Window button in the upper right corner of the computer screen.

If you want to use Program Loader again, click the RESET button at the bottom of the screen rather than exiting the program.

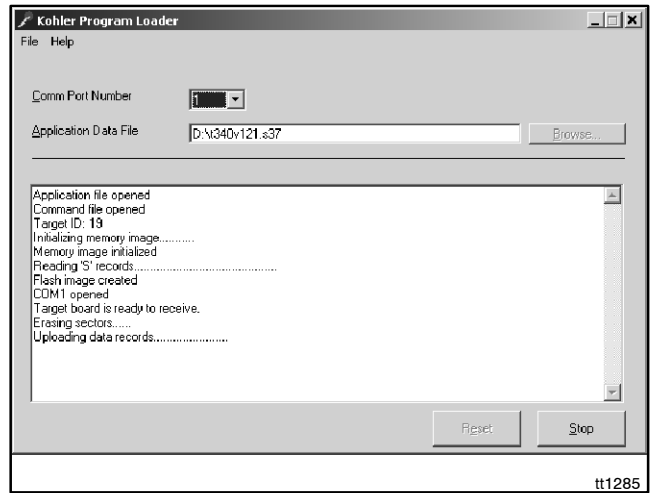

Figure 11 Program Loader Screen

### 3.4 Return to operation.

15. Disconnect the generator set engine starting battery, negative (-) lead first.
16. Disconnect the communication cable from the controller.
17. Close and secure the controller enclosure.
18. Reconnect the generator set engine starting battery, negative (-) lead last.
19. Reconnect power to the battery charger, if equipped.
20. Place the generator set master switch in the AUTO position for automatic operation.

## 4 Series 1000 ATS Controllers

Use the Program Loader software to load the controller application program onto the Series 1000 ATS controller, shown in Figure 12. After loading the new program onto the controller, use the Setup program to set the transfer switch parameters if they are different from the default settings. See the Setup Program Software Operation and Installation Manual for instructions.

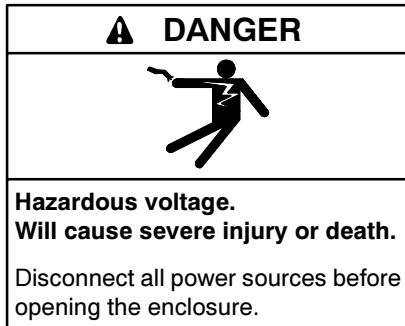

### 4.1 Prepare the controller and connect to the PC.

1. If possible, use the Setup Program to save the system settings to a backup file or record the user-defined controller settings before uploading new files to the controller. See the Setup Program Operation and Installation Manual for instructions.
2. Place the generator set master switch in the OFF/RESET position.
3. Disconnect the power to the generator set battery charger, if equipped.
4. Disconnect the generator set engine starting battery(ies), negative (-) lead first.

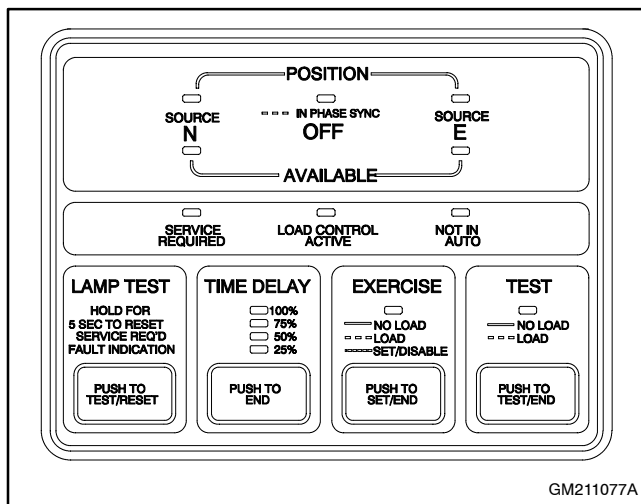

Figure 12 Series 1000 ATS Controller

5. Disconnect all power sources to the transfer switch by opening switches or circuit breakers.
6. Open the transfer switch enclosure door.
7. Connect one end of the null modem cable to the controller at the RS-232 connector. See Figure 14. Tighten the thumb screws on the connector to hold it securely in place.
8. Connect the other end of the null modem cable to the computer's RS-232 communication (COM) port. Tighten the thumbscrews on the connector to hold it securely in place.
9. Close the enclosure door and reconnect power to the transfer switch. The transfer switch controller must have power connected during the software download.

### 4.2 Load the controller files.

1. Start the Program Loader by selecting the Program Loader from the PC's Start menu. Click on the Start button at the lower left corner of the screen, select Programs, select the directory that contains the Program Loader software, and click on Program Loader.
2. Enter the number of the computer's COM port (number 1 through 16) that is connected to the controller through the communication cable. See Figure 13.

**Note:** While the program supports COM ports 1 through 16, most computers use only ports 1 through 4. Contact your computer equipment supplier for help determining which port is available.

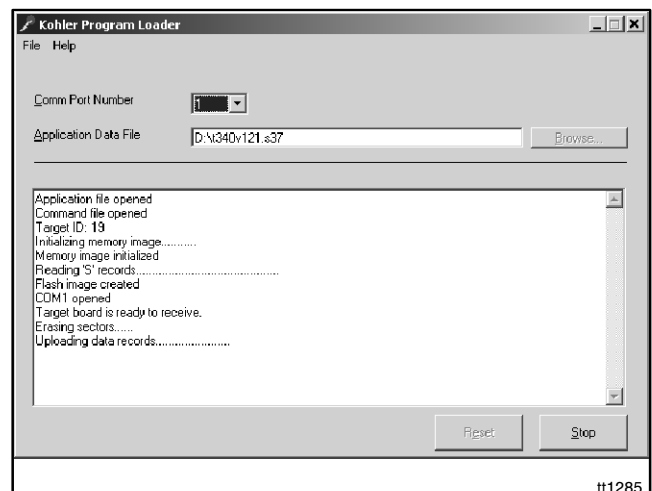

Figure 13 Program Loader Screen

3. If the application files are stored on a disk, insert the disk into the computer's disk drive.
4. Select the application file. Application files have ".s19" or ".s37" extensions on the filenames. Use only files obtained directly from the manufacturer. There are different ways to select the file:

- Select File>Open or click on the Browse button to open the standard Windows file open dialog box to select a file; or
- Type the path and filename directly into the Application Data File text box. Do not use spaces or periods in the path name of the directory where the files are stored.

**Note:** Do not move the application files to a different directory. Two separate files are needed for all uploads: an application file with a ".s19" or ".s37" file extension and a command file with a ".cmd" file extension. Both files must exist in the same directory, even though the user will not see the command file.

5. Click the Run button on the computer screen. The program performs its memory initialization.

**Note:** If the wrong COM port was selected in step 7, an error message will appear during the initialization. Click RESET, select a different COM port, and click RUN to begin again.

6. The program will prompt you to reset the target controller. Reset the transfer switch controller by performing the following steps:
  - Hold down the Lamp Test button until the controller LEDs flash. Do not release the button.
  - Continue to hold down the Lamp Test button and press the End Time Delay button. The LEDs flash when the controller resets.
7. A warning dialog box appears providing one last chance to abort the data loading process. Click the OK button to start loading. The loading process may take several minutes.

**Note:** Click OK on the Program Loader screen within 5 seconds after resetting the controller and watch for the program to indicate "Uploading data records." The ATS controller LEDs flash rapidly during file transfer. If the "Uploading data records" message does not appear, click the STOP button in the lower right corner of the screen and start again.

**Note:** Do not interrupt the upload process for any reason. An interruption of the upload process could cause permanent damage to the controller's programming, requiring replacement of the controller's main logic board and additional reprogramming.

8. The program indicates whether the file transfer was successful. "Upload complete" indicates that the file transfer was successful.
9. Close the program by selecting File>Exit, or by clicking the Close Window button in the upper right corner of the computer screen.

If you want to use Program Loader again, click the RESET button at the bottom of the screen rather than exiting the program.

### 4.3 Check the controller settings.

10. Check the controller settings, including system parameters, time delays, and exerciser settings. Follow the instructions in the Setup Program Software Operation and Installation Manual to enter settings using the PC.
11. Check the DIP switch settings on the controller's main logic board. See the Transfer Switch Operation and Installation Manual for instructions.

### 4.4 Return to automatic operation.

12. Disconnect power to the transfer switch.
13. Disconnect the null modem cable from the computer and the controller.
14. Close and secure the ATS enclosure door.

15. Reconnect power to the transfer switch.
16. Reconnect the generator set engine starting battery, negative (-) lead last.
17. Reconnect power to the battery charger, if equipped.
18. Place the generator set master switch in the AUTO position.
19. If the ATS controller is set for manual exercise mode, press the Exercise button on the controller user interface to start an exercise run and set the exercise time.
20. Run a test to check the transfer switch operation. Refer to the Transfer Switch Operation and Installation Manual for the test procedure.

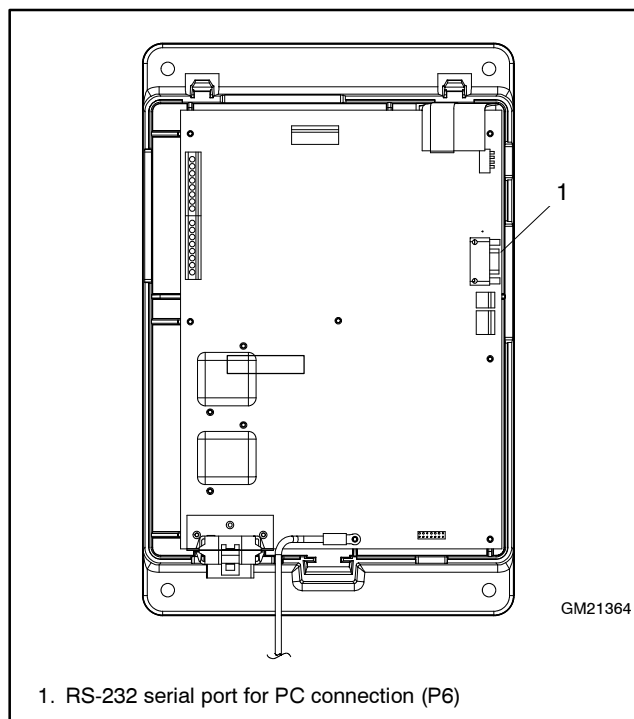

**Figure 14** ATS Controller RS-232 Connection

## 5 Series 500 ATS Controllers

Use the Program Loader software to load the controller application program onto the Series 500 ATS controller, shown in Figure 15.

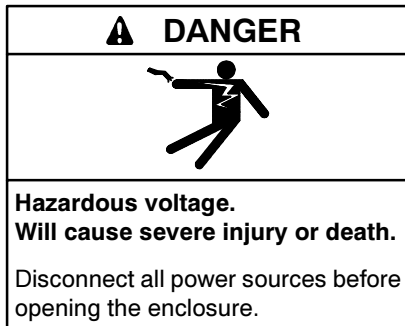

### 5.1 Prepare the controller and connect to the PC.

1. Place the generator set master switch in the OFF/RESET position.
2. Disconnect the power to the generator set battery charger, if equipped.
3. Disconnect the generator set engine starting battery(ies), negative (-) lead first.
4. Disconnect all power sources to the transfer switch by opening switches or circuit breakers.
5. Open the transfer switch enclosure door.

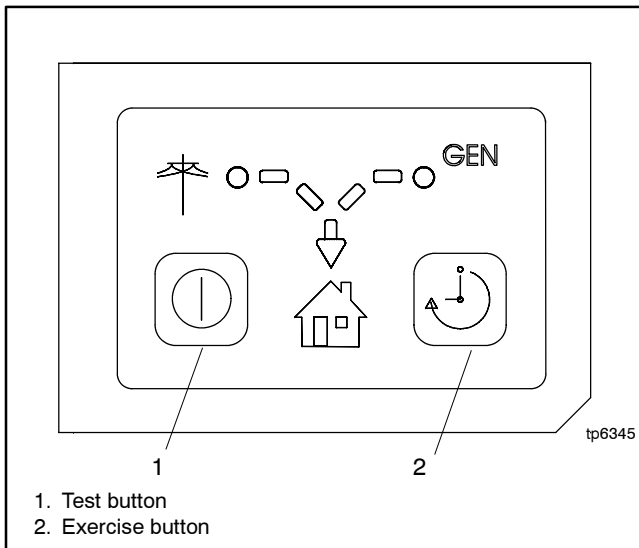
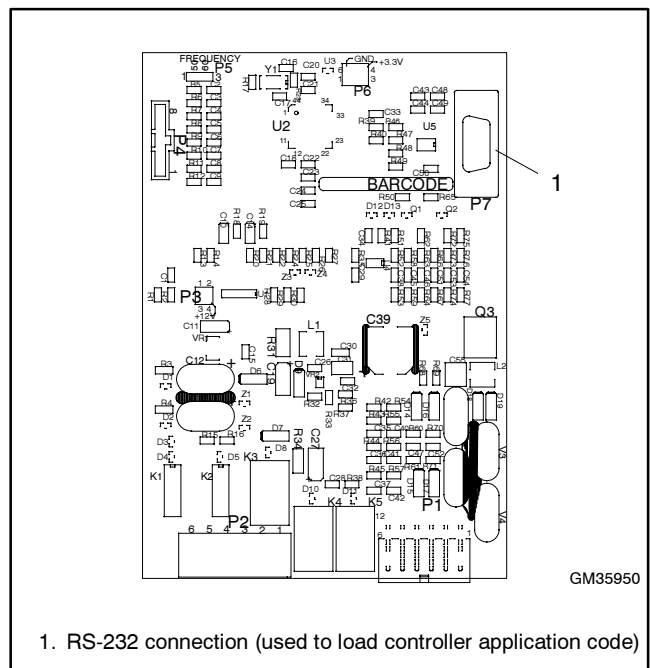

**Figure 15** Series 500 ATS Controller

6. Connect one end of the null modem cable to the controller at the RS-232 connector. See Figure 16. Tighten the thumb screws on the connector to hold it securely in place.
7. Connect the other end of the null modem cable to the computer's RS-232 communication (COM) port. Tighten the thumbscrews on the connector to hold it securely in place.
8. Close the enclosure door and reconnect power to the transfer switch. The transfer switch controller must have power connected during the software download.

### 5.2 Load the controller files.

1. Start the Program Loader by selecting the Program Loader from the PC's Start menu. Click on the Start button at the lower left corner of the screen, select Programs, select the directory that contains the Program Loader software, and click on Program Loader.



**Figure 16** Series 500 ATS Controller RS-232 Connection

2. Enter the number of the computer's COM port (number 1 through 16) that is connected to the controller through the communication cable. See Figure 17.

**Note:** While the program supports COM ports 1 through 16, most computers use only ports 1 through 4. Contact your computer equipment supplier for help determining which port is available.

3. If the application files are stored on a disk, insert the disk into the computer's disk drive.
4. Select the application file. Application files have .s19 extensions on the filenames. Use only files obtained directly from the manufacturer. There are different ways to select the file:
  - Select File>Open or click on the Browse button to open the standard Windows file open dialog box to select a file; or
  - Type the path and filename directly into the Application Data File text box. Do not use spaces or periods in the path name of the directory where the files are stored.

**Note:** Do not move the application files to a different directory. Two separate files are needed for all uploads: an application file with a .s19 file extension and a command file with a .cmd file extension. Both files must exist in the same directory, even though the user will not see the command file.

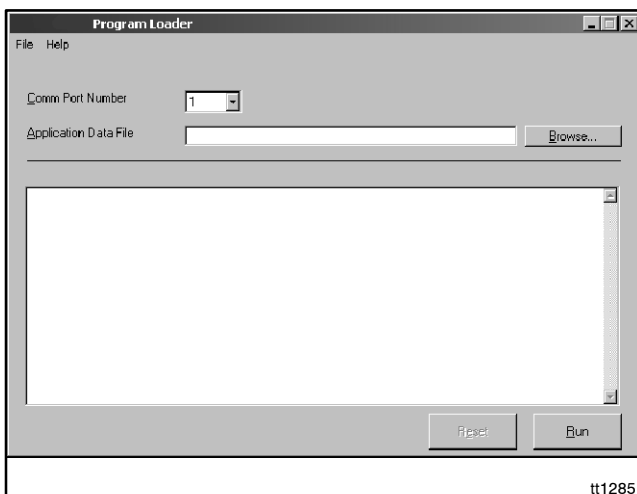

**Figure 17** Program Loader Screen

5. Click the Run button on the computer screen. The program performs its memory initialization.

**Note:** If the wrong COM port was selected in step 7, an error message will appear during the initialization. Click RESET, select a different COM port, and click RUN to begin again.

6. The program will prompt you to reset the target controller. Reset the transfer switch controller by holding both the Test and Exercise buttons for at least six (6) seconds. See Figure 15.

**Note:** The controller LEDs may flash after three seconds. Be sure to continue to hold both buttons for at least six seconds to completely reset the controller.

7. A warning dialog box appears providing one last chance to abort the data loading process. Click OK on the Program Loader screen within 5 seconds after resetting the controller and watch for the program to indicate "Uploading data records." The ATS controller LEDs flash rapidly during file transfer. If the "Uploading data records" message does not appear, click the STOP button in the lower right corner of the screen and start again.

The upload may not start if the controller's diagnostic function is sending information at the same time. Try starting again until the program indicates it is uploading the data records.

**Note:** The loading process may take several minutes. Do not interrupt the upload process for any reason.

8. The program indicates whether the file transfer was successful. "Upload complete" indicates that the file transfer was successful.
9. Close the program by selecting File>Exit, or by clicking the Close Window button in the upper right corner of the computer screen.

If you want to use Program Loader again, click the RESET button at the bottom of the screen rather than exiting the program.

### 5.3 Return to automatic operation.

10. Disconnect power to the transfer switch.
11. Disconnect the null modem cable from the computer and the controller.
12. Close and secure the ATS enclosure door.
13. Reconnect power to the transfer switch.
14. Reconnect the generator set engine starting battery, negative (-) lead last.
15. Reconnect power to the battery charger, if equipped.
16. Place the generator set master switch in the AUTO position.
17. To start an exercise run and set the exercise time, press the Exercise button on the controller user interface. See Figure 15.
18. Run a test to check the transfer switch operation. Refer to the Transfer Switch Operation and Installation Manual for the test procedure.

## 6 Online Help

Use the program's online help system to help you diagnose error messages or problems encountered while running the program. Figure 18 lists the error codes. Refer to the online help system for more information about error codes and suggestions for correcting the errors.

Error Code	Description
2000	Unable to open application file
2001	Unable to open command file
2002	Unable to determine command file name
2003	Unable to get target ID
2004	Unable to establish communication with target
2005	Application not designed for this target board
2006	Maximum number of resends requested
2007	Flash chip programming error

**Figure 18** Error Codes

## 7 Optional File Storage

It is possible, but not necessary, to store the generator set personality profile and controller application files on your computer's hard drive or network. The command and application program files must be stored in the same directory.

Model 550 generator set controller application files are named D550Vxxx.s37 and D550Vxxx.cmd, where xxx is a number indicating the software version. Application files for other controllers use similar types of filenames, with the first few characters identifying the model, a number indicating the software version, and the file extensions .s37 or .s19 and .cmd.

The personality profile files for the Model 550 controller are named p\_params.s37 and p\_params.cmd.

Set up a separate directory or folder on the computer's hard drive or network for each piece of equipment. Give each directory a name that uniquely identifies the generator set or transfer switch. Use Windows® Explorer to copy the files for each generator set or transfer switch from the disk supplied with the equipment into one directory or folder. Store the command and application program files together in the same directory.

**Note:** Do not modify the files. Loading modified files can cause permanent damage to the controller's main logic board.

# Notes



