

INSTRUCTION MANUAL

MODEL : K711B
250 KW, 480 V, 3 P, 60 H
PARTS # : 73864

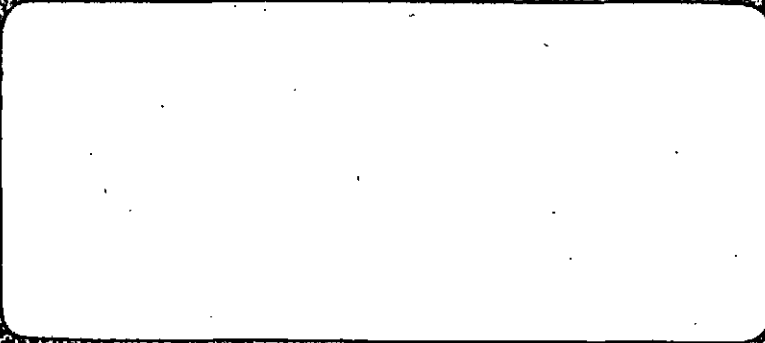

Specialists in the Following Services for Industry

DIGITAL MEASUREMENT AND CONTROL SYSTEMS
TEST EQUIPMENT FOR AIRCRAFT ELECTRICAL COMPONENTS
RESISTIVE AND REACTIVE LOAD BANKS
ROTARY PULSE GENERATORS
AUTOMATIC WINDING TEST SYSTEMS

 **AVTRON** MANUFACTURING INC.

All Sales and Service for
Aircraft Test Equipment
7900 E. Pleasant Valley Rd.
Independence, Ohio 44131-5529
TELEPHONE (216) 642-1230
FACSIMILE (216) 642-6037

Service for All
Other Products
10409 Meech Ave.
Cleveland, Ohio 44105-4183
TELEPHONE (216) 641-8310
FACSIMILE (216) 341-8803

**AVTRON MODEL K711
LOAD BANK, RESISTIVE, DUCT MOUNT
Serial Number 825 and Above**

Project 250358

**AVTRON MODEL K711
LOAD BANK, RESISTIVE, DUCT MOUNT
Serial Number 825 and Above**

© 1996 Avtron Manufacturing, Inc.
Cleveland, Ohio

October 5, 1996
Rev. July 26, 1999

WHEN ORDERING SERVICE OR
REPAIR PARTS, PLEASE SPECIFY
MODEL NO. AND/OR PART NO.
LOCATED ON NAMEPLATE AND
DWG. NO. A26691.

APPLICATION		REVISION				
MODEL/PART. NO.	MODIFIED	ECN	LTR	DESCRIPTION	DATE	APPROVAL
K711B-44-44-480U-FH						

MODIFICATION REQUIRED

SCOPE: PROVIDE LOAD BANK FRAME AND RESISTORS (250KW BULK LOAD); MADE UP OF 5-50KW LOAD STEPS. NO CONTACTORS, FUSES, DISTRIBUTION BLOCK, OR CONTROL PANEL IS TO BE PROVIDED.

ASSEMBLY INSTRUCTIONS:

1. INSTALL RESISTOR ELEMENTS PER K711B ASSEMBLY PRINTS.
2. WIRE THE RESISTOR ELEMENTS PER C23068, FIGURE #2.

NOTE: THE CUSTOMER IS TO PROVIDE THE WIRING FROM THE RESISTOR ELEMENTS TO THE POWER DISTRIBUTION BLOCK. THE RECOMMENDED WIRE IS #6 AWG, 150 DEGREES C., UL TYPE 3321 OR EQUIVALENT. SEE THE SCHEMATIC BELOW.

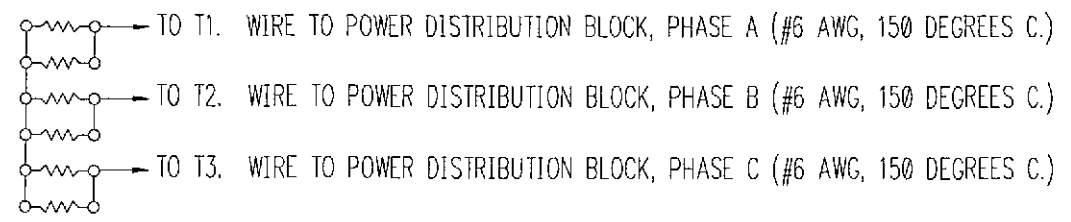

THIS DOCUMENT CONTAINS PROPRIETARY INFORMATION OF AVTRON MFG., INC. AND MAY NOT BE DISCLOSED TO OTHERS OR USED FOR MANUFACTURING PURPOSES WITHOUT THE WRITTEN CONSENT OF AVTRON MFG.

DRAWN KUK	DATE 4/19/00		TITLE MOD., BULK LOAD, TYPE B LESS ENCLOSURE AND DIST. BLOCK PSF		
ENG MGR D.KOZAR	DATE 4/20/00		CAGE NO. 61014	SIZE A	DRAWING NO. A26691
APP'D PROD ZIMMERMAN	DATE 4/21/00		SH 3	OF 3	REV

PROPRIETARY NOTE

This document contains information PROPRIETARY to Avtron Manufacturing, Inc., is furnished solely to provide information sufficient for instruction, operation, maintenance, evaluation, and testing of the equipment herein disclosed, is not to be used for manufacturing or procurement and is not to be disclosed to anyone other than persons in the Division, or the Company, or the Government, as the case may be, responsible for action relating to this document without the express written permission of Avtron Manufacturing, Inc.

WARRANTY

The last page of this document contains an express limited warranty. The provisions of this warranty cover any and all rights extended to holders of Avtron equipment.

Feb. 1995

AVTRON MODEL K711
LOAD BANK, RESISTIVE, DUCT MOUNT
 Part Number K711B-44-44-480U-FH
 MODIFIED PER A26691
 PROJECT NO. 250358

Load Bank Ratings:

Total KW 250 KW
 Operating Voltage (Volts, Phase, Frequency, Amps) 480 VAC,
3 Phase, 60 Hz., 300.7 Amps.
 Load Steps (KW) One 250 KW Bulk Load.
 Minimum airflow required for full load operation 11,616 CFM

TABLE OF CONTENTS

<u>Section</u>		<u>Page</u>
I	SAFETY CONSIDERATIONS	1-1
II	DESCRIPTION AND SPECIFICATIONS	2-1
III	INSTALLATION	3-1
IV	OPERATION	4-1

DRAWINGS

582580 Outline Drawing
C23327 Schematic/Wiring Diagram (Controls)
C23068 Schematic/Wiring Diagram, Load Bank

BULLETINS

202 Installation Notes, Engine Generator,
 Duct or Radiator Type
 203 Sample Calculations, Engine Generator,
 Duct Type Load Banks

**DERIVATION OF K711/K711A LOAD BANK PART NUMBER
AND CALCULATIONS FOR AMPS and AIRFLOW REQUIREMENTS**

The K711/K711A part number identifies the size, electrical characteristics, and the options which apply to a given unit. An explanation of how K711/K711A part numbers are configured and how to decipher them follows:

K711/K711A part numbers take the form K711(A)-YY-XX-VVVU(F)-C-O where:

- YY = HEIGHT IN INCHES
- XX = WIDTH IN INCHES
- VVV = VOLTAGE (208, 240, 480 OR 600V)
- U, F = UNFUSED OR FUSED LOAD STEPS
- C = LOAD STEPS (Quantity of load step precedes identifier if more than 1.)
- O = OPTION NUMBERS (may be stacked)

LOAD STEP IDENTIFIER

- A = 5 KW
- B = 10 KW
- C = 15 KW
- D = 20 KW
- E = 25 KW
- F = 50 KW
- G = 100 KW
- H = 200 KW
- J = 400 KW

OPTION IDENTIFIER

- A = 19" REMOTE CONTROL PANEL
- B = NEMA 12 ENCLOSURE FOR REMOTE CONTROL PANEL
- C = SINGLE STEP LOAD SHEDDER
- D = TWO STEP LOAD SHEDDER
- E = THREE STEP LOAD SHEDDER
- F = FOUR STEP LOAD SHEDDER
- G = OUTDOOR OPTION (W/LOUVERS)
- H = 208:120 CONTROL TRANSFORMER
- J = 240:120 CONTROL TRANSFORMER
- K = 480:120 CONTROL TRANSFORMER
- L = 600:120 CONTROL TRANSFORMER
- M = FLEXIBLE FLANGE ADAPTER DUCT (MALE)
- N = FLEXIBLE FLANGE ADAPTER DUCT (FEMALE)
- O = FLANGE ADAPTER

EXAMPLE: K711-40-36-208U-3FG-C,G

DESCRIPTION - CORE SIZE 40" H x 36" W RATED 208 V, 3-PH. UNFUSED LOAD STEPS OF THREE @ 50 KW AND ONE AT 100 KW WITH OPTIONAL SINGLE STEP LOAD SHEDDER AND LOUVERS

To calculate the minimum airflow requirement:

MINIMUM CFM REQ'D =

CORE DIMENSIONS (W" x H") x 6

To calculate Amperage: $\text{Amps} = \frac{\text{KW} \times 577}{\text{L-L Volts}}$

AVTRON MODEL K711
LOAD BANK, RESISTIVE, DUCT MOUNT
Serial Number 825 and Above

SECTION I

SAFETY CONSIDERATIONS

Throughout this manual, you will find **WARNING** and **CAUTION** statements. Personal injury to an operator using or repairing the equipment may occur if a **WARNING** statement is ignored. Damage to the equipment and potentially hazardous conditions for personnel may occur if a **CAUTION** statement is ignored.

Each Avtron unit is safety checked for opens and shorts, and the insulation is high potential tested to insure safe operation. All fuses, safety interlocks, and related safety equipment have been proven reliable as part of the testing procedure of each unit.

As part of your safety program, an initial inspection after receiving the unit(s) and periodic preventive maintenance and safety inspections should be conducted to insure the reliability and safety built into your Avtron equipment.

The Model K711 Load Bank is an industrial test unit designed to be used indoors safely. However, because of the nature of the Load Bank function (the dissipation of electrical energy), there are inherent dangers to operators and equipment. These dangers are outlined in this section.

Electrical energy is transformed into heat by the resistors. This heat must be removed from the Load Bank by the cooling blower. If there is any restriction or stoppage of airflow, the Load Bank may overheat and may even start a fire. It is recommended that:

1. The operator should read the manual before using the Load Bank.
2. Run an approved ground wire from the Load Bank ground lug, located inside the load connection area to the generator frame. Run an approved ground wire from the generator frame to a good earth ground.

Safety Considerations

3. If your unit is equipped with an airflow safety or temperature switch, do not bypass the airflow safety or temperature switch to prevent nuisance tripping. The switches drop out load if insufficient air is reaching the load elements.
4. When installing the Load Bank, do not drill into side flanges. Use only top and bottom flanges as mounting locations. Compliance with this instruction helps guard against damage to internal wiring.
5. If the unit is to be installed within existing duct work, leave enough access area to easily remove access covers on each side of the Load Bank. Special consideration should be given to mounting surface material due to hot air exhaust.
6. Maintenance personnel must always exercise caution when the access panels are removed. Personal injury from electrical shock may result if all sources of power are not disconnected before servicing. Maintenance work must be done only by qualified personnel.
7. Adequate airflow in cubic ft./min. (CFM) must be maintained at all times. (Refer to the DESCRIPTION section for minimum value of required airflow.) Failure to maintain this airflow evenly across the resistor elements may result in element burnout.
8. If duct work is vented through a screened exhaust or louvered exhaust, insure that the louvers (if motorized) are fully open when using the Load Bank. If exhausting through a screened opening, check screen periodically for any blockage.
9. After running a load test, residual heat may be removed from the Load Bank and downstream duct work by allowing the blower to operate for a few minutes after loads are removed. This procedure is not required for Load Bank integrity, but it may guard operating personnel from possible burn injuries.
10. The operator should avoid coming in contact with the resistor elements or surrounding covers during and for some time after operation. These portions of the Load Bank become quite hot and may result in a serious burn should contact be made with them.
11. Operators must not operate the Load Bank with the access panels or screens removed. To do so would expose the operator and other persons to possible personal injury from electrical shock.
12. An approved electrical fire extinguisher should be on hand at all times.

Safety Considerations

13. It is the responsibility of the customer to take diligent care in installing the Load Bank. The National Electrical Code (NEC), sound local electrical and safety codes, and the Occupational Safety and Health Act (OSHA) should be followed when installing the equipment to reduce hazards to persons and property.
14. Read and heed all **WARNING** and **CAUTION** statements in the manual.

SECTION II

DESCRIPTION AND SPECIFICATIONS

The Avtron Model K711 is designed to be used as a duct- or radiator-mounted Load Bank providing custom tailored mounting and installation. The K711 provides a resistive load rated as indicated on the Table of Contents. Minimum airflow required to cool the elements operating at full load is as indicated on the Table of Contents and must be maintained to insure safe operation of the Load Bank.

C A U T I O N

To prevent load element burnout, adequate airflow must be maintained over the entire load element area at all times voltage is applied. Insufficient air for even a few seconds will cause element burnout. This unit must have uniform airflow over the entire outlet area. If there are dead spots, damage to the elements may result.

CONTROL PANEL

The K711 Load Bank may be provided with a Control Panel as an option or the Control Panel may be customer supplied. The Control Panel may be supplied by Avtron in one of the following ways:

1. Factory installed on the side of the Load Bank without an enclosure.
2. Factory installed on the side of the Load Bank within an enclosure.
3. Factory installed within a remote mountable enclosure, separate from the Load Bank.

Description and Specifications

4. Factory supplied without an enclosure for remote mounting.

The Control Panel, when provided, serves as the manual control center for Load Bank operation. All load switches, safety indicator lights, and control circuit fuses are mounted on the panel.

When the Control Panel is not factory supplied, load application and safety circuitry are the responsibility of the customer.

Each K711 is designed with a relay compartment which contains load contactors, safety circuit components, optional load step fusing, optional control transformer with fuses, and a customer connection bus. If a Control Panel is not factory installed, the components in the relay compartment will require interconnection wiring during field installation of the Load Bank.

Interconnection wiring should conform to the National Electrical Code and any local codes.

AUTO TRANSFER SWITCH CAPABILITY

The load control circuitry is factory designed in such a way that remote operation with a customer-supplied transfer switch may be incorporated into the circuit. The factory control circuitry will be wired to a terminal board whereas a transfer switch must be enabled and connects at the terminal board per the schematic.

AUTOMATIC OPERATION

An Automatic Load Shed Controller (Controller) may be integrated into the control circuitry of the K711 Load Bank as an option. The Controller is designed to maintain a minimum load on a power source. A separately supplied current transformer provides the feedback signal required to operate the Controller. This feedback signal drives the Controller, which has field adjustable current setpoints. The Controller also incorporates field adjustable time delays to prevent repetitive load switching or initial overloading of the generator.

The Load Bank manual controls are paralleled by the automatic Controller. Automatic or manual mode may be chosen when the Load Shed option is provided with the Load Bank.

Description and Specifications

LOUVERS (OPTIONAL)

The exhaust of the Load Bank may be protected by either a stationary or motorized louver assembly.

The motorized version includes a limit switch which prevents the application of load steps if the louvers are not fully open.



ESD PRECAUTIONARY GUIDELINES



CAUTION

Certain circuit card assemblies and their components, typically integrated circuits, may be damaged by seemingly undetectable electrostatic discharge (ESD). Care must be exercised during handling/repair of these items. Use electrostatic discharge precautionary procedures.

The following guidelines are not necessarily all inclusive but rather serve as reminders for good shop practices for the handling/repair of ESD sensitive circuit card assemblies and devices.

- Store ESD sensitive items in their original containers. These items are often marked with this symbol .
- Put on a grounded wrist strap before handling any ESD sensitive item.
- Clear work area of Styrofoam^{R*}, plastic, and vinyl items such as coffee cups.
- Handle ESD items by the body, never the open edge connectors.
- Never slide ESD sensitive items over any surface.
- Transport ESD sensitive items in a static shielding container to a static-free work station.
- If a static-free work station is not available, ground the transport container before removing or inserting an ESD item.
- Electric tools used during repair should be grounded. For example, use only anti-static type solder suckers and grounded tip soldering irons. Discharge non-electric tools before use.
- Pack ESD items in static shielding containers before shipping them to Avtron for repair.

*Styrofoam^R is a registered trademark of Dow Chemical.

SECTION III

INSTALLATION

This Load Bank is designed for direct installation in a ventilation duct or on the exhaust end of a radiator. Use standard 1/4 inch hardware to mount the Load Bank to the duct or radiator. Do not extend the hardware into the Load Bank more than a maximum of 1/2 inch to insure adequate clearance between element terminations and mounting hardware. Bulletin 202 shows the proper positioning of the Load Bank in the air duct.

CAUTION

To prevent load element burnout, adequate airflow must be maintained over the entire load element area at all times voltage is applied. Insufficient air for even a few seconds will cause element burnout. This unit must have uniform airflow over the entire outlet area. If there are dead spots, damage to the elements may result.

In general, the protection provided external to the Load Bank is determined by the local codes. Since the Load Bank is generally part of an existing electrical installation, it must be protected by a fused disconnect or circuit breaker meeting all local codes.

Before making any electrical connections, the maximum phase current for the Load Bank should be determined. This may be done using the following formula.

$$I_{\text{PHASE}}(\text{MAX}) = \frac{\text{KW} \times 577}{V (\text{Line-to-Line})}$$

Installation

C A U T I O N

When installing the Load Bank, do not drill into side flanges. Use only top and bottom flanges as mounting locations. Compliance with this instruction helps guard against damage to internal wiring.

The electrical connections necessary for proper operation of the Load Bank are as follows:

1. Connect the load power source as indicated on the Schematic/ Interconnection Diagram.
2. A ground connection must be made to the Load Bank (GND terminal) to prevent injury to personnel. This may be accomplished by a ground wire connected directly to the Load Bank ground stud provided in the control box. This ground wire should be connected to the frame of the generator under test. The generator frame should be grounded to a good earth ground.
3. Make control circuit connections as required using #14 AWG wire minimum. Refer to the Schematic Diagram found at the end of this manual for the required control voltage. For conduit runs greater than 50 feet, consult the factory.
4. When an automatic Controller is included with the Load Bank, installation of the current transformer on the main power bus as shown in Figure 3-1 is required. Wire the current transformer into the control circuitry as shown on the provided schematic.

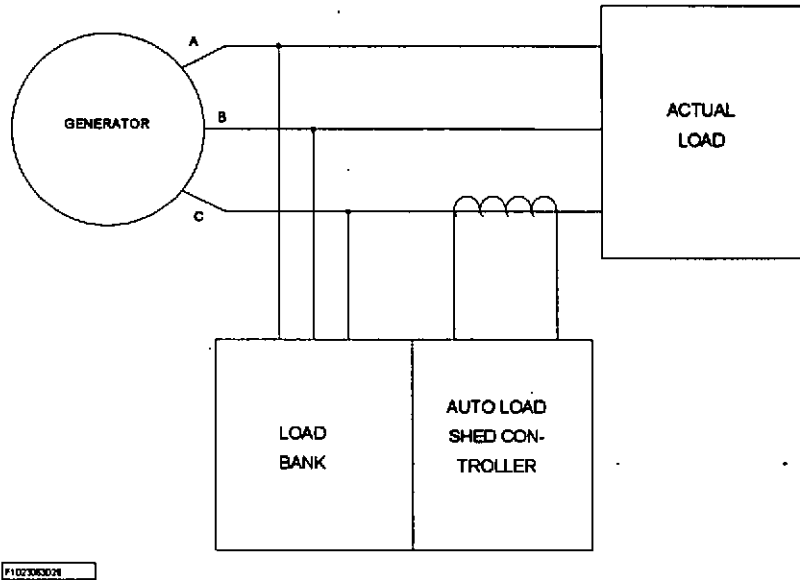

Figure 3-1

W A R N I N G

Always put a short or shunt across the current transformer when servicing the Load Bank. Primary current flowing through an unshunted current transformer will destroy the transformer with possible harm to personnel.

Never allow the secondary of the current transformer to remain disconnected when primary current is passing through the transformer. If the Load Bank must be disconnected, put a short or shunt across the current transformer.

NOTE

Before placing the system into AUTO, place the Load Bank load step switch(es) to the OFF position.

OPTIONAL CONTROLLER OPERATION AND ADJUSTMENTS

W A R N I N G

Always put a short or shunt across the current transformer when servicing the Automatic Load Shed Controller. Primary current flowing through an unshunted current transformer will destroy the transformer with possible harm to personnel.

Before the current setpoint(s) can be adjusted, the operator must determine the maximum load the Controller should maintain (generally 60% to 80% of the total generator KVA).

SETPOINT CALCULATION (Example)

1. Generator Rating = 15 KVA at 240 VAC, 62.5 Amps
2. Setpoint Value (approximately 60% of Full Load)

$$\begin{aligned} \text{Setpoint} &= 15 \times 0.6 = 9 \text{ KW} \\ 9 \text{ KW at } 240 \text{ V} &= 37.5 \text{ Amps} \end{aligned}$$

TRIP POINT ADJUSTMENTS

There are three methods of field adjusting the trip point of the current sensing relays:

- Method 1 - Using generator load power
- Method 2 - Using a separate (0-5 Amp) current source without the current transformer
- Method 3 - Rough adjustment (Approximation Method)

Installation

METHOD 1 - Using the Actual Generator Load Power

This method uses the load current to set the current setpoint(s).

1. Apply 120 VAC, 60 Hz control power. (See schematic.) Place AUTO/MANUAL switch to MANUAL.

W A R N I N G

There is lethal high voltage present within the Controller enclosure; care must be taken when proceeding from this point.

2. On the Controller, turn the adjustable potentiometer, labeled LEVEL PERCENT, down to its lowest setting.
3. Energize the system while on line. Refer to the OPERATION instructions in Section IV.

NOTE

Always monitor the generator load with external metering so as not to overload the generator.

4. Adjust the generator load until the load equals the desired setpoint. The Load Bank can be used manually to achieve the desired load current if the current transformer is relocated to sense both building load and Load Bank load. Otherwise use actual building load.

NOTE

On the Controller, there is an LED indicator for each channel (Output). When lit, the channel is energized.

Channel 1 (LED CR13)
Channel 2 (LED CR17)
Channel 3 (LED CR21)
Channel 4 (LED CR25)
Channel 5 (LED CR29)

Installation

Turn the adjustable potentiometer, labeled LEVEL PERCENT, past the trip point (completely counterclockwise; LED is off). Then turn slowly clockwise until the channel trips on (LED is on).

METHOD 2 - Using a separate (0-5 Amp) Current Source without Current Transformer

1. Disconnect all sources of power to the Automatic Load Shed Controller.

W A R N I N G

When disconnecting the current transformer, the secondary terminals must be shorted. The secondary of an unshorted current transformer can exceed several thousand volts.

2. Apply 120 VAC, 60 Hz control power. (See schematic.)

W A R N I N G

There is lethal high voltage within the control enclosure.

3. Using a controlled current source, apply the setpoint current (from secondary current calculation) to Controller terminals J1-1 and J1-2.
4. Turn the adjustable potentiometer, labeled LEVEL PERCENT, counterclockwise past the trip point; then decrease until the channel trips on, indicated by LED turning on.

Installation

METHOD 3 - Rough Adjustment

Use the following formula to calculate the percentage C.T. Tap chosen to operate the P.C. Board:

$$\% \text{ Dial Setting} = \text{Setpoint/C.T. Tap}$$

**INSTALLATION CHECKOUT PROCEDURE -
TO BE DONE PRIOR TO OPERATION**

This Installation Checkout Procedure is intended to be used upon initial receipt of equipment and following any relocation of a permanent mounted Load Bank. These procedures apply to Load Banks in general and may include steps not relevant to the specific unit being installed. Disregard those procedures which do not apply.

W A R N I N G

THE FOLLOWING TESTS ARE TO BE ACCOMPLISHED BY A QUALIFIED ELECTRICIAN OR TECHNICIAN USING EXTREME CAUTION AS POTENTIALLY LETHAL VOLTAGES AND DANGEROUS ROTATING COMPONENTS ARE PRESENT. IF ASSISTANCE IS REQUIRED, AVTRON CAN PROVIDE START UP SERVICE AT A NOMINAL CHARGE. AVTRON ALSO WILL PROVIDE TELEPHONE ASSISTANCE IF REQUIRED BY CALLING (216) 641-8310.

1. Verify the Load Bank placement meets the installation requirements found in the Installation section of the instruction manual:
 - A. Check the clearance from both intake and exhaust to any obstruction.
 - B. If the location has a prevailing wind, make the wind aid in the cooling of the resistor elements.
 - C. If the Load Bank is elevated, a plate under the Load Bank will be needed to block hot exhaust from returning to the intake.

Installation

2. Check the mechanical integrity of all customer-supplied interconnection wiring:
 - A. Check lugs that they are properly crimped.
 - B. Check terminations that they are properly torqued.
3. Utilize system schematics to ohm out customer-supplied interconnection control wiring and safety circuits:
 - A. If control wiring is all the same color, ohm out each individual wire to confirm proper labeling and placement.

C A U T I O N

Control wiring must be a minimum of 14 AWG for wire runs under 50 feet. Consult Avtron factory for wire sizing when wire run exceeds 50 feet.

- B. Confirm the correct wire gauge has been used for interconnection wiring. Control wiring should be a minimum of 14 AWG for control panel to Load Bank lengths of 50 feet or less. For lengths greater than 50 feet, consult the factory.
- C. If a Control Transformer is the source of control power, disconnect the control transformer before proceeding.

C A U T I O N

When control power is supplied by a transformer within the Load Bank, it must be disconnected before running this installation checkout procedure. Failure to disconnect the control transformer may damage the Load Bank.

4. Energize the source of control power only. Check the control voltage and confirm it is within 10% of the required voltage.

Installation

W A R N I N G

Control power is present on terminal block in steps 4 through 6.

5. Verify the proper relays energize with each individual load switch.
 - A. Turn on each load step individually and observe that each relay or relays pulls in without chatter or hesitation.
 - B. Turn off the master load switch. Turn on all the load steps. Turn the master load on and observe the pull in of all the contactors. If chatter or hesitation is observed, locate the cause of the voltage drop causing the problem.
6. Apply the rated fan voltage. Start blower and verify that air is exiting the resistor assembly end.

This checkout procedure is intended to be a guide to Load Bank installations in general. Special installation considerations not addressed herein may be necessary due to installation site or environment. Any questions or concerns regarding Load Bank installation should be directed to Avtron Field Service at (216) 641-8310.

SECTION IV

OPERATION

C A U T I O N

DO NOT operate the Load Bank over the rated voltage as this will cause a catastrophic failure in the Load Bank.

DO NOT apply DC voltages to the Load Bank because the contactors do not have arc blowout magnets.

To prevent load element burnout, adequate airflow must be maintained over entire load element area at all times voltage is applied. Insufficient air for even a few seconds will cause element burnout.

It is important to note that if the generator is removed, the control circuit may still be energized if control power is not removed. Therefore, before removing cover, make certain all sources of power to the Load Bank are disconnected.

The K711 Load Bank may be operated in a manual mode or, if the Load Shedder option is provided, in an automatic mode. Operation instructions for the different modes are as follows:

1. Manual Operation - K711 units without a Control Panel.
2. Manual Operation - K711 units with a Control Panel included as an option.
3. Automatic Operation - K711 units with the Load Shedder option.

Operation

Take note that in cases where the K711 Load Bank is provided with the transfer switch option, to permit load application, the terminal board terminals referenced on the schematic for this application must be connected either by a hard wired jumper or a closed transfer switch contact.

MANUAL OPERATION (for K711 units without a Control Panel)

After mounting the K711, connecting 120 V control power, and running interconnecting control wires per the schematic:

1. Check to confirm that all load contactors will not be energized prematurely.
2. Connect generator or other source to be tested to the Load Bank as described in the INSTALLATION section.
3. Apply power to the control circuit. (If Load Bank has motorized louvers, verify louvers are open prior to the initiation of airflow.)
4. Start power source under test. Be sure air is flowing over resistance elements.
5. Apply load to the power source by energizing load contactors.
6. Shutdown - After running a load test, residual heat may be removed from the Load Bank and downstream duct work by allowing the blower to operate for a few minutes after loads are removed. This procedure is not required for Load Bank integrity, but it may guard operating personnel from possible burn injuries.

MANUAL OPERATION (for K711 units with a Control Panel included as an option)

After mounting the K711, connecting 120 V control power, and running interconnecting control wires per the schematic:

1. Place all switches on the Control Panel to the OFF position.
2. Place AUTO/MANUAL switch to MANUAL. (This step only applies to Load Banks with Load Shedder option.)
3. Connect the generator or other power source to be tested to the Load Bank as described in the INSTALLATION section.

Operation

4. Place the POWER switch to the ON position. The POWER light will be energized indicating control power is present. (If Load Bank has motorized louvers, verify louvers are open prior to the initiation of airflow.)
5. With the MASTER LOAD switch in the OFF position, start the generator under test. Using a customer-supplied blower, be sure air is flowing over the resistance elements.
6. The resistive loading is selected by load step switches, using any one or a combination to make up a given load.
7. Apply load to the power source by moving the MASTER LOAD switch to the ON position.
8. Any load can be added or removed during MANUAL testing provided the MASTER LOAD switch is on.
9. To remove all loads, move MASTER LOAD switch to the OFF position.
10. Shutdown - Place all switches in the OFF position. After running a load test, residual heat may be removed from the Load Bank and downstream duct work by allowing the blower to operate for a few minutes after loads are removed. This procedure is not required for Load Bank integrity, but it may guard operating personnel from possible burn injuries.

AUTOMATIC OPERATION (for K711 Load Banks with Load Shedder option)

After mounting the K711 and connecting 120 V control power per the schematic:

1. Place all switches on the Control Panel to the OFF position.
2. Connect the generator or other power source to be tested to the Load Bank as described in the INSTALLATION section.
3. Place the POWER switch to the ON position. The POWER light (DS1) will be energized, indicating control power is present. (If Load Bank has motorized louvers, verify louvers are open prior to the initiation of airflow.)
4. Place AUTO/MANUAL switch to AUTO.
5. Start the generator under test. Using a customer-supplied blower, be sure air is flowing over the resistance elements.

Operation

6. When the Auto Transfer Contact is open, the Auto Load Shedder will be active. As the load on the generator lessens, the Load Shed Controller will automatically apply load steps until the overall generator load exceeds the minimum setpoint. The Load Shed Controller automatically removes load steps when the generator load exceeds the maximum setpoint.

DRAWINGS

PROPRIETARY NOTE

The wiring diagrams and schematics which follow contain information PROPRIETARY to Avtron Manufacturing, Inc.; are furnished solely to provide information sufficient for instruction, operation, maintenance, evaluation, and testing of the equipment herein disclosed; are not to be used for manufacturing or procurement; and are not to be disclosed to anyone other than persons in the Division, or the Company, or the Government, as the case may be, responsible for action relating to this document without the express written permission of Avtron Manufacturing, Inc.

CUSTOMER CONNECTION TERMINALS
DIRECTLY TO LOAD ELEMENTS
FOR INTERCONNECTION TO LOAD
STEP CONTACTORS IN REMOTE CABINET

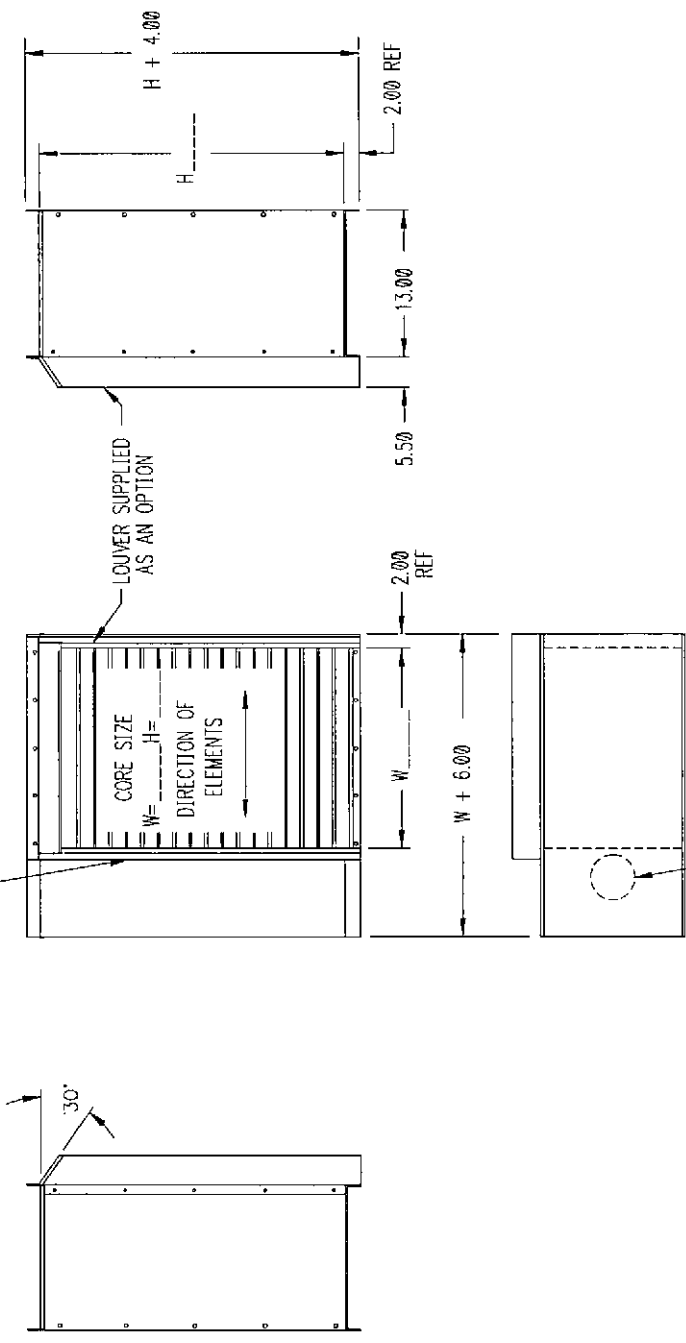

CONDUIT ENTRANCE FOR INTERCONNECTION
TO REMOTE CABINET SECTION
TO BE DRILLED BY CUSTOMER

FOR APPLICATION ENGINEERING USAGE ONLY

DATE	3/15/96	AVTRON MANUFACTURING, INC. INDUSTRY DIV.	DRAWING NUMBER	SB2588
DRAWN	Derrin		LOAD BANK K71B	SHEET 1 OF 2
CHECKED			LOAD ELEMENT SECTION	OUTLINE DRAWING
APPROVED	BOHRER	NONE		
ECN NO.	REV NO.	LET.	CHANGE	CHK'D

2. ALL DIMENSIONS ARE APPROX.
1. WEIGHT: VARIES BETWEEN 100 & 500 LBS

NOTES:

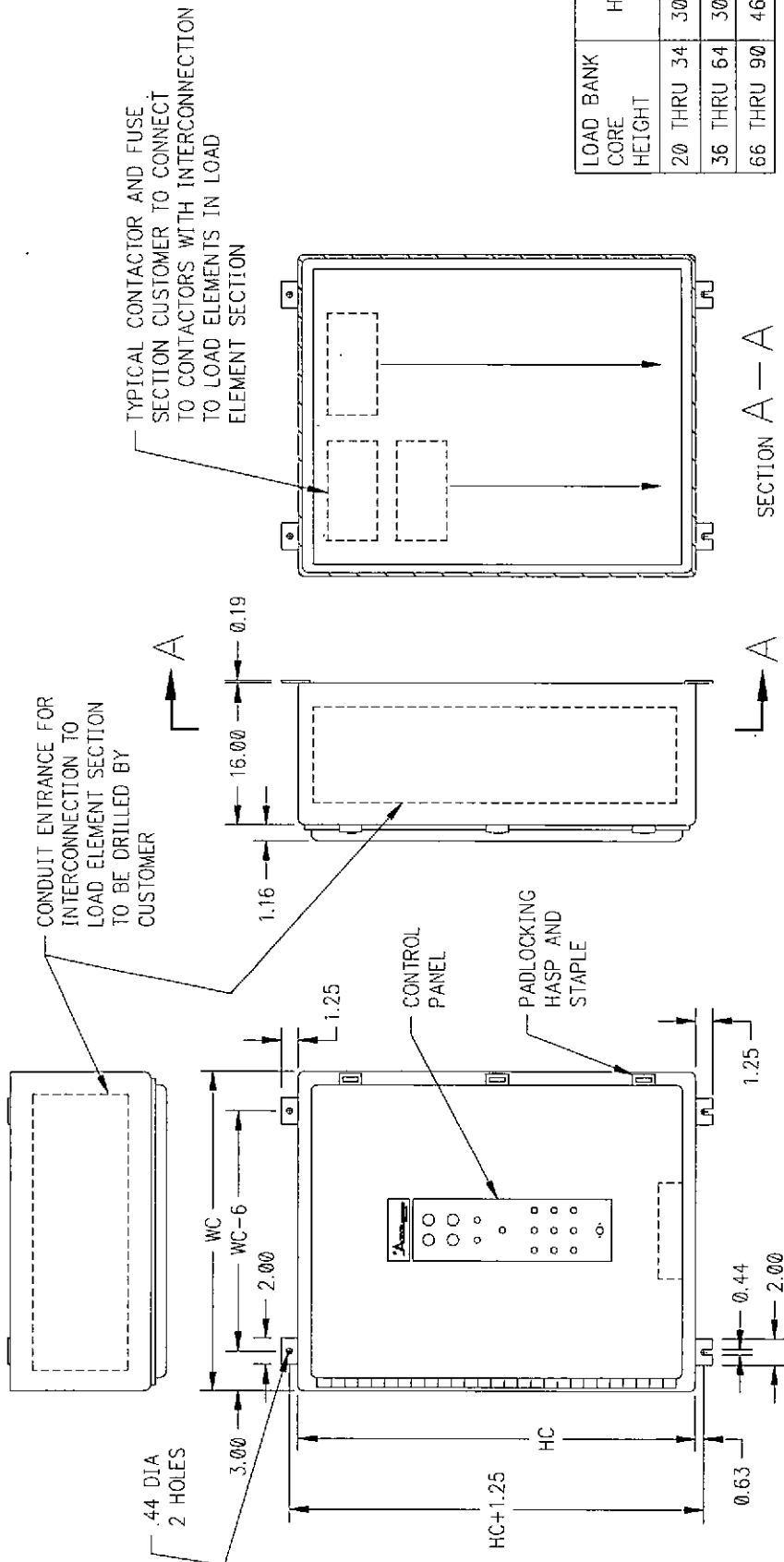

LOAD BANK CORE HEIGHT	HC	WC
20 THRU 34	30.00	24.00
36 THRU 64	30.00	36.00
66 THRU 90	46.00	36.00

FOR APPLICATION ENGINEERING USAGE ONLY

DRAWN: Derrin 3/15/96		DATE: 3/15/96		DRAWING NUMBER: SB2588	
CHECKED:	APPROVED: BOHRER	SCALE: NONE	*AVTRON MANUFACTURING, INC. LOAD BANK K711B REMOTE CABINET SECTION		
E.C.N. REV. NO. / LET.		CHANGE	CH'D	CH'D	SHEET 2 OF 2 OUTLINE DRAWING

- NOTES:
- 3 - NEMA 12 ENCLOSURE, SINGLE DOOR, WALL MOUNTED.
 - 2 - ALL DIMENSIONS ARE APPROX.
 - 1 - WEIGHT: VARIES BETWEEN 100 & 500 LBS

ECN NO.	REV.	DESCRIPTION	DATE	APPROVED
00545	A	REVISED PER ECN	1/13/81	ARMAGOST
00545	B	REVISED PER ECN	7/29/81	HURDSON
00545	C	REVISED PER ECN	9/23/81	HURDSON
00545	D	REVISED PER ECN	12/22/81	K.KOJK
00545	E	AUTO/MAN SWITCH, DS50 WAS: DS20	12/22/81	K.KOJK

AUTO TRANSFER CONTACT (N.O. FOR AUTO OPERATION)

TO POWER DISTRIBUTION BLOCK

THIS DOCUMENT CONTAINS PROPRIETARY INFORMATION OF AVIRON MFG. INC. AND MAY NOT BE DISCLOSED TO OTHERS OR USED FOR MANUFACTURING PURPOSES WITHOUT THE WRITTEN CONSENT OF AVIRON MFG.

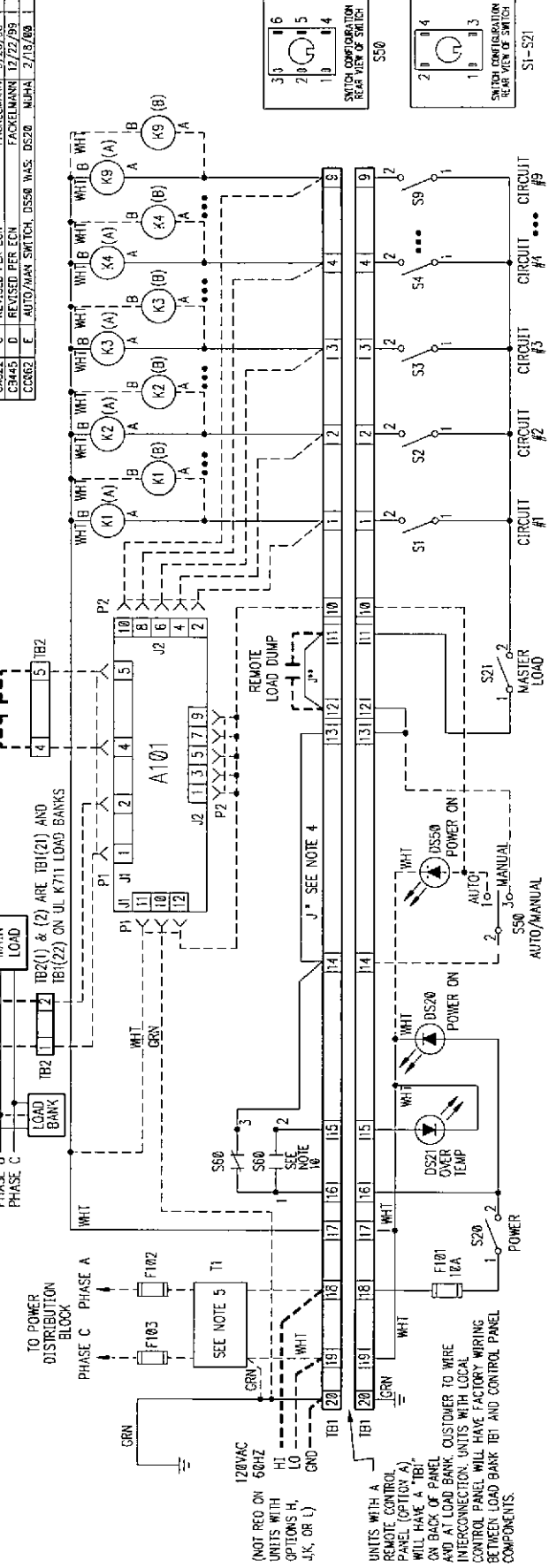

ITEM NO.	QUANTITY	DESIGNATION	DESCRIPTION	PART NO.	ITEM NO.	QUANTITY	DESIGNATION	DESCRIPTION	PART NO.
1	1	S1-21	SWITCH, TOGGLE	360589	19	N/A			
2	1	S50	SWITCH, TOGGLE	360591	18	N/A			
3	1	A101	PC BOARD ASSY, LOAD SHED	A22829	14	N/A			
4	1	P1,P2	CONNECTOR, SOCKET	364457	13	N/A			
5	1	S60	SWITCH, TEMPERATURE	360379	12	N/A			
6	1	TB2	TERMINAL BOARD	364054	11	N/A			
7	1	TB1	TERMINAL BOARD	364103	10	N/A			
8	1	DS20	LIGHT, INDICATOR (GREEN)	329715	7	N/A			
9	1	DS21	LIGHT, INDICATOR (RED)	329714	6	N/A			
10	1	XF101	FUSEHOLDER	325022	5	N/A			
11	1	XF102	FUSEBLOCK	324615	4	N/A			
12	1	F101	FUSE	324128	3	N/A			
13	1	F102	FUSE	324454	2	N/A			
14	1	T1	TRANSFORMER	370884	1	N/A			
15	1	S20	SWITCH, TOGGLE	360589	19	N/A			
16	1	S50	SWITCH, TOGGLE	360591	18	N/A			
17	1	A101	PC BOARD ASSY, LOAD SHED	A22829	14	N/A			
18	1	P1,P2	CONNECTOR, SOCKET	364457	13	N/A			
19	1	S60	SWITCH, TEMPERATURE	360379	12	N/A			
20	1	TB2	TERMINAL BOARD	364054	11	N/A			
21	1	TB1	TERMINAL BOARD	364103	10	N/A			
22	1	DS20	LIGHT, INDICATOR (GREEN)	329715	7	N/A			
23	1	DS21	LIGHT, INDICATOR (RED)	329714	6	N/A			
24	1	XF101	FUSEHOLDER	325022	5	N/A			
25	1	XF102	FUSEBLOCK	324615	4	N/A			
26	1	F101	FUSE	324128	3	N/A			
27	1	F102	FUSE	324454	2	N/A			
28	1	T1	TRANSFORMER	370884	1	N/A			
29	1	S20	SWITCH, TOGGLE	360589	19	N/A			
30	1	S50	SWITCH, TOGGLE	360591	18	N/A			
31	1	A101	PC BOARD ASSY, LOAD SHED	A22829	14	N/A			
32	1	P1,P2	CONNECTOR, SOCKET	364457	13	N/A			
33	1	S60	SWITCH, TEMPERATURE	360379	12	N/A			
34	1	TB2	TERMINAL BOARD	364054	11	N/A			
35	1	TB1	TERMINAL BOARD	364103	10	N/A			
36	1	DS20	LIGHT, INDICATOR (GREEN)	329715	7	N/A			
37	1	DS21	LIGHT, INDICATOR (RED)	329714	6	N/A			
38	1	XF101	FUSEHOLDER	325022	5	N/A			
39	1	XF102	FUSEBLOCK	324615	4	N/A			
40	1	F101	FUSE	324128	3	N/A			
41	1	F102	FUSE	324454	2	N/A			
42	1	T1	TRANSFORMER	370884	1	N/A			
43	1	S20	SWITCH, TOGGLE	360589	19	N/A			
44	1	S50	SWITCH, TOGGLE	360591	18	N/A			
45	1	A101	PC BOARD ASSY, LOAD SHED	A22829	14	N/A			
46	1	P1,P2	CONNECTOR, SOCKET	364457	13	N/A			
47	1	S60	SWITCH, TEMPERATURE	360379	12	N/A			
48	1	TB2	TERMINAL BOARD	364054	11	N/A			
49	1	TB1	TERMINAL BOARD	364103	10	N/A			
50	1	DS20	LIGHT, INDICATOR (GREEN)	329715	7	N/A			
51	1	DS21	LIGHT, INDICATOR (RED)	329714	6	N/A			
52	1	XF101	FUSEHOLDER	325022	5	N/A			
53	1	XF102	FUSEBLOCK	324615	4	N/A			
54	1	F101	FUSE	324128	3	N/A			
55	1	F102	FUSE	324454	2	N/A			
56	1	T1	TRANSFORMER	370884	1	N/A			
57	1	S20	SWITCH, TOGGLE	360589	19	N/A			
58	1	S50	SWITCH, TOGGLE	360591	18	N/A			
59	1	A101	PC BOARD ASSY, LOAD SHED	A22829	14	N/A			
60	1	P1,P2	CONNECTOR, SOCKET	364457	13	N/A			
61	1	S60	SWITCH, TEMPERATURE	360379	12	N/A			
62	1	TB2	TERMINAL BOARD	364054	11	N/A			
63	1	TB1	TERMINAL BOARD	364103	10	N/A			
64	1	DS20	LIGHT, INDICATOR (GREEN)	329715	7	N/A			
65	1	DS21	LIGHT, INDICATOR (RED)	329714	6	N/A			
66	1	XF101	FUSEHOLDER	325022	5	N/A			
67	1	XF102	FUSEBLOCK	324615	4	N/A			
68	1	F101	FUSE	324128	3	N/A			
69	1	F102	FUSE	324454	2	N/A			
70	1	T1	TRANSFORMER	370884	1	N/A			
71	1	S20	SWITCH, TOGGLE	360589	19	N/A			
72	1	S50	SWITCH, TOGGLE	360591	18	N/A			
73	1	A101	PC BOARD ASSY, LOAD SHED	A22829	14	N/A			
74	1	P1,P2	CONNECTOR, SOCKET	364457	13	N/A			
75	1	S60	SWITCH, TEMPERATURE	360379	12	N/A			
76	1	TB2	TERMINAL BOARD	364054	11	N/A			
77	1	TB1	TERMINAL BOARD	364103	10	N/A			
78	1	DS20	LIGHT, INDICATOR (GREEN)	329715	7	N/A			
79	1	DS21	LIGHT, INDICATOR (RED)	329714	6	N/A			
80	1	XF101	FUSEHOLDER	325022	5	N/A			
81	1	XF102	FUSEBLOCK	324615	4	N/A			
82	1	F101	FUSE	324128	3	N/A			
83	1	F102	FUSE	324454	2	N/A			
84	1	T1	TRANSFORMER	370884	1	N/A			
85	1	S20	SWITCH, TOGGLE	360589	19	N/A			
86	1	S50	SWITCH, TOGGLE	360591	18	N/A			
87	1	A101	PC BOARD ASSY, LOAD SHED	A22829	14	N/A			
88	1	P1,P2	CONNECTOR, SOCKET	364457	13	N/A			
89	1	S60	SWITCH, TEMPERATURE	360379	12	N/A			
90	1	TB2	TERMINAL BOARD	364054	11	N/A			
91	1	TB1	TERMINAL BOARD	364103	10	N/A			
92	1	DS20	LIGHT, INDICATOR (GREEN)	329715	7	N/A			
93	1	DS21	LIGHT, INDICATOR (RED)	329714	6	N/A			
94	1	XF101	FUSEHOLDER	325022	5	N/A			
95	1	XF102	FUSEBLOCK	324615	4	N/A			
96	1	F101	FUSE	324128	3	N/A			
97	1	F102	FUSE	324454	2	N/A			
98	1	T1	TRANSFORMER	370884	1	N/A			
99	1	S20	SWITCH, TOGGLE	360589	19	N/A			
100	1	S50	SWITCH, TOGGLE	360591	18	N/A			

- 7 - ALL WIRING TO BE #18AWG (P/M 3900000). ALL WIRING TO BE BLACK UNLESS NOTED OTHERWISE.
- 8 - T1, F102, TB3 ARE USED ONLY FOR UNITS WITH OPTIONS H, J, K OR L. S50, DS50, TB2 & A101 ARE USED ONLY FOR UNITS WITH OPTIONS C, D, E OR F.
- 9 - FOR 208V UNITS FOR 600V UNITS 550VA FOR 240V UNITS 550VA
- 10 - FOR 480V UNITS 550VA
- 11 - REMOVE THIS WIRE TO ALLOW AUTO OPERATION. (ON UNITS WITH OPTIONS C, D, E OR F)
- 12 - REMOVE THIS WIRE FOR LOAD DUMP OPERATION.
- 13 - DASHED LINES INDICATE OPTIONAL WIRING.
- 14 - BOLD DASHED LINES INDICATE CUSTOMER WIRING.
- 15 - N/A = NOT AVAILABLE
- 16 - PRESET R14, R26, R38, R52, R65 & R78 TO 3 SEC.
- 17 - PRESET R21, R34, R47, R60 & R73 PER C.A.N. (CUSTOMER REQUIREMENTS).

UNLESS OTHERWISE SPECIFIED THE ABOVE NOTES APPLY

LIST OF MATERIAL

SCALE NONE MODEL K711 SHEET 1 OF 1

AVIRON MANUFACTURING CORPORATION, OH 44131-5529

SCHEMATIC/WIRING DIAGRAM

208V, 240V, 480V, 600V

DATE 9/27/96

DWG NO. 01014

REV C

ITEM NO. 208V

PART NO. 240V

DESIG. 480V

208V

Since the load banks absorb 100% of their rating as soon as voltage is applied regardless of air flow, it is necessary to install them properly to prevent damage or malfunctions. Outlined below are some practices which should be followed.

- AIR FLOW** - The air flow through all sections of the load bank should be at least 800 ft/min. and preferably 1000 ft/min. or greater. The air flow should not be blocked from some sections of the load bank or the load bank installed so there are areas of "dead" air. See Bulletin 203 for method of air flow computation.

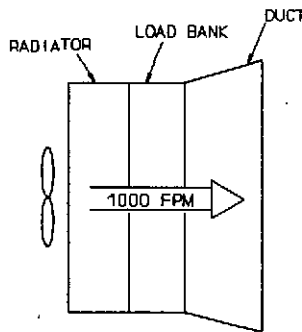

RIGHT

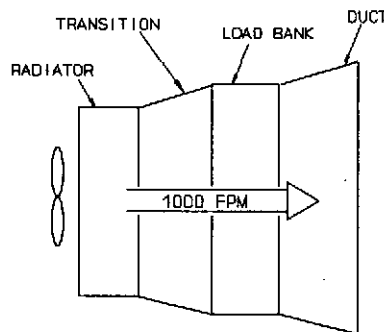

RIGHT

(PREFERRED IF OVERSIZED
 LOAD BANK IS REQUIRED)

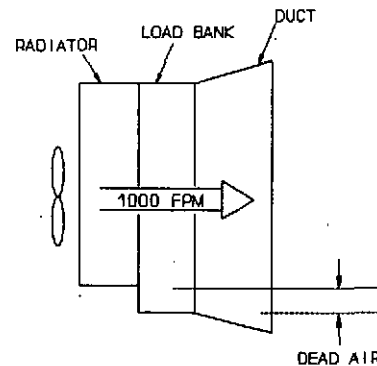

WRONG

- THERMAL PROTECTORS** - When thermal protectors are included as a part of the unit, the load bank should always be installed with the thermal protector at the top.

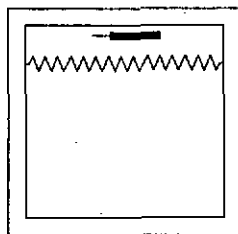

RIGHT

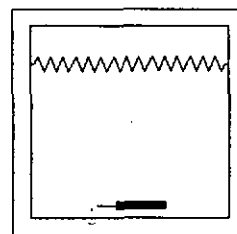

WRONG

I. AIRFLOW CALCULATIONS

Load Banks are designed to operate with air passing over the load elements at a rate of approximately 1,000 ft./min. (5.08 meters/sec.). They will withstand higher air velocity without any problems as far as the Load Bank is concerned; however, the pressure drop across the Load Bank will increase. Therefore, this must be considered when selecting a Load Bank. When the air velocity is a great deal less than 1,000 ft./min., the load elements will operate at a higher temperature, which results in shorter life. At very low air velocity, the elements will overheat and be destroyed.

Outlined below are simple methods of computing air velocity, pressure drop, and temperature rise for the Avtron K711 series duct type Load Banks.

A. AIR VELOCITY COMPUTATIONS

When selecting a duct type Load Bank, the engine radiator parameters such as size and airflow are known. The Load Bank frame with dimensions closest to the effective dimensions of the radiator should be considered. For a given engine configuration, the airflow in cubic feet per minute or liters per second is supplied by the engine manufacturer. The velocity is calculated by using the effective area of the Load Bank and the engine airflow.

$$\text{Velocity (Ft. per Min.)} = \frac{\text{Engine Airflow (cu. ft./min.)} \times 144}{\text{Load Bank Width (in) Load Bank Height (in)}}$$

$$\text{Velocity (meters/sec.)} = \frac{\text{Engine Airflow (Liters/Sec.)} \times 10}{\text{Load Bank Width (cm) Load Bank Height (cm)}}$$

B. PRESSURE DROP

The Avtron K711 series of Load Banks are designed to be compatible with typical radiator sizes and airflows. One important criterion in application of the Load Banks is the air pressure drop through the Load Bank. The engine generator sets are usually designed with sufficient fan capacity to provide a head of .5 in. H₂O (12.7mm H₂O) after the air has passed through the radiator. The Load Banks are designed to minimize the cooling air pressure drop. Typically, the louver type Load Banks have a pressure drop of about .2 in. H₂O (5.08mm H₂O) and the duct types have a drop of about .1 in. H₂O (2.54mm H₂O) at minimum rated airflow.



C. AIR TEMPERATURE RISE

In some installations, the allowable exhaust air temperature from the overall engine generator and Load Bank combination must be limited to a specific value. The temperature rise information on the engine generator combination can be supplied by the manufacturer. The air temperature rise through the Load Bank can be calculated from the following formula:

$$\text{Temp Rise (° F)} = \frac{\text{Load Bank KW} \times 3200}{\text{CFM}}$$

$$\text{Temp Rise (° C)} = \frac{\text{Load Bank KW} \times 570}{\text{Liters/Sec.}}$$

Depending on the installation, the cooling system exhaust air temperature rise may be compiled using the Load Bank temperature rise derived from the above calculation and adding it to the other system temperature rises.

II. ELECTRICAL CALCULATIONS

A. RATING

The Load Bank power ratings are based on the highest rated operating voltage. Each load step consists of two elements, each rated at 138 volts connected in wye. When connected in the series configuration, the Load Bank may be used on 480 V or 380 V, 3 Phase. With 480 volts applied to the terminals, 138 volts is applied to each element. When connected in parallel configuration, the Load Bank may be used on 240 V or 208 V, 3 Phase systems. With 240 V, 3 Phase applied to the terminals, 138 volts is applied to each element. The load absorbed by the Load Bank at other than rated voltage can be computed from the formula:

$$\text{Absorbed KW} = \frac{\text{Rated KW} \times (\text{Applied Voltage})^2}{(\text{RATED VOLTAGE})^2}$$

For example, a 100 KW Load Bank connected for 240 volts with 208 volts applied will absorb 75 KW.

$$\text{Absorbed KW} = \frac{100 \times (208)^2}{(240)^2}$$

B. CURRENT CALCULATIONS

To determine the wire size and fuse ratings for a given installation, it is necessary to determine the line current. This can be readily determined from the formula:

$$\text{Phase Current} = \frac{\text{Absorbed KW} \times 577}{\text{Applied Voltage (Line-to-Line)}}$$

For example, a 100 KW load with 480 volts applied will draw 120 amperes per phase.

$$\text{Phase Current} = \frac{100 \times 577}{480}$$

C. REACTIVE LOAD CALCULATIONS

When engine generator sets are operated with Resistive (KW) load, they are being tested at unity (1.0) Power Factor. Some load tests require operation at lower power factors, usually .8 PF. To perform these tests requires a load with both Resistive (KW) and Reactive (KVAR) capability. The Resistive and Reactive parts of the total load add vectorially, not directly. For example, to load a 100 KW generator at .8 Power Factor requires a Resistive load with a capacity of 100 KW and a Reactive load of 75 KVAR. The total load (Resistive and Reactive) on the generator is expressed as Volt-Amperes (KVA) and is the product of current times voltage. Using the above example of 100 KW Resistive load and 75 KVAR Reactive load, the total load (KVA) on the generator is 125 KVA.

When the generator set rating is expressed in terms of Resistive load at a certain power factor (100 KW at .8 PF), the total load (KVA) and Reactive load (KVAR) can be calculated as outlined below.

$$\text{Total Load (KVA)} = \frac{\text{Resistive Load (KW)}}{\text{Power Factor}}$$

$$\text{KVA} = \frac{100}{.8} = 125$$



$$\begin{aligned}\text{Reactive Load} &= \sqrt{(\text{KVA})^2 - (\text{KW})^2} \\ &= \sqrt{(125)^2 - (100)^2} \\ &= \sqrt{15625 - 10000} \\ &= \sqrt{5625} = 75 \text{ KVAR}\end{aligned}$$

Warranty

Warranty and Duration

For a period of one year after installation, or fifteen (15) months from date of shipment from our plant, whichever is shorter, Avtron warrants the equipment, except as hereinafter provided, to be free from harmful defects in material and workmanship. Notwithstanding any other term or provision in this Warranty, the warranty provided herein shall terminate unless buyer notifies Avtron, in writing, of a breach hereof within the warranty period; any claims not made within such period are waived by Buyer. The warranty provided herein applies only if Buyer complies with all the other terms and provisions of this Warranty.

Uses of Equipment

The warranty provided herein applies only if the equipment has been used in a normal and proper manner under recommended conditions. Notwithstanding any advice or assistance given to the Buyer by Avtron or its suppliers concerning the equipment or its use, Avtron makes no express or implied warranties or representations, except as herein expressly provided, with respect to the equipment or its use, and Avtron shall not be liable in contract, warranty or tort (including, without limitation, for negligence or strict liability) as a result of such advice or assistance. In addition, unless otherwise agreed in writing signed by a duly authorized representative of Avtron, no equipment covered by this warranty is intended to be used in connection with any nuclear facility or activity, and if so used, Avtron disclaims any and all liability for any damage resulting therefrom.

Notification of Breach

When claiming a breach of this Warranty, Buyer must promptly (within 10 days from the date of the discovery of the defect) notify Avtron in writing.

Equipment Disposition

Upon notification of a claimed breach of this Warranty, Avtron, at its discretion, will either authorize the return of the defective equipment or part thereof (transportation costs to be prepaid by Buyer) or provide a suitable replacement or authorize the Buyer in writing to effect repairs at Avtron's expense. In the event that the equipment returned as authorized is found to be defective and Avtron elects to repair or replace said equipment, Avtron will pay the transportation costs associated with the return of said equipment to Buyer. Avtron shall not however be liable for any customs, tariffs, duties or taxes incurred in shipping equipment pursuant to this Warranty. These shall be the responsibility of the Buyer.

Option of Avtron to Repair or Replace Equipment or to Issue Credit

Avtron's sole obligation under this Warranty shall be, at the option of Avtron, to replace or repair any defective equipment or part thereof or to issue a credit with respect to the defective equipment equal to the purchase price thereof less depreciation.

Equipment Excluded From Warranty

The warranty provided herein specifically excludes equipment and components that Avtron purchases and resells as part of a system, product or spare part order. The warranties provided to Avtron by the manufacturers of the foregoing equipment and components will, to the extent possible, be passed on to the Buyer. Copies of such warranties, if on file at Avtron, will be made available for inspection upon the request of Buyer. Equipment such as, but not limited to, computers, CRTs, operator interface modules, monitors, etc., normally have a short warranty period and should be covered by a continuous service contract generally available from the original manufacturer at a reasonable cost. Consumable items including, but not limited to, lamps, filters, fuses and motor brushes are excluded from all warranties. Other items or components may be excluded from this warranty if so noted in the governing purchase order or contract.

Resale or Lease of Equipment

In the event that the Buyer resells or leases equipment purchased from Avtron, the Buyer shall obtain the signed written agreement of the purchaser or lessee thereof that Avtron's only liability with respect to said equipment is as set forth in this Warranty. In the event that the Buyer fails to obtain such a signed written agreement, the Buyer agrees to indemnify Avtron against any claims, demands, judgments, suits, costs, liabilities and expenses (including reasonable attorney's fees) incurred by Avtron as a result of such failure.

Unauthorized Repairs

Unless otherwise agreed in writing signed by a duly authorized representative of Avtron, if the Buyer has repairs or modifications made to equipment covered by this Warranty by a person other than an authorized Avtron service representative, Avtron shall not be liable for any expenses incurred in connection therewith and the warranty provided herein shall automatically be terminated.

Governing Law; Saving Clause

This Warranty is part of the terms and conditions of the sale of the equipment covered hereunder and shall be governed by and enforced in accordance with the laws of the State of Ohio. Any provision hereof which is prohibited or unenforceable in any jurisdiction shall, as to such jurisdiction, be ineffective to the extent of such prohibition or unenforceability without invalidating the remaining provisions hereof or affecting the validity or enforceability of such provision in any other jurisdiction.

Limitation of Liability

IN NO EVENT SHALL AVTRON BE LIABLE IN CONTRACT, IN TORT OR OTHERWISE FOR SPECIAL, INCIDENTAL, CONSEQUENTIAL OR PUNITIVE DAMAGES (INCLUDING, BUT NOT LIMITED TO, LOSS OF PROFITS OR REVENUES, LOSS OF USE OF THE EQUIPMENT OR ANY DAMAGE TO ASSOCIATED EQUIPMENT, DAMAGE OR INJURY TO PERSONS OR PROPERTY, COST OF CAPITAL, COST OF SUBSTITUTE OR TEMPORARY EQUIPMENT, DOWNTIME OR CLAIMS OF CUSTOMERS) ARISING OUT OF OR AS A RESULT OF BREACH OF WARRANTY, DEFECT IN MATERIAL OR WORKMANSHIP OR ANY OTHER OBLIGATION OF AVTRON HEREUNDER.

Disclaimer of All Other Warranties

THIS WARRANTY COMPRISES AVTRON'S SOLE AND ENTIRE WARRANTY OBLIGATION TO BUYER, ITS CUSTOMERS AND ASSIGNS IN CONNECTION WITH EQUIPMENT SOLD, ASSIGNED, LEASED OR OTHERWISE DEALT WITH BY AVTRON. ALL OTHER WARRANTIES, EXPRESS OR IMPLIED, INCLUDING, BUT NOT LIMITED TO, WARRANTIES OF MERCHANTABILITY AND FITNESS, ARE EXPRESSLY EXCLUDED.

