

INSTRUCTION MANUAL

MODEL : K711B
300 KW, 480 V, 3 P, 60 H
PARTS # : 73127

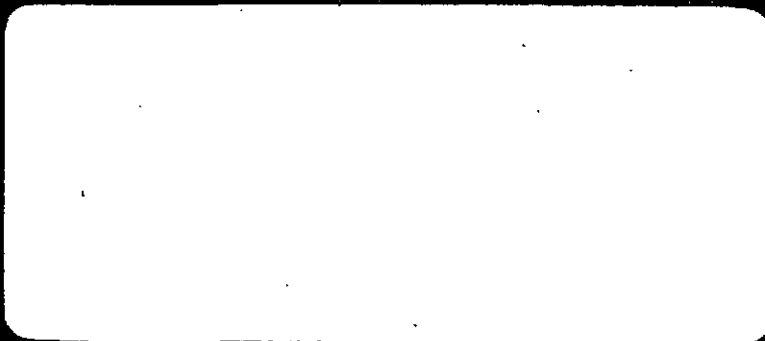

Specialists in the Following Services for Industry

DIGITAL MEASUREMENT AND CONTROL SYSTEMS
TEST EQUIPMENT FOR AIRCRAFT ELECTRICAL COMPONENTS
RESISTIVE AND REACTIVE LOAD BANKS
ROTARY PULSE GENERATORS
AUTOMATIC WINDING TEST SYSTEMS

 **AVTRON** MANUFACTURING, INC.

All Sales and Service for
Aircraft Test Equipment:
7900 E. Pleasant Valley Rd.
Independence, Ohio 44131-5529
TELEPHONE (216) 642-1230
FACSIMILE (216) 642-6037

Service for All
Other Products:
10409 Meech Ave.
Cleveland, Ohio 44105-4183
TELEPHONE (216) 641-8310
FACSIMILE (216) 341-8803

**AVTRON MODEL K711
LOAD BANK, RESISTIVE, DUCT MOUNT
Serial Number 825 and Above**

Project 250339

**AVTRON MODEL K711
LOAD BANK, RESISTIVE, DUCT MOUNT
Serial Number 825 and Above**

© 1996 Avtron Manufacturing, Inc.
Cleveland, Ohio

October 5, 1996
Rev. July 26, 1999

PROPRIETARY NOTE

This document contains information PROPRIETARY to Avtron Manufacturing, Inc., is furnished solely to provide information sufficient for instruction, operation, maintenance, evaluation, and testing of the equipment herein disclosed, is not to be used for manufacturing or procurement and is not to be disclosed to anyone other than persons in the Division, or the Company, or the Government, as the case may be, responsible for action relating to this document without the express written permission of Avtron Manufacturing, Inc.

WARRANTY

The last page of this document contains an express limited warranty. The provisions of this warranty cover any and all rights extended to holders of Avtron equipment.

Feb. 1995

WHEN ORDERING SERVICE OR
REPAIR PARTS, PLEASE SPECIFY
MODEL NO. AND/OR PART NO.
LOCATED ON NAMEPLATE AND
DWG. NO. A26623.

APPLICATION		REVISION				
MODEL/PART NO.	MODIFIED	ECN	LTR	DESCRIPTION	DATE	APPROVAL
K711B-68-68-480U-GH						

PARTS NOT REQUIRED

PART NO.	QTY	ASSEMBLY	DESCRIPTION	DISP	REF DESIG
B14796	6	TOP	RELAY	2	K1A-K1F
360589	4	TOP	TOGGLE SWITCH	2	S1,S2,S20-S21
B24778-1	4	TOP	MOUNTING EAR	2	
B24778-2	4	TOP	MOUNTING EAR	2	
502510	8	TOP	SCREW, 1/4-20 X 0.75	2	
C21390	1	TOP	OPTION PANEL	2	
D26306-4	1	TOP	COMPONENT MOUNTING PANEL	2	
D26307-4	1	TOP	CABINET MODIFICATION	2	
A97336	1	TOP	PLATE, IDENT	2	

NEW PARTS REQUIRED

PART NO.	QTY	ASSEMBLY	DESCRIPTION	DISP	REF DESIG
A24032	1	TOP	NAMEPLATE		

DISPOSITION

- 1) RETURN TO VENDOR
- 2) RETURN TO STOCK
- 3) SCRAP
- 4) RETURN TO SURPLUS

NEW DRAWINGS _____

PROJECT 250339

WIRING DIAGRAMS AFFECTED _____

SCHEMATICS AFFECTED C23327

THIS DOCUMENT CONTAINS PROPRIETARY INFORMATION OF AVTRON MFG., INC. AND MAY NOT BE DISCLOSED TO OTHERS OR USED FOR MANUFACTURING PURPOSES WITHOUT THE WRITTEN CONSENT OF AVTRON MFG.

DRAWN	KUK	DATE	3/28/00	 AVTRON MANUFACTURING, INC. INDEPENDENCE, OHIO	TITLE	MOD., BULK LOAD, TYPE B LESS ENCLOSURE AND DIST. BLOCK			PSF	
ENG MGR	D.KOZAR	DATE	3/28/00		CAGE NO.	SIZE	DRAWING NO.	SH	OF	REV
APP'D PROD	ZIMMERMAN	DATE	3/30/00		01014	A	A26623	1	3	

APPLICATION		REVISION			
MODEL/PART NO. MODIFIED	ECN	LTR	DESCRIPTION	DATE	APPROVAL
K711B-68-68-480U-GH					

PARTS NOT REQUIRED

PART NO.	QTY	ASSEMBLY	DESCRIPTION	DISP	REF DESIG
D23613	1	TOP	OVERLAY	2	
364103	1	TOP	TERMINAL BOARD	2	TB1
450028	1	TOP	INSULATION	2	XTB1
324128	1	TOP	FUSE	2	F1
325022	1	TOP	FUSEHOLDER	2	XF1
329714	1	TOP	LIGHT, INDICATOR (RED)	2	DS21
329715	1	TOP	LIGHT, INDICATOR (GREEN)	2	DS20
C23327	1	TOP	SCHEMATIC/WD (CONTROLS)	3	
364973	1	TOP	DISTRIBUTION BLOCK	2	PDB1

NEW PARTS REQUIRED

PART NO.	QTY	ASSEMBLY	DESCRIPTION	DISP	REF DESIG

DISPOSITION

- 1) RETURN TO VENDOR
- 2) RETURN TO STOCK
- 3) SCRAP
- 4) RETURN TO SURPLUS

NEW DRAWINGS _____

WIRING DIAGRAMS AFFECTED _____

SCHEMATICS AFFECTED _____

THIS DOCUMENT CONTAINS PROPRIETARY INFORMATION OF AVTRON MFG., INC. AND MAY NOT BE DISCLOSED TO OTHERS OR USED FOR MANUFACTURING PURPOSES WITHOUT THE WRITTEN CONSENT OF AVTRON MFG.

DRAWN KUK	DATE 3/28/00		TITLE MOD., BULK LOAD, TYPE B LESS ENCLOSURE AND DIST. BLOCK PSF		
ENG MGR D.KOZAR	3/28/00		CAGE NO. 01014	SIZE A	DRAWING NO. A26623
APP'D PROD ZIMMERMAN	3/30/00		SH 2	OF 3	REV

APPLICATION		REVISION				
MODEL/PART NO.	MODIFIED	ECN	LTR	DESCRIPTION	DATE	APPROVAL
K711B-68-68-480U-GH						

MODIFICATION REQUIRED

SCOPE: PROVIDE LOAD BANK FRAME AND RESISTORS (300KW BULK LOAD); MADE UP OF 6-50KW LOAD STEPS. NO CONTACTORS, FUSES, DISTRIBUTION BLOCK, OR CONTROL PANEL IS TO BE PROVIDED.

ASSEMBLY INSTRUCTIONS:

1. INSTALL RESISTOR ELEMENTS PER K711B ASSEMBLY PRINTS.
2. WIRE THE RESISTOR ELEMENTS PER C23068, FIGURE #2.

NOTE: THE CUSTOMER IS TO PROVIDE THE WIRING FROM THE RESISTOR ELEMENTS TO THE POWER DISTRIBUTION BLOCK. THE RECOMMENDED WIRE IS #6 AWG, 150 DEGREES C., UL TYPE 3321 OR EQUIVALENT. SEE THE SCHEMATIC BELOW.

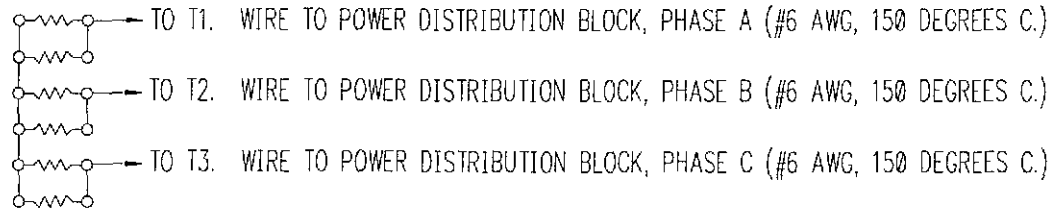

THIS DOCUMENT CONTAINS PROPRIETARY INFORMATION OF AVTRON MFG., INC. AND MAY NOT BE DISCLOSED TO OTHERS OR USED FOR MANUFACTURING PURPOSES WITHOUT THE WRITTEN CONSENT OF AVTRON MFG.

DRAWN	KUK	DATE	3/28/00
ENG MGR	D.KOZAR	DATE	3/28/00
APP'D PROD	ZIMMERMAN	DATE	3/30/00



TITLE MOD., BULK LOAD, TYPE B LESS ENCLOSURE AND DIST. BLOCK				PSF
CAGE NO.	SIZE	DRAWING NO.	SH	OF
01014	A	A26623	3	3
			REV	

AVTRON MODEL K711
LOAD BANK, RESISTIVE, DUCT MOUNT
 Part Number K711B-6B-6B-4B0U-GH
 MODIFIED PER A26623
 PROJECT NO. 250339

Load Bank Ratings:

Total KW 300 KW
 Operating Voltage (Volts, Phase, Frequency, Amps) 480 VAC,
3 Phase, 60 Hz., 360.8 Amps.
 Load Steps (KW) One 300 KW Bulk Load Step.
 Minimum airflow required for full load operation 27,744 CFM

TABLE OF CONTENTS

<u>Section</u>		<u>Page</u>
I	SAFETY CONSIDERATIONS	1-1
II	DESCRIPTION AND SPECIFICATIONS	2-1
III	INSTALLATION	3-1
IV	OPERATION	4-1

DRAWINGS

S82588 Outline Drawing
C23327 Schematic/Wiring Diagram (Controls)
C23068 Schematic/Wiring Diagram, Load Bank

BULLETINS

202 Installation Notes, Engine Generator,
 Duct or Radiator Type

 203 Sample Calculations, Engine Generator,
 Duct Type Load Banks

DERIVATION OF K711/K711A LOAD BANK PART NUMBER AND CALCULATIONS FOR AMPS and AIRFLOW REQUIREMENTS

The K711/K711A part number identifies the size, electrical characteristics, and the options which apply to a given unit. An explanation of how K711/K711A part numbers are configured and how to decipher them follows:

K711/K711A part numbers take the form K711(A)-YY-XX-VVVU(F)-C-O where:

YY = HEIGHT IN INCHES
 XX = WIDTH IN INCHES
 VVV = VOLTAGE (208, 240, 480 OR 600V)
 U, F = UNFUSED OR FUSED LOAD STEPS
 C = LOAD STEPS (Quantity of load step precedes identifier if more than 1.)
 O = OPTION NUMBERS (may be stacked)

LOAD STEP IDENTIFIER

A = 5 KW
 B = 10 KW
 C = 15 KW
 D = 20 KW
 E = 25 KW
 F = 50 KW
 G = 100 KW
 H = 200 KW
 J = 400 KW

OPTION IDENTIFIER

A = 19" REMOTE CONTROL PANEL
 B = NEMA 12 ENCLOSURE FOR REMOTE CONTROL PANEL
 C = SINGLE STEP LOAD SHEDDER
 D = TWO STEP LOAD SHEDDER
 E = THREE STEP LOAD SHEDDER
 F = FOUR STEP LOAD SHEDDER
 G = OUTDOOR OPTION (W/LOUVERS)
 H = 208:120 CONTROL TRANSFORMER
 J = 240:120 CONTROL TRANSFORMER
 K = 480:120 CONTROL TRANSFORMER
 L = 600:120 CONTROL TRANSFORMER
 M = FLEXIBLE FLANGE ADAPTER DUCT (MALE)
 N = FLEXIBLE FLANGE ADAPTER DUCT (FEMALE)
 O = FLANGE ADAPTER

EXAMPLE: K711-40-36-208U-3FG-C,G

DESCRIPTION - CORE SIZE 40" H x 36" W RATED 208 V, 3-PH.
 UNFUSED LOAD STEPS OF THREE @ 50 KW AND
 ONE AT 100 KW WITH OPTIONAL SINGLE STEP
 LOAD SHEDDER AND LOUVERS

To calculate the minimum airflow requirement:

MINIMUM CFM REQ'D =

CORE DIMENSIONS (W" x H") x 6

To calculate Amperage: $\text{Amps} = \frac{\text{KW} \times 577}{\text{L-L Volts}}$

AVTRON MODEL K711
LOAD BANK, RESISTIVE, DUCT MOUNT
Serial Number 825 and Above

SECTION I

SAFETY CONSIDERATIONS

Throughout this manual, you will find **WARNING** and **CAUTION** statements. Personal injury to an operator using or repairing the equipment may occur if a **WARNING** statement is ignored. Damage to the equipment and potentially hazardous conditions for personnel may occur if a **CAUTION** statement is ignored.

Each Avtron unit is safety checked for opens and shorts, and the insulation is high potential tested to insure safe operation. All fuses, safety interlocks, and related safety equipment have been proven reliable as part of the testing procedure of each unit.

As part of your safety program, an initial inspection after receiving the unit(s) and periodic preventive maintenance and safety inspections should be conducted to insure the reliability and safety built into your Avtron equipment.

The Model K711 Load Bank is an industrial test unit designed to be used indoors safely. However, because of the nature of the Load Bank function (the dissipation of electrical energy), there are inherent dangers to operators and equipment. These dangers are outlined in this section.

Electrical energy is transformed into heat by the resistors. This heat must be removed from the Load Bank by the cooling blower. If there is any restriction or stoppage of airflow, the Load Bank may overheat and may even start a fire. It is recommended that:

1. The operator should read the manual before using the Load Bank.
2. Run an approved ground wire from the Load Bank ground lug, located inside the load connection area to the generator frame. Run an approved ground wire from the generator frame to a good earth ground.

Safety Considerations

3. If your unit is equipped with an airflow safety or temperature switch, do not bypass the airflow safety or temperature switch to prevent nuisance tripping. The switches drop out load if insufficient air is reaching the load elements.
4. When installing the Load Bank, do not drill into side flanges. Use only top and bottom flanges as mounting locations. Compliance with this instruction helps guard against damage to internal wiring.
5. If the unit is to be installed within existing duct work, leave enough access area to easily remove access covers on each side of the Load Bank. Special consideration should be given to mounting surface material due to hot air exhaust.
6. Maintenance personnel must always exercise caution when the access panels are removed. Personal injury from electrical shock may result if all sources of power are not disconnected before servicing. Maintenance work must be done only by qualified personnel.
7. Adequate airflow in cubic ft./min. (CFM) must be maintained at all times. (Refer to the DESCRIPTION section for minimum value of required airflow.) Failure to maintain this airflow evenly across the resistor elements may result in element burnout.
8. If duct work is vented through a screened exhaust or louvered exhaust, insure that the louvers (if motorized) are fully open when using the Load Bank. If exhausting through a screened opening, check screen periodically for any blockage.
9. After running a load test, residual heat may be removed from the Load Bank and downstream duct work by allowing the blower to operate for a few minutes after loads are removed. This procedure is not required for Load Bank integrity, but it may guard operating personnel from possible burn injuries.
10. The operator should avoid coming in contact with the resistor elements or surrounding covers during and for some time after operation. These portions of the Load Bank become quite hot and may result in a serious burn should contact be made with them.
11. Operators must not operate the Load Bank with the access panels or screens removed. To do so would expose the operator and other persons to possible personal injury from electrical shock.
12. An approved electrical fire extinguisher should be on hand at all times.

Safety Considerations

13. It is the responsibility of the customer to take diligent care in installing the Load Bank. The National Electrical Code (NEC), sound local electrical and safety codes, and the Occupational Safety and Health Act (OSHA) should be followed when installing the equipment to reduce hazards to persons and property.
14. Read and heed all **WARNING** and **CAUTION** statements in the manual.

SECTION II

DESCRIPTION AND SPECIFICATIONS

The Avtron Model K711 is designed to be used as a duct- or radiator-mounted Load Bank providing custom tailored mounting and installation. The K711 provides a resistive load rated as indicated on the Table of Contents. Minimum airflow required to cool the elements operating at full load is as indicated on the Table of Contents and must be maintained to insure safe operation of the Load Bank.

C A U T I O N

To prevent load element burnout, adequate airflow must be maintained over the entire load element area at all times voltage is applied. Insufficient air for even a few seconds will cause element burnout. This unit must have uniform airflow over the entire outlet area. If there are dead spots, damage to the elements may result.

CONTROL PANEL

The K711 Load Bank may be provided with a Control Panel as an option or the Control Panel may be customer supplied. The Control Panel may be supplied by Avtron in one of the following ways:

1. Factory installed on the side of the Load Bank without an enclosure.
2. Factory installed on the side of the Load Bank within an enclosure.
3. Factory installed within a remote mountable enclosure, separate from the Load Bank.

Description and Specifications

4. Factory supplied without an enclosure for remote mounting.

The Control Panel, when provided, serves as the manual control center for Load Bank operation. All load switches, safety indicator lights, and control circuit fuses are mounted on the panel.

When the Control Panel is not factory supplied, load application and safety circuitry are the responsibility of the customer.

Each K711 is designed with a relay compartment which contains load contactors, safety circuit components, optional load step fusing, optional control transformer with fuses, and a customer connection bus. If a Control Panel is not factory installed, the components in the relay compartment will require interconnection wiring during field installation of the Load Bank.

Interconnection wiring should conform to the National Electrical Code and any local codes.

AUTO TRANSFER SWITCH CAPABILITY

The load control circuitry is factory designed in such a way that remote operation with a customer-supplied transfer switch may be incorporated into the circuit. The factory control circuitry will be wired to a terminal board whereas a transfer switch must be enabled and connects at the terminal board per the schematic.

AUTOMATIC OPERATION

An Automatic Load Shed Controller (Controller) may be integrated into the control circuitry of the K711 Load Bank as an option. The Controller is designed to maintain a minimum load on a power source. A separately supplied current transformer provides the feedback signal required to operate the Controller. This feedback signal drives the Controller, which has field adjustable current setpoints. The Controller also incorporates field adjustable time delays to prevent repetitive load switching or initial overloading of the generator.

The Load Bank manual controls are paralleled by the automatic Controller. Automatic or manual mode may be chosen when the Load Shed option is provided with the Load Bank.

Description and Specifications

LOUVERS (OPTIONAL)

The exhaust of the Load Bank may be protected by either a stationary or motorized louver assembly.

The motorized version includes a limit switch which prevents the application of load steps if the louvers are not fully open.



ESD PRECAUTIONARY GUIDELINES



C A U T I O N

Certain circuit card assemblies and their components, typically integrated circuits, may be damaged by seemingly undetectable electrostatic discharge (ESD). Care must be exercised during handling/repair of these items. Use electrostatic discharge precautionary procedures.

The following guidelines are not necessarily all inclusive but rather serve as reminders for good shop practices for the handling/repair of ESD sensitive circuit card assemblies and devices.

- Store ESD sensitive items in their original containers. These items are often marked with this symbol .
- Put on a grounded wrist strap before handling any ESD sensitive item.
- Clear work area of Styrofoam^{R*}, plastic, and vinyl items such as coffee cups.
- Handle ESD items by the body, never the open edge connectors.
- Never slide ESD sensitive items over any surface.
- Transport ESD sensitive items in a static shielding container to a static-free work station.
- If a static-free work station is not available, ground the transport container before removing or inserting an ESD item.
- Electric tools used during repair should be grounded. For example, use only anti-static type solder suckers and grounded tip soldering irons. Discharge non-electric tools before use.
- Pack ESD items in static shielding containers before shipping them to Avtron for repair.

*Styrofoam^R is a registered trademark of Dow Chemical.

SECTION III

INSTALLATION

This Load Bank is designed for direct installation in a ventilation duct or on the exhaust end of a radiator. Use standard 1/4 inch hardware to mount the Load Bank to the duct or radiator. Do not extend the hardware into the Load Bank more than a maximum of 1/2 inch to insure adequate clearance between element terminations and mounting hardware. Bulletin 202 shows the proper positioning of the Load Bank in the air duct.

C A U T I O N

To prevent load element burnout, adequate airflow must be maintained over the entire load element area at all times voltage is applied. Insufficient air for even a few seconds will cause element burnout. This unit must have uniform airflow over the entire outlet area. If there are dead spots, damage to the elements may result.

In general, the protection provided external to the Load Bank is determined by the local codes. Since the Load Bank is generally part of an existing electrical installation, it must be protected by a fused disconnect or circuit breaker meeting all local codes.

Before making any electrical connections, the maximum phase current for the Load Bank should be determined. This may be done using the following formula.

$$I_{\text{PHASE}}^{\text{(MAX)}} = \frac{\text{KW} \times 577}{V \text{ (Line-to-Line)}}$$

Installation

C A U T I O N

When installing the Load Bank, do not drill into side flanges. Use only top and bottom flanges as mounting locations. Compliance with this instruction helps guard against damage to internal wiring.

The electrical connections necessary for proper operation of the Load Bank are as follows:

1. Connect the load power source as indicated on the Schematic/ Interconnection Diagram.
2. A ground connection must be made to the Load Bank (GND terminal) to prevent injury to personnel. This may be accomplished by a ground wire connected directly to the Load Bank ground stud provided in the control box. This ground wire should be connected to the frame of the generator under test. The generator frame should be grounded to a good earth ground.
3. Make control circuit connections as required using #14 AWG wire minimum. Refer to the Schematic Diagram found at the end of this manual for the required control voltage. For conduit runs greater than 50 feet, consult the factory.
4. When an automatic Controller is included with the Load Bank, installation of the current transformer on the main power bus as shown in Figure 3-1 is required. Wire the current transformer into the control circuitry as shown on the provided schematic.

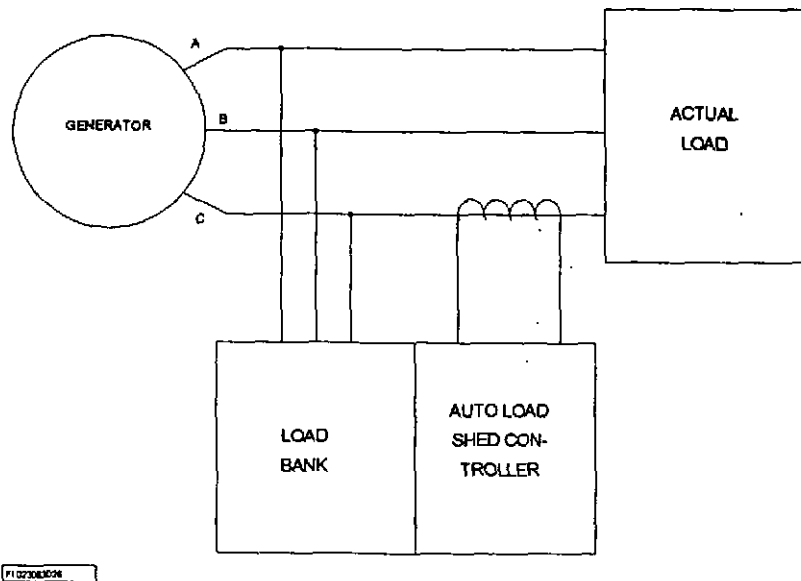

Figure 3-1

W A R N I N G

Always put a short or shunt across the current transformer when servicing the Load Bank. Primary current flowing through an unshunted current transformer will destroy the transformer with possible harm to personnel.

Never allow the secondary of the current transformer to remain disconnected when primary current is passing through the transformer. If the Load Bank must be disconnected, put a short or shunt across the current transformer.

NOTE

Before placing the system into AUTO, place the Load Bank load step switch(es) to the OFF position.

OPTIONAL CONTROLLER OPERATION AND ADJUSTMENTS

W A R N I N G

Always put a short or shunt across the current transformer when servicing the Automatic Load Shed Controller. Primary current flowing through an unshunted current transformer will destroy the transformer with possible harm to personnel.

Before the current setpoint(s) can be adjusted, the operator must determine the maximum load the Controller should maintain (generally 60% to 80% of the total generator KVA).

SETPOINT CALCULATION (Example)

1. Generator Rating = 15 KVA at 240 VAC, 62.5 Amps
2. Setpoint Value (approximately 60% of Full Load)

$$\begin{aligned} \text{Setpoint} &= 15 \times 0.6 = 9 \text{ KW} \\ 9 \text{ KW at } 240 \text{ V} &= 37.5 \text{ Amps} \end{aligned}$$

TRIP POINT ADJUSTMENTS

There are three methods of field adjusting the trip point of the current sensing relays:

- Method 1 - Using generator load power
- Method 2 - Using a separate (0-5 Amp) current source without the current transformer
- Method 3 - Rough adjustment (Approximation Method)

Installation

METHOD 1 - Using the Actual Generator Load Power

This method uses the load current to set the current setpoint(s).

1. Apply 120 VAC, 60 Hz control power. (See schematic.) Place AUTO/MANUAL switch to MANUAL.

W A R N I N G

There is lethal high voltage present within the Controller enclosure; care must be taken when proceeding from this point.

2. On the Controller, turn the adjustable potentiometer, labeled LEVEL PERCENT, down to its lowest setting.
3. Energize the system while on line. Refer to the OPERATION instructions in Section IV.

NOTE

Always monitor the generator load with external metering so as not to overload the generator.

4. Adjust the generator load until the load equals the desired setpoint. The Load Bank can be used manually to achieve the desired load current if the current transformer is relocated to sense both building load and Load Bank load. Otherwise use actual building load.

NOTE

On the Controller, there is an LED indicator for each channel (Output). When lit, the channel is energized.

Channel 1 (LED CR13)
Channel 2 (LED CR17)
Channel 3 (LED CR21)
Channel 4 (LED CR25)
Channel 5 (LED CR29)

Installation

Turn the adjustable potentiometer, labeled LEVEL PERCENT, past the trip point (completely counterclockwise; LED is off). Then turn slowly clockwise until the channel trips on (LED is on).

METHOD 2 - Using a separate (0-5 Amp) Current Source without Current Transformer

1. Disconnect all sources of power to the Automatic Load Shed Controller.

W A R N I N G

When disconnecting the current transformer, the secondary terminals must be shorted. The secondary of an unshorted current transformer can exceed several thousand volts.

2. Apply 120 VAC, 60 Hz control power. (See schematic.)

W A R N I N G

There is lethal high voltage within the control enclosure.

3. Using a controlled current source, apply the setpoint current (from secondary current calculation) to Controller terminals J1-1 and J1-2.
4. Turn the adjustable potentiometer, labeled LEVEL PERCENT, counterclockwise past the trip point; then decrease until the channel trips on, indicated by LED turning on.

Installation

METHOD 3 - Rough Adjustment

Use the following formula to calculate the percentage C.T. Tap chosen to operate the P.C. Board:

$$\% \text{ Dial Setting} = \text{Setpoint}/\text{C.T. Tap}$$

**INSTALLATION CHECKOUT PROCEDURE -
TO BE DONE PRIOR TO OPERATION**

This Installation Checkout Procedure is intended to be used upon initial receipt of equipment and following any relocation of a permanent mounted Load Bank. These procedures apply to Load Banks in general and may include steps not relevant to the specific unit being installed. Disregard those procedures which do not apply.

W A R N I N G

THE FOLLOWING TESTS ARE TO BE ACCOMPLISHED BY A QUALIFIED ELECTRICIAN OR TECHNICIAN USING EXTREME CAUTION AS POTENTIALLY LETHAL VOLTAGES AND DANGEROUS ROTATING COMPONENTS ARE PRESENT. IF ASSISTANCE IS REQUIRED, AVTRON CAN PROVIDE START UP SERVICE AT A NOMINAL CHARGE. AVTRON ALSO WILL PROVIDE TELEPHONE ASSISTANCE IF REQUIRED BY CALLING (216) 641-8310.

1. Verify the Load Bank placement meets the installation requirements found in the Installation section of the instruction manual:
 - A. Check the clearance from both intake and exhaust to any obstruction.
 - B. If the location has a prevailing wind, make the wind aid in the cooling of the resistor elements.
 - C. If the Load Bank is elevated, a plate under the Load Bank will be needed to block hot exhaust from returning to the intake.

Installation

2. Check the mechanical integrity of all customer-supplied interconnection wiring:
 - A. Check lugs that they are properly crimped.
 - B. Check terminations that they are properly torqued.
3. Utilize system schematics to ohm out customer-supplied interconnection control wiring and safety circuits:
 - A. If control wiring is all the same color, ohm out each individual wire to confirm proper labeling and placement.

C A U T I O N

Control wiring must be a minimum of 14 AWG for wire runs under 50 feet. Consult Avtron factory for wire sizing when wire run exceeds 50 feet.

- B. Confirm the correct wire gauge has been used for interconnection wiring. Control wiring should be a minimum of 14 AWG for control panel to Load Bank lengths of 50 feet or less. For lengths greater than 50 feet, consult the factory.
- C. If a Control Transformer is the source of control power, disconnect the control transformer before proceeding.

C A U T I O N

When control power is supplied by a transformer within the Load Bank, it must be disconnected before running this installation checkout procedure. Failure to disconnect the control transformer may damage the Load Bank.

4. Energize the source of control power only. Check the control voltage and confirm it is within 10% of the required voltage.

W A R N I N G

Control power is present on terminal block in steps 4 through 6.

5. Verify the proper relays energize with each individual load switch.
 - A. Turn on each load step individually and observe that each relay or relays pulls in without chatter or hesitation.
 - B. Turn off the master load switch. Turn on all the load steps. Turn the master load on and observe the pull in of all the contactors. If chatter or hesitation is observed, locate the cause of the voltage drop causing the problem.
6. Apply the rated fan voltage. Start blower and verify that air is exiting the resistor assembly end.

This checkout procedure is intended to be a guide to Load Bank installations in general. Special installation considerations not addressed herein may be necessary due to installation site or environment. Any questions or concerns regarding Load Bank installation should be directed to Avtron Field Service at (216) 641-8310.

SECTION IV

OPERATION

C A U T I O N

DO NOT operate the Load Bank over the rated voltage as this will cause a catastrophic failure in the Load Bank.

DO NOT apply DC voltages to the Load Bank because the contactors do not have arc blowout magnets.

To prevent load element burnout, adequate airflow must be maintained over entire load element area at all times voltage is applied. Insufficient air for even a few seconds will cause element burnout.

It is important to note that if the generator is removed, the control circuit may still be energized if control power is not removed. Therefore, before removing cover, make certain all sources of power to the Load Bank are disconnected.

The K711 Load Bank may be operated in a manual mode or, if the Load Shedder option is provided, in an automatic mode. Operation instructions for the different modes are as follows:

1. Manual Operation - K711 units without a Control Panel.
2. Manual Operation - K711 units with a Control Panel included as an option.
3. Automatic Operation - K711 units with the Load Shedder option.

Operation

Take note that in cases where the K711 Load Bank is provided with the transfer switch option, to permit load application, the terminal board terminals referenced on the schematic for this application must be connected either by a hard wired jumper or a closed transfer switch contact.

MANUAL OPERATION (for K711 units without a Control Panel)

After mounting the K711, connecting 120 V control power, and running interconnecting control wires per the schematic:

1. Check to confirm that all load contactors will not be energized prematurely.
2. Connect generator or other source to be tested to the Load Bank as described in the INSTALLATION section.
3. Apply power to the control circuit. (If Load Bank has motorized louvers, verify louvers are open prior to the initiation of airflow.)
4. Start power source under test. Be sure air is flowing over resistance elements.
5. Apply load to the power source by energizing load contactors.
6. Shutdown - After running a load test, residual heat may be removed from the Load Bank and downstream duct work by allowing the blower to operate for a few minutes after loads are removed. This procedure is not required for Load Bank integrity, but it may guard operating personnel from possible burn injuries.

MANUAL OPERATION (for K711 units with a Control Panel included as an option)

After mounting the K711, connecting 120 V control power, and running interconnecting control wires per the schematic:

1. Place all switches on the Control Panel to the OFF position.
2. Place AUTO/MANUAL switch to MANUAL. (This step only applies to Load Banks with Load Shedder option.)
3. Connect the generator or other power source to be tested to the Load Bank as described in the INSTALLATION section.

Operation

4. Place the POWER switch to the ON position. The POWER light will be energized indicating control power is present. (If Load Bank has motorized louvers, verify louvers are open prior to the initiation of airflow.)
5. With the MASTER LOAD switch in the OFF position, start the generator under test. Using a customer-supplied blower, be sure air is flowing over the resistance elements.
6. The resistive loading is selected by load step switches, using any one or a combination to make up a given load.
7. Apply load to the power source by moving the MASTER LOAD switch to the ON position.
8. Any load can be added or removed during MANUAL testing provided the MASTER LOAD switch is on.
9. To remove all loads, move MASTER LOAD switch to the OFF position.
10. Shutdown - Place all switches in the OFF position. After running a load test, residual heat may be removed from the Load Bank and downstream duct work by allowing the blower to operate for a few minutes after loads are removed. This procedure is not required for Load Bank integrity, but it may guard operating personnel from possible burn injuries.

AUTOMATIC OPERATION (for K711 Load Banks with Load Shedder option)

After mounting the K711 and connecting 120 V control power per the schematic:

1. Place all switches on the Control Panel to the OFF position.
2. Connect the generator or other power source to be tested to the Load Bank as described in the INSTALLATION section.
3. Place the POWER switch to the ON position. The POWER light (DS1) will be energized, indicating control power is present. (If Load Bank has motorized louvers, verify louvers are open prior to the initiation of airflow.)
4. Place AUTO/MANUAL switch to AUTO.
5. Start the generator under test. Using a customer-supplied blower, be sure air is flowing over the resistance elements.

Operation

6. When the Auto Transfer Contact is open, the Auto Load Shedder will be active. As the load on the generator lessens, the Load Shed Controller will automatically apply load steps until the overall generator load exceeds the minimum setpoint. The Load Shed Controller automatically removes load steps when the generator load exceeds the maximum setpoint.

DRAWINGS

PROPRIETARY NOTE

The wiring diagrams and schematics which follow contain information PROPRIETARY to Avtron Manufacturing, Inc., are furnished solely to provide information sufficient for instruction, operation, maintenance, evaluation, and testing of the equipment herein disclosed, are not to be used for manufacturing or procurement and are not to be disclosed to anyone other than persons in the Division, or the Company, or the Government, as the case may be, responsible for action relating to this document without the express written permission of Avtron Manufacturing, Inc.

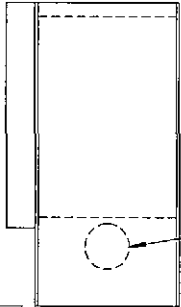
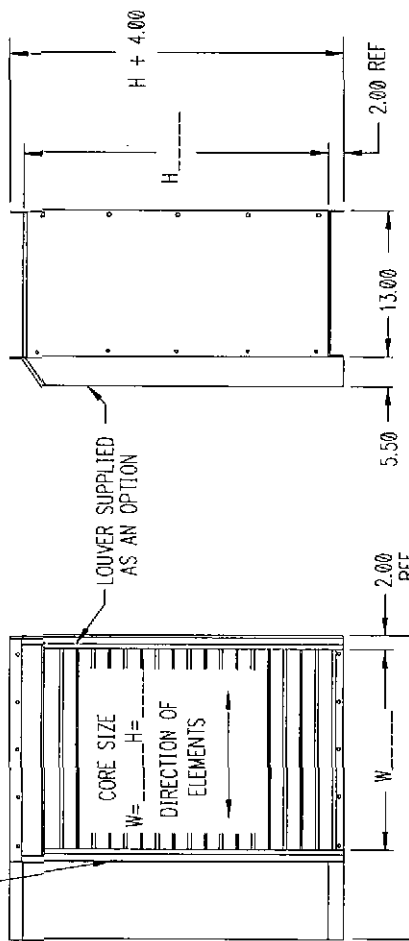
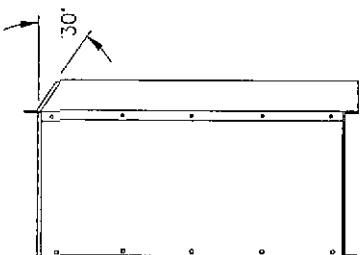

CONDUIT ENTRANCE FOR INTERCONNECTION TO REMOTE CABINET SECTION TO BE DRILLED BY CUSTOMER

CUSTOMER CONNECTION TERMINALS DIRECTLY TO LOAD ELEMENTS FOR INTERCONNECTION TO LOAD STEP CONTACTORS IN REMOTE CABINET

CORE SIZE
W = _____ H = _____
DIRECTION OF ELEMENTS

FOR APPLICATION ENGINEERING USAGE ONLY

DRAWN	DATE	DRAWING NUMBER
Demmin	3/15/96	SB2588
CHECKED		
APPROVED	BOHRER	LOAD BANK K711B LOAD ELEMENT SECTION
SCALE	NONE	SHEET 1 OF 2 OUTLINE DRAWING

ECN NO.	REV	CHG'D	CHK'D
		CHANGE	

2. ALL DIMENSIONS ARE APPROX.
1. WEIGHT: VARIES BETWEEN 100 & 500 LBS

NOTES:

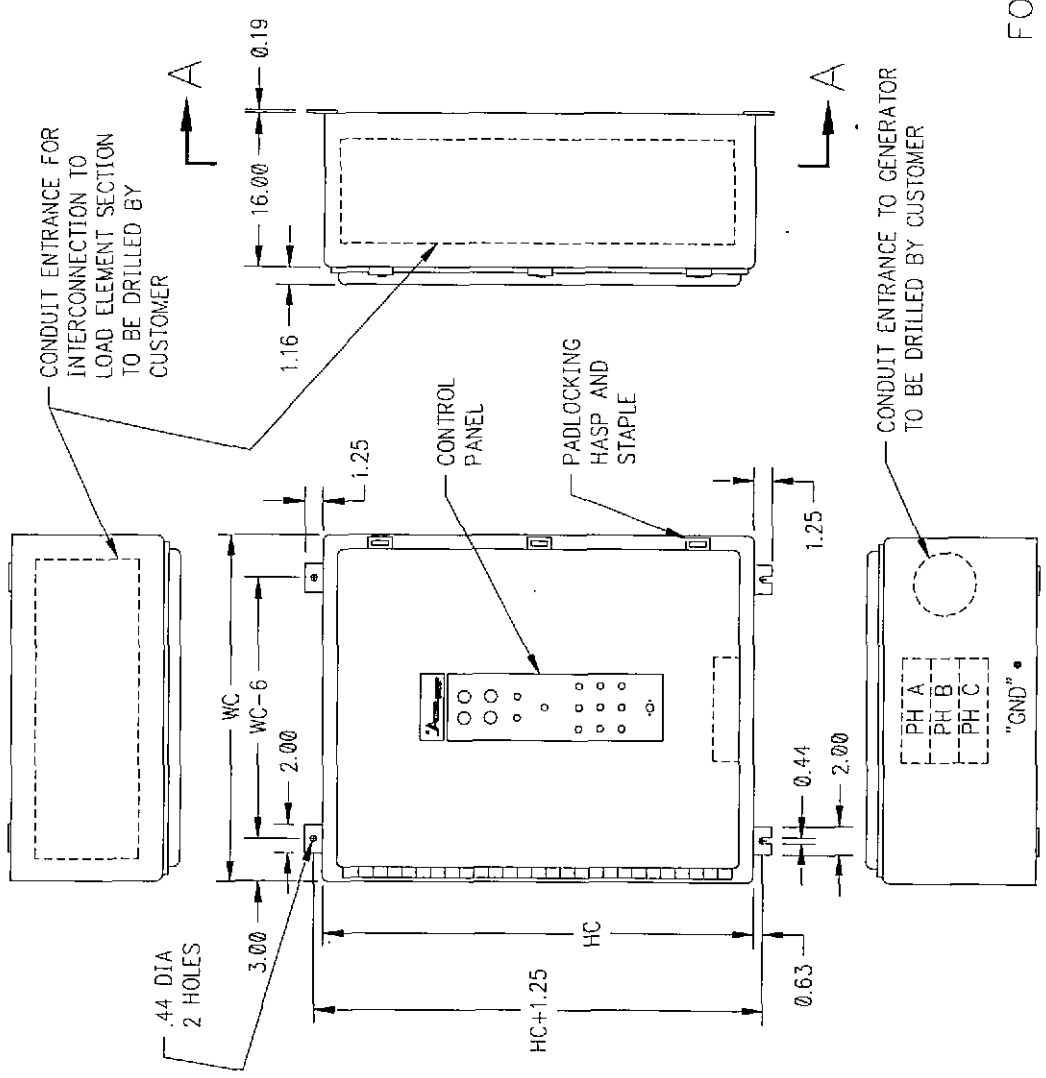

TYPICAL CONTACTOR AND FUSE SECTION CUSTOMER TO CONNECT TO CONTACTORS WITH INTERCONNECTION TO LOAD ELEMENTS IN LOAD ELEMENT SECTION

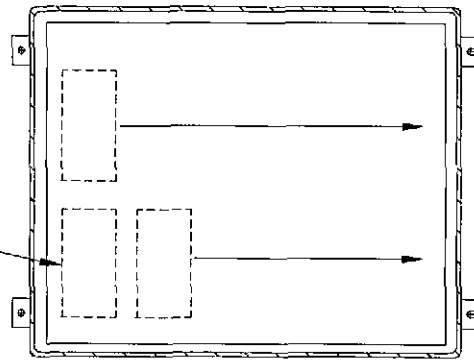

SECTION A — A

LOAD BANK CORE HEIGHT	HC	WC
20 THRU 34	30.00	24.00
36 THRU 64	30.00	36.00
66 THRU 90	46.00	36.00

FOR APPLICATION ENGINEERING USAGE ONLY

DRAWN Demin 3/15/96		DATE 3/15/96		DRAWING NUMBER SB2588	
CHECKED		SCALE NONE		LOAD BANK K711B	
APPROVED		BOHRER		REMOTE CABINET SECTION	
ECON. REV. NO. 1. ET.		CHANGE		SHEET 2 OF 2	
CH'D		CH'D		OUTLINE DRAWING	

- NOTES:
- 3 - NEMA 12 ENCLOSURE, SINGLE DOOR, WALL MOUNTED.
 - 2 - ALL DIMENSIONS ARE APPROX.
 - 1 - WEIGHT: VARIES BETWEEN 100 & 500 LBS

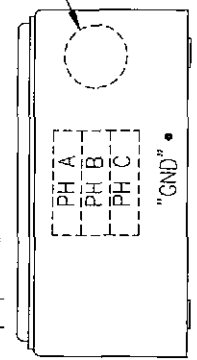

REVISIONS				
CON NO	REV	DESCRIPTION	DATE	APPROVED
001	A	ITEM 6 DESIGN ADDED "15K" C. ITEM 10 P/N 390122 WAS 390111, 390735 WAS 390814, P/N 390123 WAS 390122 THIS 390819, AND 390823 WAS 390824.	4/1/59	K.K.K.

LOAD STEP CONFIGURATION GUIDE

EXAMPLE PART NO. K711-26-30-480K-AZBC-AB

THIS DEFINES THE LOAD STEP CONFIGURATION AS
 A = 1 LOAD STEP OF 5KW
 B = 2 LOAD STEPS OF 10KW
 C = 1 LOAD STEP OF 15KW
 PER KEY BELOW

APPLY THE ABOVE EXAMPLE TO ACTUAL PART NO. OF ANY MODEL K711 LOAD BANK. REFER TO MATERIAL TABULATION AND THE APPLICABLE LOAD STEP DIAGRAM FIGURE.

LETTER	LOAD STEPS
A	5KW
B	10KW
C	15KW
D	20KW
E	25KW
F	50KW
G	100KW
H	200KW
J	400KW

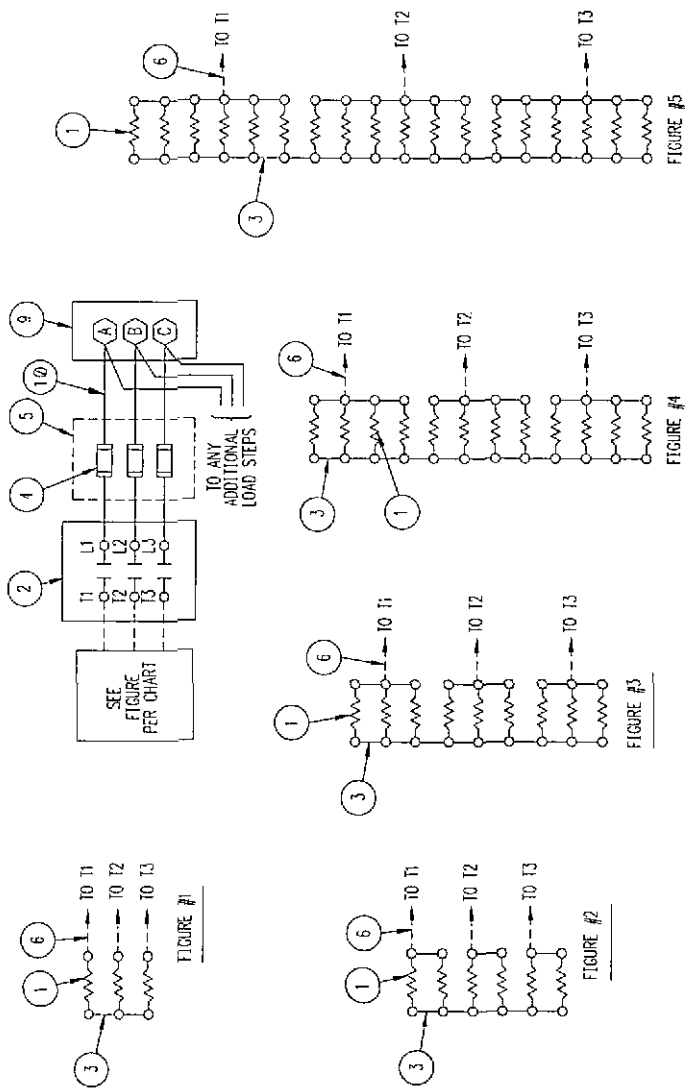

THIS IS REFERENCE INFORMATION, PARTS AND TOTAL QUANTITIES ARE SPECIFIED ON THE MFG TOP ASSEMBLY DRAWING.

AR	390323	AR	390322	AR	390321	AR	390320	AR	390319	AR	390318	AR	390317	AR	390316	AR	390315	AR	390314	AR	390313	AR	390312	AR	390311	AR	390310	AR	390309	AR	390308	AR	390307	AR	390306	AR	390305	AR	390304	AR	390303	AR	390302	AR	390301	AR	390299	AR	390298	AR	390297	AR	390296	AR	390295	AR	390294	AR	390293	AR	390292	AR	390291	AR	390290	AR	390289	AR	390288	AR	390287	AR	390286	AR	390285	AR	390284	AR	390283	AR	390282	AR	390281	AR	390280	AR	390279	AR	390278	AR	390277	AR	390276	AR	390275	AR	390274	AR	390273	AR	390272	AR	390271	AR	390270	AR	390269	AR	390268	AR	390267	AR	390266	AR	390265	AR	390264	AR	390263	AR	390262	AR	390261	AR	390260	AR	390259	AR	390258	AR	390257	AR	390256	AR	390255	AR	390254	AR	390253	AR	390252	AR	390251	AR	390250	AR	390249	AR	390248	AR	390247	AR	390246	AR	390245	AR	390244	AR	390243	AR	390242	AR	390241	AR	390240	AR	390239	AR	390238	AR	390237	AR	390236	AR	390235	AR	390234	AR	390233	AR	390232	AR	390231	AR	390230	AR	390229	AR	390228	AR	390227	AR	390226	AR	390225	AR	390224	AR	390223	AR	390222	AR	390221	AR	390220	AR	390219	AR	390218	AR	390217	AR	390216	AR	390215	AR	390214	AR	390213	AR	390212	AR	390211	AR	390210	AR	390209	AR	390208	AR	390207	AR	390206	AR	390205	AR	390204	AR	390203	AR	390202	AR	390201	AR	390200	AR	390199	AR	390198	AR	390197	AR	390196	AR	390195	AR	390194	AR	390193	AR	390192	AR	390191	AR	390190	AR	390189	AR	390188	AR	390187	AR	390186	AR	390185	AR	390184	AR	390183	AR	390182	AR	390181	AR	390180	AR	390179	AR	390178	AR	390177	AR	390176	AR	390175	AR	390174	AR	390173	AR	390172	AR	390171	AR	390170	AR	390169	AR	390168	AR	390167	AR	390166	AR	390165	AR	390164	AR	390163	AR	390162	AR	390161	AR	390160	AR	390159	AR	390158	AR	390157	AR	390156	AR	390155	AR	390154	AR	390153	AR	390152	AR	390151	AR	390150	AR	390149	AR	390148	AR	390147	AR	390146	AR	390145	AR	390144	AR	390143	AR	390142	AR	390141	AR	390140	AR	390139	AR	390138	AR	390137	AR	390136	AR	390135	AR	390134	AR	390133	AR	390132	AR	390131	AR	390130	AR	390129	AR	390128	AR	390127	AR	390126	AR	390125	AR	390124	AR	390123	AR	390122	AR	390121	AR	390120	AR	390119	AR	390118	AR	390117	AR	390116	AR	390115	AR	390114	AR	390113	AR	390112	AR	390111	AR	390110	AR	390109	AR	390108	AR	390107	AR	390106	AR	390105	AR	390104	AR	390103	AR	390102	AR	390101	AR	390100	AR	390099	AR	390098	AR	390097	AR	390096	AR	390095	AR	390094	AR	390093	AR	390092	AR	390091	AR	390090	AR	390089	AR	390088	AR	390087	AR	390086	AR	390085	AR	390084	AR	390083	AR	390082	AR	390081	AR	390080	AR	390079	AR	390078	AR	390077	AR	390076	AR	390075	AR	390074	AR	390073	AR	390072	AR	390071	AR	390070	AR	390069	AR	390068	AR	390067	AR	390066	AR	390065	AR	390064	AR	390063	AR	390062	AR	390061	AR	390060	AR	390059	AR	390058	AR	390057	AR	390056	AR	390055	AR	390054	AR	390053	AR	390052	AR	390051	AR	390050	AR	390049	AR	390048	AR	390047	AR	390046	AR	390045	AR	390044	AR	390043	AR	390042	AR	390041	AR	390040	AR	390039	AR	390038	AR	390037	AR	390036	AR	390035	AR	390034	AR	390033	AR	390032	AR	390031	AR	390030	AR	390029	AR	390028	AR	390027	AR	390026	AR	390025	AR	390024	AR	390023	AR	390022	AR	390021	AR	390020	AR	390019	AR	390018	AR	390017	AR	390016	AR	390015	AR	390014	AR	390013	AR	390012	AR	390011	AR	390010	AR	390009	AR	390008	AR	390007	AR	390006	AR	390005	AR	390004	AR	390003	AR	390002	AR	390001	AR	390000	AR	389999	AR	389998	AR	389997	AR	389996	AR	389995	AR	389994	AR	389993	AR	389992	AR	389991	AR	389990	AR	389989	AR	389988	AR	389987	AR	389986	AR	389985	AR	389984	AR	389983	AR	389982	AR	389981	AR	389980	AR	389979	AR	389978	AR	389977	AR	389976	AR	389975	AR	389974	AR	389973	AR	389972	AR	389971	AR	389970	AR	389969	AR	389968	AR	389967	AR	389966	AR	389965	AR	389964	AR	389963	AR	389962	AR	389961	AR	389960	AR	389959	AR	389958	AR	389957	AR	389956	AR	389955	AR	389954	AR	389953	AR	389952	AR	389951	AR	389950	AR	389949	AR	389948	AR	389947	AR	389946	AR	389945	AR	389944	AR	389943	AR	389942	AR	389941	AR	389940	AR	389939	AR	389938	AR	389937	AR	389936	AR	389935	AR	389934	AR	389933	AR	389932	AR	389931	AR	389930	AR	389929	AR	389928	AR	389927	AR	389926	AR	389925	AR	389924	AR	389923	AR	389922	AR	389921	AR	389920	AR	389919	AR	389918	AR	389917	AR	389916	AR	389915	AR	389914	AR	389913	AR	389912	AR	389911	AR	389910	AR	389909	AR	389908	AR	389907	AR	389906	AR	389905	AR	389904	AR	389903	AR	389902	AR	389901	AR	389900	AR	389899	AR	389898	AR	389897	AR	389896	AR	389895	AR	389894	AR	389893	AR	389892	AR	389891	AR	389890	AR	389889	AR	389888	AR	389887	AR	389886	AR	389885	AR	389884	AR	389883	AR	389882	AR	389881	AR	389880	AR	389879	AR	389878	AR	389877	AR	389876	AR	389875	AR	389874	AR	389873	AR	389872	AR	389871	AR	389870	AR	389869	AR	389868	AR	389867	AR	389866	AR	389865	AR	389864	AR	389863	AR	389862	AR	389861	AR	389860	AR	389859	AR	389858	AR	389857	AR	389856	AR	389855	AR	389854	AR	389853	AR	389852	AR	389851	AR	389850	AR	389849	AR	389848	AR	389847	AR	389846	AR	389845	AR	389844	AR	389843	AR	389842	AR	389841	AR	389840	AR	389839	AR	389838	AR	389837	AR	389836	AR	389835	AR	389834	AR	389833	AR	389832	AR	389831	AR	389830	AR	389829	AR	389828	AR	389827	AR	389826	AR	389825	AR	389824	AR	389823	AR	389822	AR	389821	AR	389820	AR	389819	AR	389818	AR	389817	AR	389816	AR	389815	AR	389814	AR	389813	AR	389812	AR	389811	AR	389810	AR	389809	AR	389808	AR	389807	AR	389806	AR	389805	AR	389804	AR	389803	AR	389802	AR	389801	AR	389800	AR	389799	AR	389798	AR	389797	AR	389796	AR	389795	AR	389794	AR	389793	AR	389792	AR	389791	AR	389790	AR	389789	AR	389788	AR	389787	AR	389786	AR	389785	AR	389784	AR	389783	AR	389782	AR	389781	AR	389780	AR	389779	AR	389778	AR	389777	AR	389776	AR	389775	AR	389774	AR	389773	AR	389772	AR	389771	AR	389770	AR	389769	AR	389768	AR	389767	AR	389766	AR	389765	AR	389764	AR	389763	AR	389762	AR	389761	AR	389760	AR	389759	AR	389758	AR	389757	AR	389756	AR	389755	AR	389754	AR	389753	AR	389752	AR	389751	AR	389750	AR	389749	AR	389748	AR	389747	AR	389746	AR	389745	AR	389744	AR	389743	AR	389742	AR	389741	AR	389740	AR	389739	AR	389738	AR	389737	AR	389736	AR	389735	AR	389734	AR	38973
----	--------	----	--------	----	--------	----	--------	----	--------	----	--------	----	--------	----	--------	----	--------	----	--------	----	--------	----	--------	----	--------	----	--------	----	--------	----	--------	----	--------	----	--------	----	--------	----	--------	----	--------	----	--------	----	--------	----	--------	----	--------	----	--------	----	--------	----	--------	----	--------	----	--------	----	--------	----	--------	----	--------	----	--------	----	--------	----	--------	----	--------	----	--------	----	--------	----	--------	----	--------	----	--------	----	--------	----	--------	----	--------	----	--------	----	--------	----	--------	----	--------	----	--------	----	--------	----	--------	----	--------	----	--------	----	--------	----	--------	----	--------	----	--------	----	--------	----	--------	----	--------	----	--------	----	--------	----	--------	----	--------	----	--------	----	--------	----	--------	----	--------	----	--------	----	--------	----	--------	----	--------	----	--------	----	--------	----	--------	----	--------	----	--------	----	--------	----	--------	----	--------	----	--------	----	--------	----	--------	----	--------	----	--------	----	--------	----	--------	----	--------	----	--------	----	--------	----	--------	----	--------	----	--------	----	--------	----	--------	----	--------	----	--------	----	--------	----	--------	----	--------	----	--------	----	--------	----	--------	----	--------	----	--------	----	--------	----	--------	----	--------	----	--------	----	--------	----	--------	----	--------	----	--------	----	--------	----	--------	----	--------	----	--------	----	--------	----	--------	----	--------	----	--------	----	--------	----	--------	----	--------	----	--------	----	--------	----	--------	----	--------	----	--------	----	--------	----	--------	----	--------	----	--------	----	--------	----	--------	----	--------	----	--------	----	--------	----	--------	----	--------	----	--------	----	--------	----	--------	----	--------	----	--------	----	--------	----	--------	----	--------	----	--------	----	--------	----	--------	----	--------	----	--------	----	--------	----	--------	----	--------	----	--------	----	--------	----	--------	----	--------	----	--------	----	--------	----	--------	----	--------	----	--------	----	--------	----	--------	----	--------	----	--------	----	--------	----	--------	----	--------	----	--------	----	--------	----	--------	----	--------	----	--------	----	--------	----	--------	----	--------	----	--------	----	--------	----	--------	----	--------	----	--------	----	--------	----	--------	----	--------	----	--------	----	--------	----	--------	----	--------	----	--------	----	--------	----	--------	----	--------	----	--------	----	--------	----	--------	----	--------	----	--------	----	--------	----	--------	----	--------	----	--------	----	--------	----	--------	----	--------	----	--------	----	--------	----	--------	----	--------	----	--------	----	--------	----	--------	----	--------	----	--------	----	--------	----	--------	----	--------	----	--------	----	--------	----	--------	----	--------	----	--------	----	--------	----	--------	----	--------	----	--------	----	--------	----	--------	----	--------	----	--------	----	--------	----	--------	----	--------	----	--------	----	--------	----	--------	----	--------	----	--------	----	--------	----	--------	----	--------	----	--------	----	--------	----	--------	----	--------	----	--------	----	--------	----	--------	----	--------	----	--------	----	--------	----	--------	----	--------	----	--------	----	--------	----	--------	----	--------	----	--------	----	--------	----	--------	----	--------	----	--------	----	--------	----	--------	----	--------	----	--------	----	--------	----	--------	----	--------	----	--------	----	--------	----	--------	----	--------	----	--------	----	--------	----	--------	----	--------	----	--------	----	--------	----	--------	----	--------	----	--------	----	--------	----	--------	----	--------	----	--------	----	--------	----	--------	----	--------	----	--------	----	--------	----	--------	----	--------	----	--------	----	--------	----	--------	----	--------	----	--------	----	--------	----	--------	----	--------	----	--------	----	--------	----	--------	----	--------	----	--------	----	--------	----	--------	----	--------	----	--------	----	--------	----	--------	----	--------	----	--------	----	--------	----	--------	----	--------	----	--------	----	--------	----	--------	----	--------	----	--------	----	--------	----	--------	----	--------	----	--------	----	--------	----	--------	----	--------	----	--------	----	--------	----	--------	----	--------	----	--------	----	--------	----	--------	----	--------	----	--------	----	--------	----	--------	----	--------	----	--------	----	--------	----	--------	----	--------	----	--------	----	--------	----	--------	----	--------	----	--------	----	--------	----	--------	----	--------	----	--------	----	--------	----	--------	----	--------	----	--------	----	--------	----	--------	----	--------	----	--------	----	--------	----	--------	----	--------	----	--------	----	--------	----	--------	----	--------	----	--------	----	--------	----	--------	----	--------	----	--------	----	--------	----	--------	----	--------	----	--------	----	--------	----	--------	----	--------	----	--------	----	--------	----	--------	----	--------	----	--------	----	--------	----	--------	----	--------	----	--------	----	--------	----	--------	----	--------	----	--------	----	--------	----	--------	----	--------	----	--------	----	--------	----	--------	----	--------	----	--------	----	--------	----	--------	----	--------	----	--------	----	--------	----	--------	----	--------	----	--------	----	--------	----	--------	----	--------	----	--------	----	--------	----	--------	----	--------	----	--------	----	--------	----	--------	----	--------	----	--------	----	--------	----	--------	----	--------	----	--------	----	--------	----	--------	----	--------	----	--------	----	--------	----	--------	----	--------	----	--------	----	--------	----	--------	----	--------	----	--------	----	--------	----	--------	----	--------	----	--------	----	--------	----	--------	----	--------	----	--------	----	--------	----	--------	----	--------	----	--------	----	--------	----	--------	----	--------	----	--------	----	--------	----	--------	----	--------	----	--------	----	--------	----	--------	----	--------	----	--------	----	--------	----	--------	----	--------	----	--------	----	--------	----	--------	----	--------	----	--------	----	--------	----	--------	----	--------	----	--------	----	--------	----	--------	----	--------	----	--------	----	--------	----	--------	----	--------	----	--------	----	--------	----	--------	----	--------	----	--------	----	--------	----	--------	----	--------	----	--------	----	--------	----	--------	----	--------	----	--------	----	--------	----	--------	----	--------	----	--------	----	--------	----	--------	----	--------	----	--------	----	--------	----	--------	----	--------	----	--------	----	--------	----	--------	----	--------	----	--------	----	--------	----	--------	----	--------	----	--------	----	--------	----	--------	----	--------	----	--------	----	--------	----	--------	----	--------	----	--------	----	--------	----	--------	----	--------	----	--------	----	--------	----	--------	----	--------	----	--------	----	--------	----	--------	----	--------	----	--------	----	--------	----	--------	----	--------	----	--------	----	--------	----	--------	----	--------	----	--------	----	--------	----	--------	----	--------	----	--------	----	--------	----	--------	----	--------	----	--------	----	--------	----	--------	----	--------	----	--------	----	--------	----	--------	----	--------	----	--------	----	--------	----	--------	----	--------	----	--------	----	--------	----	--------	----	--------	----	--------	----	--------	----	--------	----	--------	----	--------	----	--------	----	--------	----	--------	----	--------	----	--------	----	--------	----	--------	----	--------	----	--------	----	--------	----	--------	----	--------	----	--------	----	--------	----	--------	----	-------

Since the load banks absorb 100% of their rating as soon as voltage is applied regardless of air flow, it is necessary to install them properly to prevent damage or malfunctions. Outlined below are some practices which should be followed.

- AIR FLOW** - The air flow through all sections of the load bank should be at least 800 ft/min. and preferably 1000 ft/min. or greater. The air flow should not be blocked from some sections of the load bank or the load bank installed so there are areas of "dead" air. See Bulletin 203 for method of air flow computation.

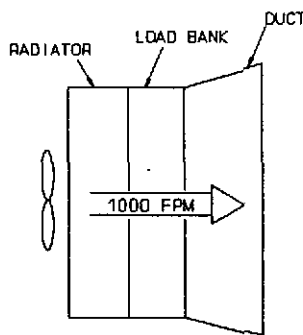

RIGHT

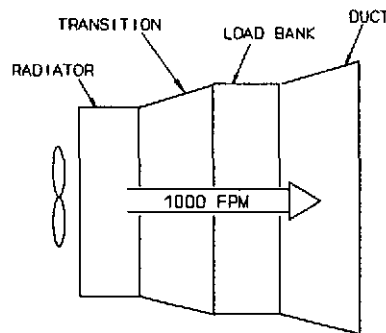

RIGHT

(PREFERRED IF OVERSIZED
 LOAD BANK IS REQUIRED)

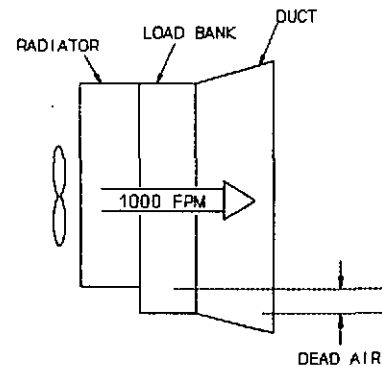

WRONG

- THERMAL PROTECTORS** - When thermal protectors are included as a part of the unit, the load bank should always be installed with the thermal protector at the top.

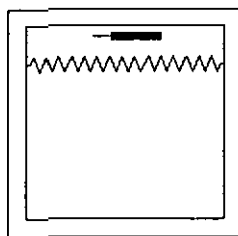

RIGHT

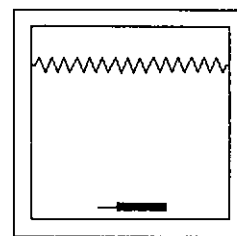

WRONG

BULLETIN 202
INSTALLATION NOTES
ENGINE GENERATOR DUCT
TYPE LOAD BANKS
Page 2 of 2

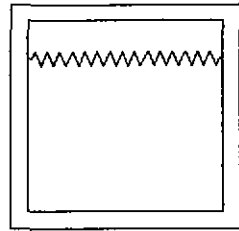

RIGHT

LOAD
ELEMENT

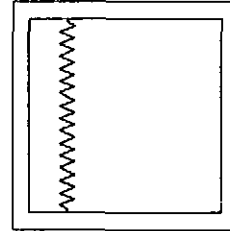

WRONG

3. **ELEMENT POSITION** - The elements are designed for horizontal installation to prevent sagging or movement that would cause damage. The load bank should be installed with the elements horizontal, as shown above.
4. **RATED CURRENT AND FUSING** - When installing the load bank, it is necessary to provide the proper size wire and, if fuses are required, they must be selected so they are compatible with the load steps and voltage applied to the unit. The current drawn by the load bank may be computed from the formula:

$$I = \frac{KW \times 577}{\text{Voltage (Line-to-Line)}}$$

For example, a 100 KW load bank will draw 120 amperes at 480 volts and 240 amperes at 240 volts. For the low voltage installation, the fuse rating and wire size must have twice the current capacity of the high voltage installation. Load banks can be installed with a load connected as a single step or multiple small steps, and the fuses and wire size should be selected accordingly.

5. **PARTIAL DUCT INSTALLATIONS** - There may be installations where only a small amount of load is required relative to the generator rating and duct size. Avtron recommends that a load bank be selected which is large enough to match the size of the engine air duct. If this is not feasible, a smaller load bank can be used which will only fill a part of the duct. Under these circumstances, it is the installer's responsibility to insure that sufficient air passes through the load bank for proper cooling.

I. AIRFLOW CALCULATIONS

Load Banks are designed to operate with air passing over the load elements at a rate of approximately 1,000 ft./min. (5.08 meters/sec.). They will withstand higher air velocity without any problems as far as the Load Bank is concerned; however, the pressure drop across the Load Bank will increase. Therefore, this must be considered when selecting a Load Bank. When the air velocity is a great deal less than 1,000 ft./min., the load elements will operate at a higher temperature, which results in shorter life. At very low air velocity, the elements will overheat and be destroyed.

Outlined below are simple methods of computing air velocity, pressure drop, and temperature rise for the Avtron K711 series duct type Load Banks.

A. AIR VELOCITY COMPUTATIONS

When selecting a duct type Load Bank, the engine radiator parameters such as size and airflow are known. The Load Bank frame with dimensions closest to the effective dimensions of the radiator should be considered. For a given engine configuration, the airflow in cubic feet per minute or liters per second is supplied by the engine manufacturer. The velocity is calculated by using the effective area of the Load Bank and the engine airflow.

$$\text{Velocity (Ft. per Min.)} = \frac{\text{Engine Airflow (cu. ft./min.)} \times 144}{\text{Load Bank Width (in)} \times \text{Load Bank Height (in)}}$$

$$\text{Velocity (meters/sec.)} = \frac{\text{Engine Airflow (Liters/Sec.)} \times 10}{\text{Load Bank Width (cm)} \times \text{Load Bank Height (cm)}}$$

B. PRESSURE DROP

The Avtron K711 series of Load Banks are designed to be compatible with typical radiator sizes and airflows. One important criterion in application of the Load Banks is the air pressure drop through the Load Bank. The engine generator sets are usually designed with sufficient fan capacity to provide a head of .5 in. H₂O (12.7mm H₂O) after the air has passed through the radiator. The Load Banks are designed to minimize the cooling air pressure drop. Typically, the louver type Load Banks have a pressure drop of about .2 in. H₂O (5.08mm H₂O) and the duct types have a drop of about .1 in. H₂O (2.54mm H₂O) at minimum rated airflow.



C. AIR TEMPERATURE RISE

In some installations, the allowable exhaust air temperature from the overall engine generator and Load Bank combination must be limited to a specific value. The temperature rise information on the engine generator combination can be supplied by the manufacturer. The air temperature rise through the Load Bank can be calculated from the following formula:

$$\text{Temp Rise (° F)} = \frac{\text{Load Bank KW} \times 3200}{\text{CFM}}$$

$$\text{Temp Rise (° C)} = \frac{\text{Load Bank KW} \times 570}{\text{Liters/Sec.}}$$

Depending on the installation, the cooling system exhaust air temperature rise may be compiled using the Load Bank temperature rise derived from the above calculation and adding it to the other system temperature rises.

II. ELECTRICAL CALCULATIONS

A. RATING

The Load Bank power ratings are based on the highest rated operating voltage. Each load step consists of two elements, each rated at 138 volts connected in wye. When connected in the series configuration, the Load Bank may be used on 480 V or 380 V, 3 Phase. With 480 volts applied to the terminals, 138 volts is applied to each element. When connected in parallel configuration, the Load Bank may be used on 240 V or 208 V, 3 Phase systems. With 240 V, 3 Phase applied to the terminals, 138 volts is applied to each element. The load absorbed by the Load Bank at other than rated voltage can be computed from the formula:

$$\text{Absorbed KW} = \frac{\text{Rated KW} \times (\text{Applied Voltage})^2}{(\text{RATED VOLTAGE})^2}$$

For example, a 100 KW Load Bank connected for 240 volts with 208 volts applied will absorb 75 KW.

$$\text{Absorbed KW} = \frac{100 \times (208)^2}{(240)^2}$$

B. CURRENT CALCULATIONS

To determine the wire size and fuse ratings for a given installation, it is necessary to determine the line current. This can be readily determined from the formula:

$$\text{Phase Current} = \frac{\text{Absorbed KW} \times 577}{\text{Applied Voltage (Line-to-Line)}}$$

For example, a 100 KW load with 480 volts applied will draw 120 amperes per phase.

$$\text{Phase Current} = \frac{100 \times 577}{480}$$

C. REACTIVE LOAD CALCULATIONS

When engine generator sets are operated with Resistive (KW) load, they are being tested at unity (1.0) Power Factor. Some load tests require operation at lower power factors, usually .8 PF. To perform these tests requires a load with both Resistive (KW) and Reactive (KVAR) capability. The Resistive and Reactive parts of the total load add vectorially, not directly. For example, to load a 100 KW generator at .8 Power Factor requires a Resistive load with a capacity of 100 KW and a Reactive load of 75 KVAR. The total load (Resistive and Reactive) on the generator is expressed as Volt-Amperes (KVA) and is the product of current times voltage. Using the above example of 100 KW Resistive load and 75 KVAR Reactive load, the total load (KVA) on the generator is 125 KVA.

When the generator set rating is expressed in terms of Resistive load at a certain power factor (100 KW at .8 PF), the total load (KVA) and Reactive load (KVAR) can be calculated as outlined below.

$$\text{Total Load (KVA)} = \frac{\text{Resistive Load (KW)}}{\text{Power Factor}}$$

$$\text{KVA} = \frac{100}{.8} = 125$$



$$\begin{aligned}\text{Reactive Load} &= \sqrt{(\text{KVA})^2 - (\text{KW})^2} \\ &= \sqrt{(125)^2 - (100)^2} \\ &= \sqrt{15625 - 10000} \\ &= \sqrt{5625} = 75 \text{ KVAR}\end{aligned}$$

Warranty

Warranty and Duration

For a period of one year after installation, or fifteen (15) months from date of shipment from our plant, whichever is shorter, Avtron warrants the equipment, except as hereinafter provided, to be free from harmful defects in material and workmanship. Notwithstanding any other term or provision in this Warranty, the warranty provided herein shall terminate unless buyer notifies Avtron, in writing, of a breach hereof within the warranty period; any claims not made within such period are waived by Buyer. The warranty provided herein applies only if Buyer complies with all the other terms and provisions of this Warranty.

Uses of Equipment

The warranty provided herein applies only if the equipment has been used in a normal and proper manner under recommended conditions. Notwithstanding any advice or assistance given to the Buyer by Avtron or its suppliers concerning the equipment or its use, Avtron makes no express or implied warranties or representations, except as herein expressly provided, with respect to the equipment or its use, and Avtron shall not be liable in contract, warranty or tort (including, without limitation, for negligence or strict liability) as a result of such advice or assistance. In addition, unless otherwise agreed in writing signed by a duly authorized representative of Avtron, no equipment covered by this warranty is intended to be used in connection with any nuclear facility or activity, and if so used, Avtron disclaims any and all liability for any damage resulting therefrom.

Notification of Breach

When claiming a breach of this Warranty, Buyer must promptly (within 10 days from the date of the discovery of the defect) notify Avtron in writing.

Equipment Disposition

Upon notification of a claimed breach of this Warranty, Avtron, at its discretion, will either authorize the return of the defective equipment or part thereof (transportation costs to be prepaid by Buyer) or provide a suitable replacement or authorize the Buyer in writing to effect repairs at Avtron's expense. In the event that the equipment returned as authorized is found to be defective and Avtron elects to repair or replace said equipment, Avtron will pay the transportation costs associated with the return of said equipment to Buyer. Avtron shall not however be liable for any customs, tariffs, duties or taxes incurred in shipping equipment pursuant to this Warranty. These shall be the responsibility of the Buyer.

Option of Avtron to Repair or Replace Equipment or to Issue Credit

Avtron's sole obligation under this Warranty shall be, at the option of Avtron, to replace or repair any defective equipment or part thereof or to issue a credit with respect to the defective equipment equal to the purchase price thereof less depreciation.

Equipment Excluded From Warranty

The warranty provided herein specifically excludes equipment and components that Avtron purchases and resells as part of a system, product or spare part order. The warranties provided to Avtron by the manufacturers of the foregoing equipment and components will, to the extent possible, be passed on to the Buyer. Copies of such warranties, if on file at Avtron, will be made available for inspection upon the request of Buyer. Equipment such as, but not limited to, computers, CRTs, operator interface modules, monitors, etc., normally have a short warranty period and should be covered by a continuous service contract generally available from the original manufacturer at a reasonable cost. Consumable items including, but not limited to, lamps, filters, fuses and motor brushes are excluded from all warranties. Other items or components may be excluded from this warranty if so noted in the governing purchase order or contract.

Resale or Lease of Equipment

In the event that the Buyer resells or leases equipment purchased from Avtron, the Buyer shall obtain the signed written agreement of the purchaser or lessee thereof that Avtron's only liability with respect to said equipment is as set forth in this Warranty. In the event that the Buyer fails to obtain such a signed written agreement, the Buyer agrees to indemnify Avtron against any claims, demands, judgments, suits, costs, liabilities and expenses (including reasonable attorney's fees) incurred by Avtron as a result of such failure.

Unauthorized Repairs

Unless otherwise agreed in writing signed by a duly authorized representative of Avtron, if the Buyer has repairs or modifications made to equipment covered by this Warranty by a person other than an authorized Avtron service representative, Avtron shall not be liable for any expenses incurred in connection therewith and the warranty provided herein shall automatically be terminated.

Governing Law; Saving Clause

This Warranty is part of the terms and conditions of the sale of the equipment covered hereunder and shall be governed by and enforced in accordance with the laws of the State of Ohio. Any provision hereof which is prohibited or unenforceable in any jurisdiction shall, as to such jurisdiction, be ineffective to the extent of such prohibition or unenforceability without invalidating the remaining provisions hereof or affecting the validity or enforceability of such provision in any other jurisdiction.

Limitation of Liability

IN NO EVENT SHALL AVTRON BE LIABLE IN CONTRACT, IN TORT OR OTHERWISE FOR SPECIAL, INCIDENTAL, CONSEQUENTIAL OR PUNITIVE DAMAGES (INCLUDING, BUT NOT LIMITED TO, LOSS OF PROFITS OR REVENUES, LOSS OF USE OF THE EQUIPMENT OR ANY DAMAGE TO ASSOCIATED EQUIPMENT, DAMAGE OR INJURY TO PERSONS OR PROPERTY, COST OF CAPITAL, COST OF SUBSTITUTE OR TEMPORARY EQUIPMENT, DOWNTIME OR CLAIMS OF CUSTOMERS) ARISING OUT OF OR AS A RESULT OF BREACH OF WARRANTY, DEFECT IN MATERIAL OR WORKMANSHIP OR ANY OTHER OBLIGATION OF AVTRON HEREUNDER.

Disclaimer of All Other Warranties

THIS WARRANTY COMPRISES AVTRON'S SOLE AND ENTIRE WARRANTY OBLIGATION TO BUYER, ITS CUSTOMERS AND ASSIGNS IN CONNECTION WITH EQUIPMENT SOLD, ASSIGNED, LEASED OR OTHERWISE DEALT WITH BY AVTRON. ALL OTHER WARRANTIES, EXPRESS OR IMPLIED, INCLUDING, BUT NOT LIMITED TO, WARRANTIES OF MERCHANTABILITY AND FITNESS, ARE EXPRESSLY EXCLUDED.

