



## Instructions for Cutler-Hammer Closed Transition Drawout Transfer Switch and Bypass Isolation Switch







**WARNING**

READ AND UNDERSTAND THE INSTRUCTIONS CONTAINED HEREINAFTER BEFORE ATTEMPTING TO UNPACK, ASSEMBLE, OPERATE OR MAINTAIN THIS EQUIPMENT.

HAZARDOUS VOLTAGES ARE PRESENT INSIDE TRANSFER SWITCH ENCLOSURES THAT CAN CAUSE DEATH OR SEVERE PERSONAL INJURY. FOLLOW PROPER INSTALLATION, OPERATION AND MAINTENANCE PROCEDURES TO AVOID THESE VOLTAGES.

TRANSFER SWITCH EQUIPMENT COVERED BY THIS INSTRUCTION BOOK IS DESIGNED AND TESTED TO OPERATE WITHIN ITS NAMEPLATE RATINGS. OPERATION OUTSIDE OF THESE RATINGS MAY CAUSE THE EQUIPMENT TO FAIL RESULTING IN DEATH, SERIOUS BODILY INJURY AND/OR PROPERTY DAMAGE. ALL RESPONSIBLE PERSONNEL SHOULD LOCATE THE DOOR MOUNTED EQUIPMENT NAMEPLATE AND BE FAMILIAR WITH THE INFORMATION PROVIDED ON THE NAMEPLATE. A TYPICAL EQUIPMENT NAMEPLATE IS SHOWN IN FIGURE 1.

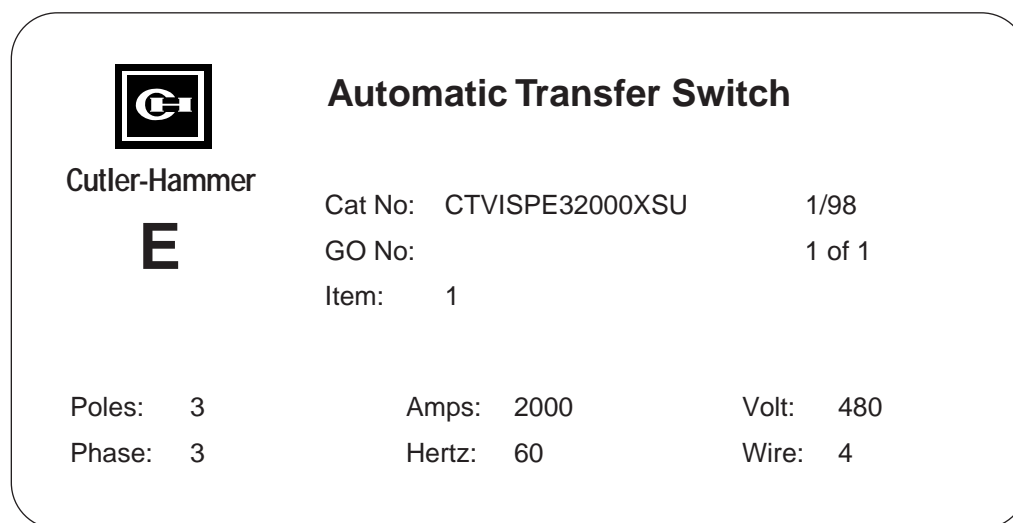

Figure 1 Typical Automatic Transfer Switch Equipment Nameplate

*All possible contingencies which may arise during installation, operation or maintenance, and all details and variations of this equipment do not purport to be covered by these instructions. If further information is desired by purchaser regarding his particular installation, operation or maintenance of particular equipment, contact a Cutler-Hammer representative.*

TABLE OF CONTENTS

	<b>PAGE</b>
<b>SECTION 1: INTRODUCTION</b>	
1.1 Preliminary Comments and Safety Precautions.....	1
1.1.1 Warranty and Liability Information.....	1
1.1.2 Safety Precautions.....	1
1.2 General Information.....	1
1.2.1 Transfer Switch Types.....	2
1.2.2 Design Configuration.....	4
1.3 Transfer Switch Catalog Number Identification.....	4
 <b>SECTION 2: RECEIVING, HANDLING AND STORAGE</b>	
2.1 Receiving.....	6
2.2 Handling.....	6
2.3 Storage.....	6
 <b>SECTION 3: EQUIPMENT DESCRIPTION</b>	
3.1 General.....	7
3.2 Power Panel.....	7
3.2.1 Main Contacts.....	7
3.2.2 Drawout Interlocks.....	8
3.2.3 Transfer Mechanism.....	8
3.2.4 Drawout Mechanism.....	9
3.3 Voltage Selection Panel.....	9
3.4 Logic Panel.....	9
3.5 Neutrals.....	9
3.6 Options (Non-Logic Panel).....	10
3.7 Enclosure.....	12
3.8 Standards.....	12
 <b>SECTION 4: INSTALLATION AND WIRING</b>	
4.1 General.....	14
4.2 Mounting Location.....	14
4.3 Mounting Procedure.....	14
4.4 Power Cable Connections.....	17
4.5 Voltage Selection Adjustment.....	18
4.6 Mounting Switching Device in the Drawout Mechanism.....	18
4.7 Wiring.....	20
4.7.1 Engine Start Connection.....	21
4.7.2 Alarm Contacts.....	21
 <b>SECTION 5: OPERATION</b>	
5.1 General.....	22
5.2 Automatic Transfer Switch.....	22

**PAGE**

**SECTION 6: DRAWOUT MECHANISM**

6.1 Drawout Interlock .....24  
 6.2 Switch Position .....24  
 6.3 Rotation on the Drawout.....24  
 6.4 Operational Check for Drawout Mechanism.....25

**SECTION 7: OPERATION OF BYPASS ISOLATION TRANSFER SWITCH**

7.1 Operator Panel .....26  
 7.2 Automatic Operation.....26  
 7.3 Bypassing the Transfer Switch.....27  
     7.3.1 Normal to Normal Bypass .....27  
     7.3.2 Emergency to Emergency Bypass .....27  
 7.4 Manual Operation when in Bypass Mode.....30  
     7.4.1 Normal Bypass to Emergency Bypass .....30  
     7.4.2 Emergency Bypass to Normal Bypass .....30

**SECTION 8: TESTING AND PROBLEM SOLVING**

8.1 Testing .....31  
 8.2 Problem Solving .....31  
     8.2.1 Transfer Switch Appears Inoperative .....32  
     8.2.2 Transfer Switch will not Automatically Transfer to Normal .....32  
     8.2.3 Transfer Switch will not Automatically Transfer to Emergency .....32  
     8.2.4 Transfer Switch will not Automatically Recharge Switches .....32

**SECTION 9: MAINTENANCE**

9.1 Introduction.....33  
 9.2 Procedures .....33

## LIST OF FIGURES

Figure	Title	Page
1-1	Typical Load Transfer Switch (circuit breaker type) Schematic.....	2
1-2	Typical Bypass Isolation Switch.....	3
1-3	Typical Bypass Isolation Switch Schematic.....	3
1-4	Typical Drawout Transfer Switch with Deadfront Attached.....	4
3-1	Typical Power Panel.....	7
3-2	Insulated Case Circuit Breaker.....	7
3-3	Side View and Rear View of Power Panel.....	8
3-4	Drawout Mechanism.....	9
3-5	Voltage Selection Panel.....	9
3-6	IQ Transfer.....	10
3-7	Neutral Connection.....	10
3-8	Charger Mounting Dimensions in Inches (mm).....	11
3-9	Typical Switch Enclosure.....	12
4-1	Enclosed Drawout Transfer Switch (NEMA 1 Enclosure).....	15
4-2	Enclosed Bypass Isolation Transfer Switch (NEMA 1 Enclosure).....	16
4-3	Side View and Rear View of Power Panel.....	18
4-4	Drawout Stationary.....	20
4-5	Seismic Tested and Approved Product Mounting Instructions.....	19
4-6	Secondary Control Block Contact Opening.....	20
4-7	Correct Placement.....	20
5-1	Pumping Handle Charges Stored Energy Mechanism.....	22
5-2	Switching Device Closing Precautions.....	23
6-1	Drawout with Socket Wrench.....	24
6-2	Drawout Rotated Out for Inspection.....	24
6-3	Drawout Returned to Upright Position.....	25
7-1	Bypass Isolation Switch.....	26
7-2a	Transfer from Normal Switching Device to Normal Bypass Switching Device, Steps 1-4.....	28
7-2b	Transfer from Normal Switching Device to Normal Bypass Switching Device, Steps 5-8.....	29

## LIST OF TABLES

Table	Title	Page
1.1	Withstand Ratings.....	3
1.2	Transfer Switch Catalog Number Explanation.....	5
3.1	Transfer Switch Equipment Enclosures.....	12
4.1	Wire Size for Power Cable Connections.....	18
9.1	Periodic Maintenance Procedures.....	34

## SECTION 1: INTRODUCTION

### 1.1 PRELIMINARY COMMENTS AND SAFETY PRECAUTIONS

This technical document is intended to cover most aspects associated with the installation, application, operation and maintenance of transfer switch equipment with ratings from 600 through 4000 amperes, except for the specific logic used to control the equipment. It is provided as a guide for authorized and qualified personnel only. Please refer to the specific WARNING and CAUTION in Section 1.1.2 before proceeding. If further information is required by the purchaser regarding a particular installation, application or maintenance activity, a Cutler-Hammer representative should be contacted. For information associated with the control, refer to the separate instruction book pertaining to the logic package installed in the switch.

#### 1.1.1 WARRANTY AND LIABILITY INFORMATION

No warranties, expressed or implied, including warranties of fitness for a particular purpose of merchantability, or warranties arising from course of dealing or usage of trade, are made regarding the information, recommendations and descriptions contained herein. In no event will Cutler-Hammer be responsible to the purchaser or user in contract, in tort (including negligence), strict liability or otherwise for any special, indirect, incidental or consequential damage or loss whatsoever, including but not limited to damage or loss of use of equipment, plant or power system, cost of capital, loss of power, additional expenses in the use of existing power facilities, or claims against the purchaser or user by its customers resulting from the use of the information and descriptions contained herein.

#### 1.1.2 SAFETY PRECAUTIONS

All safety codes, safety standards and/or regulations must be strictly observed in the installation, operation and maintenance of this device.



### WARNING

**THE WARNINGS AND CAUTIONS INCLUDED AS PART OF THE PROCEDURAL STEPS IN THIS DOCUMENT ARE FOR PERSONNEL SAFETY AND PROTECTION OF EQUIPMENT FROM DAMAGE. AN EXAMPLE OF A TYPICAL WARNING LABEL HEAD-ING IS SHOWN ABOVE TO FAMILIARIZE PERSON-**

**NEL WITH THE STYLE OF PRESENTATION. THIS WILL HELP TO INSURE THAT PERSONNEL ARE ALERT TO WARNINGS, WHICH APPEAR THROUGHOUT THE DOCUMENT. IN ADDITION, CAUTIONS ARE ALL UPPER CASE AND BOLDFACE.**



### CAUTION

**COMPLETELY READ AND UNDERSTAND THE MATERIAL PRESENTED IN THIS DOCUMENT BEFORE ATTEMPTING INSTALLATION, OPERATION OR APPLICATION OF THE EQUIPMENT. IN ADDITION, ONLY QUALIFIED PERSONS SHOULD BE PERMITTED TO PERFORM ANY WORK ASSOCIATED WITH THE EQUIPMENT. ANY WIRING INSTRUCTIONS PRESENTED IN THIS DOCUMENT MUST BE FOLLOWED PRECISELY. FAILURE TO DO SO COULD CAUSE PERMANENT EQUIPMENT DAMAGE.**



### WARNING

**THIS PRODUCT CONTAINS A SPECIAL CONTACT ARRANGEMENT (OVERLAPPING CONTACTS). MISUSE CAN RESULT IN DEATH, SEVERE PERSONAL INJURY AND/OR PROPERTY DAMAGE.**

### 1.2 GENERAL INFORMATION

Transfer switches are used to protect critical electrical loads against loss of power. The normal power source of the load is backed-up by a secondary (emergency) power source. A transfer switch is connected to both the normal and emergency power sources and supplies the load with power from one of these two sources (Figure 1-1).

The Cutler-Hammer Closed Transition Transfer Switch, CTVISP, is applied where it is desirable to avoid any momentary power interruptions. Although the CTVISP is not a substitute for a UPS, it does eliminate power interruptions to loads except to those caused by power sources or equipment external to the transfer switch. If both sources are acceptable as determined by the IQ Transfer logic, the CTVISP performs a make-before-break transfer during a transfer test or returning to the normal source.

In automatic transfer switch equipment, the switch's intelligence system initiates the transfer when normal power fails or falls below a preset voltage. If the emergency power source is a standby generator, the transfer switch initiates generator starting and transfers to the

emergency power source when sufficient generator voltage is available. When normal power is restored, the transfer switch automatically transfers back and initiates engine shutdown. In the event the normal power source fails and the emergency power source does not appear, the automatic transfer switch remains connected to the normal power source until the emergency power source does appear. Conversely, if connected to the emergency power source and the emergency power source fails while the normal power source is still unavailable, the automatic transfer switch remains connected to the emergency power source.

### 1.2.1 TRANSFER SWITCH TYPES

In general, there are four types of basic transfer switch equipment:

#### **Automatic Transfer Switch**

Automatic transfer switches automatically perform the transfer function. They consist of three basic elements:

- (1) Main contacts to connect and disconnect the load to and from the source of power.
- (2) Intelligence/supervisory circuits to constantly monitor the condition of the power sources and thus provide the intelligence necessary for the switch and related circuit operation.

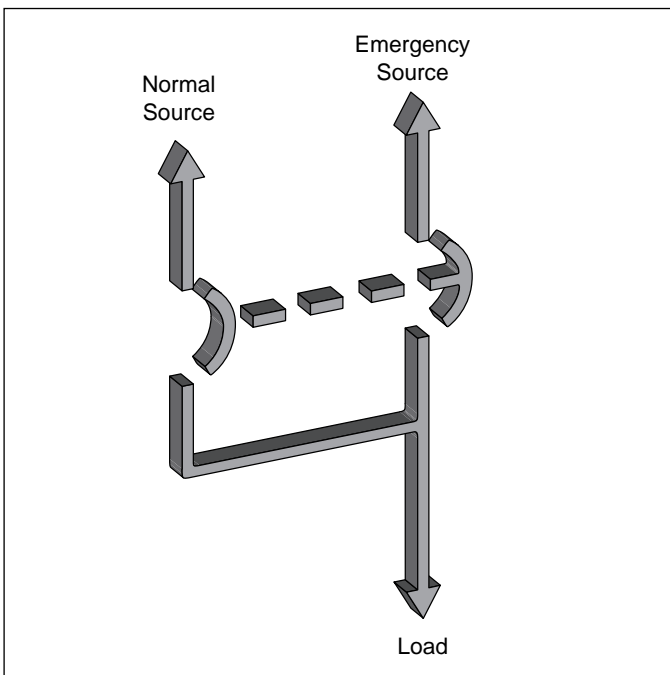

Figure 1-1 Typical Load Transfer Switch (circuit breaker type) Schematic

- (3) A transfer mechanism to effect the transfer of the main contacts from source to source.

#### **Basic Transfer Switch**

The basic transfer switch is designed for use with customer furnished logic. It is similar in design to the automatic version except the intelligence circuit (logic panel) and voltage selection panel are omitted. All automatic sensing devices, relays or solid state devices are the customer's responsibility.

#### **Non-Automatic Transfer Switch (Manually Operated)**

Non-Automatic transfer switches provide the main contacts and the transfer mechanism to effect the transfer of the main contacts from source to source. Transfer of power, however, is accomplished by true hand operation (not power assisted) of the transfer switch. This switch is similar to the basic switch in that an intelligence circuit and a motor driven mechanism are not part of the design.

#### **Non-Automatic Transfer Switch (Electrically Operated)**

This transfer switch is similar to the Non-Automatic Transfer Switch (Manually Operated) just described except that an electrical operation feature is added. The switch electrically transfers power when an appropriate pushbutton on the front of the enclosure is pushed. If necessary, the switch can also be operated manually.

In addition to the four basic switch types just discussed, there is a specialized design called the **Bypass Isolation Transfer Switch**.

#### **Bypass Isolation Transfer Switch**

The bypass isolation switch is designed for applications where maintenance, inspection and testing must be performed while maintaining continuous power to the load (Figures 1-2 and 1-3). This is typically required in critical life support systems and standby power situations calling for safe system maintenance with no power disruptions. Such a design allows for the quick removal of the different switching devices for inspection, maintenance or replacement.

The automatic transfer switch, non-automatic transfer switch (electrically operated) and bypass isolation transfer switch are the available types for the configuration described in this manual.

Operation of the automatic transfer switch and the bypass isolation switch are only discussed in this manual (Sections 5 and 7 respectively).

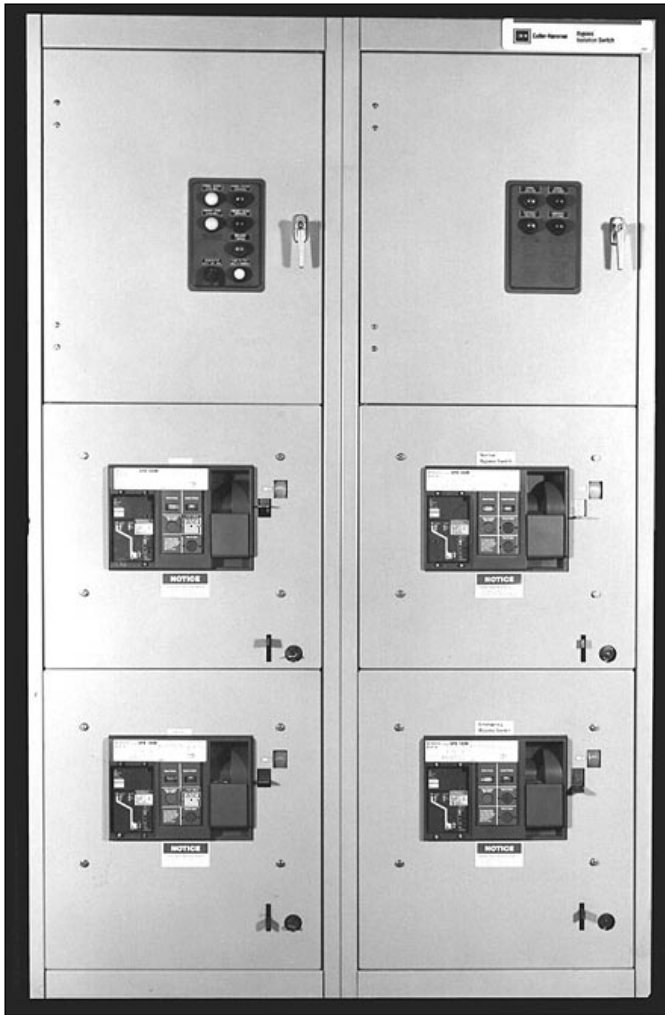

Figure 1-2 Typical Bypass Isolation Switch

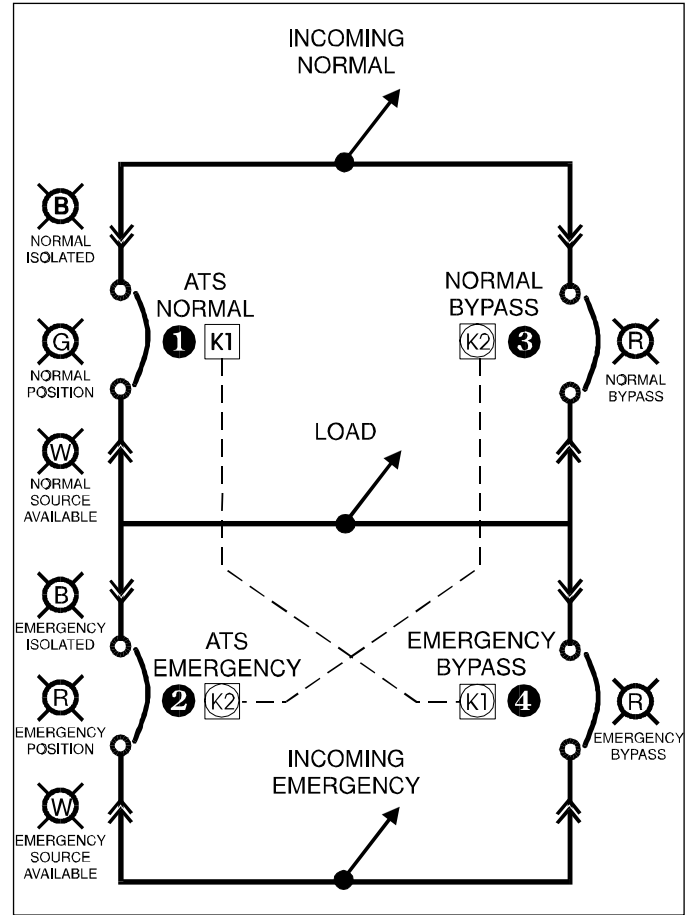

Figure 1-3 Typical Bypass Isolation Switch Schematic

Table 1.1 Withstand Ratings

Rating When Used with Upstream Circuit Breaker					Rating When Used with Upstream Fuse		
Transfer Switch Amp Rating	Option 17C Selected	240V (kA)	480V (kA)	600V (kA)	Maximum Fuse Rating	Fuse Type	600V max. (kA)
600	No	85	65	25	800/1200	L	200
800	No	85	65	25	1200/1600	L	200
1000	No	85	65	25	1600	L	200
1200	No	85	65	25	2000	L	200
600	Yes	100	100	85	800/1200	L	200
800	Yes	100	100	85	1200/1600	L	200
1000	Yes	100	100	85	1600	L	200
1200	Yes	100	100	85	2000	L	200
1600		100	100	85	3000	L	200
2000		100	100	85	3000	L	200
2500		100	100	85	4000	L	200
3000		100	100	85	4000	L	200
4000		100	100	85	5000	L	200

### 1.2.2 DESIGN CONFIGURATION

The Cutler-Hammer transfer switch is a rugged, compact design utilizing insulated case switches or insulated case circuit breakers to transfer essential loads from one power source to another (Figures 1-2 and 1-3). The versatile design, in addition to standard transfer functions, offers an optional integral thermal and short circuit protection in either or both switching devices.

The switching devices are in a compact vertical arrangement. The logic can be easily disconnected from the switching device without disturbing critical connections. The enclosure is free standing, and, by using the specially supplied cleats, the switch is seismic approved (Option 42). The terminals are mounted in the rear of the switch, permitting rear, top, bottom or side cable or bus bar entrance.

The switching devices have a high withstand rating (Table 1.1). The high-speed, stored-energy switching mechanism guarantees a transfer time of less than 5 cycles.

### 1.3 TRANSFER SWITCH CATALOG NUMBER IDENTIFICATION

Transfer switch equipment catalog numbers provide a significant amount of relevant information that pertains to a particular piece of equipment. The catalog number identification table (Table 1.2) provides the required interpretation information. An example is offered to initially simplify the process.

**Example:** Catalog number (circled numbers correspond to position headings in Table 1.2):

① to ② ③ ④ ⑤ to ⑥ ⑦ ⑧ ⑨ to ⑫ ⑬ ⑭ ⑮  
**CT V I SP E 3 1000 X S U**

The catalog number CTVISPE31000XSU describes a closed transition automatic transfer switch with the switching devices mounted vertically in the enclosure. The intelligence represented by the IQ Transfer is a microprocessor-based logic package. The System Power Breaker (SPB) is used as the switching device and is a 3-pole insulated case switch for each source. The continuous current rating of this equipment is 1000 amperes and applicable at 480 VAC, 60Hz. The transfer switch equipment is enclosed in a NEMA 1 enclosure and is UL listed.



Figure 1-4 Typical Drawout Transfer Switch with Deadfront Attached

Table 1.2 Transfer Switch Catalog Number Explanation

Positions 1-2	Position 3	Position 4	Positions 5-6
Configuration	Switching Device Orientation	Control Panel	Switching Device
Closed Transition Automatic Transfer Switch CT	Vertical V	IO Transfer I	SPB Systems Power Breaker SP

Position 7	Position 8	Positions 9-12	Position 13	Position 14	Position 15
Switching Device Arrangement	Number of Poles	Ampere Rating	Voltage/Frequency	Enclosure Type	Listing
Drawout Insulated Case Switches both Sources E	Two 2	0600	120VAC/60Hz A	No Enclosure K	UL Listed U
	Three 3	0800	208VAC/60Hz B	Type 1 S	
	Four 4	1000	600VAC/60Hz E	Type 3R R <sup>①</sup>	
Drawout Insulated Case Breakers both Sources F		1200	220VAC/50 or 60Hz G	Type 4 L	
		1600	380VAC/50Hz H	Type 4X D	
		2000	600VAC/50Hz K	Type 12 J	
		2500	230VAC/50Hz M		
Drawout Insulated Case Breaker Normal Source, Insulated Switch Emergency Source G		3000	401VAC/50Hz N		
		4000	415VAC/50Hz O		
			240VAC/60Hz W		
Drawout Insulated Case Switch Normal Source, Insulated Breaker Emergency Source H			480VAC/60Hz X		
			365VAC/50Hz Z		

① Not available in bypass isolation (BU) versions.

## SECTION 2: RECEIVING, HANDLING AND STORAGE

### 2.1 RECEIVING

Every effort is made to insure that transfer switch equipment arrives at its destination undamaged and ready for installation. Crating and packing is designed to protect internal components as well as the enclosure. Transfer switch enclosures are skid mounted and suited for fork lift movement. Care should be exercised, however, to protect the equipment from impact at all times. Do not remove protective packaging until the equipment is ready for installation.

When transfer switch equipment reaches its destination, the customer should inspect the shipping container for any obvious signs of rough handling and/or external damage incurred during the transportation phase. Record any external and internal damage observed for reporting to the transportation carrier and Cutler-Hammer, once a thorough inspection is completed. All claims should be as specific as possible and include shop order and general order numbers.

A shipping label is affixed to the top of the shipping container which includes a variety of equipment and customer information, such as General Order Number (GO#) and Catalog Number (Cat#). Make certain that this information matches other shipping paper information.

Each transfer switch enclosure is bolted to a rigid wooden pallet. The pallet is open at two ends for movement by a fork lift. The shipment is secured and further protected with shrink wrap. Do not discard the packing material until the equipment is ready for installation.

A plastic bag of documents will be found within the enclosure, usually attached to the inside of the door. Important documents, such as test reports, wiring diagrams, appropriate instruction leaflets and a warranty registration card, are enclosed within the bag and should be filed in a safe place.

### 2.2 HANDLING

As previously mentioned, transfer switch equipment is packaged for fork lift movement. Protect the equipment from impact at all times and do not double stack. Once the equipment is in the installation location and ready to be installed, packaging material can be removed. Once the enclosure is unbolted from the wooden pallet, the equipment can be installed using the lifting provision located on the top of the structure. Be careful not to damage the top or bottom enclosure mounting flanges. Refer to Section 4 of this manual for specific installation instructions.

### 2.3 STORAGE

Although well packaged, this equipment is not suitable for storage outdoors. The equipment warranty will not be applicable if there is evidence of outdoor storage. If the equipment is to be stored indoors for any period of time, it should be stored with its protective packaging material in place. Protect the equipment at all times from excessive moisture, construction dirt, corrosive conditions and other contaminants. It is strongly suggested that the package protected equipment be stored in a climate controlled environment of -20° to 85° with a relative humidity of 80% or less. Do not, under any circumstances, stack other equipment on top of a transfer switch equipment enclosure, whether packaged or not.

## SECTION 3: EQUIPMENT DESCRIPTION

### 3.1 GENERAL

This Cutler-Hammer transfer switch equipment is available in one configuration:

- Automatic Transfer Switch

Refer to Section 1 for a discussion of all types. Each transfer switch is usually supplied in an enclosure, although unmounted sub-assemblies can be supplied for mounting by the customer. The enclosed automatic transfer switch is the only specific type that will be discussed in this section.

The enclosed automatic transfer switch consists of three basic panels interconnected through connector plugs and mounted in an enclosure:

- Power Panel
- Voltage Selection Panel
- Logic Panel
  - IQ Transfer

The components comprising the three panels are installed in accordance with the specific requirements of the circuit being controlled. Each transfer switch is, therefore, tailor-made to a specific application.

### 3.2 POWER PANEL

The power panel consists of a means for making load, power, and neutral connections. The main contacts and the transfer mechanism are all on one steel frame (Figures 3-1). The actual power connections are shown in Figure 3-3.

#### 3.2.1 MAIN CONTACTS

The main contacts connect and disconnect the load to and from the different power sources. High withstand insulated case switches are the main contacts for the Normal and Emergency power sources in standard, unmodified automatic transfer switches. Optional integral thermal and short circuit protection in either or both switching devices is available (Figure 3-2 and Section 3.6). These continuous duty devices are rated for all classes of loads. In addition, they have high dielectric strength, heavy-duty switching and withstand capabilities, and high interrupting capacity.

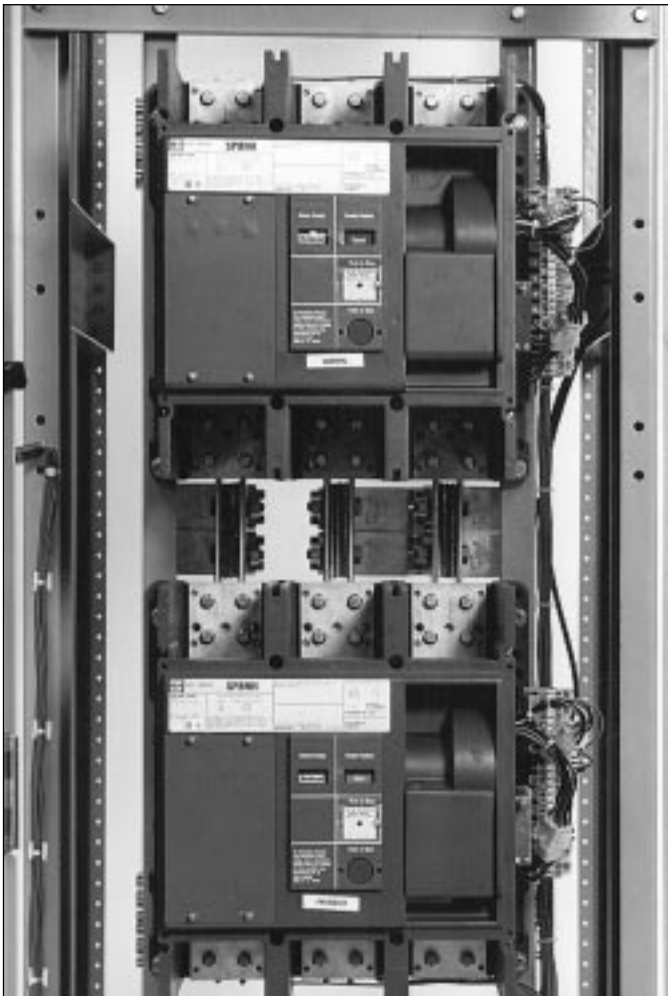

Figure 3-1 Typical Power Panel



Figure 3-2 Insulated Case Circuit Breaker

### 3.2.2 DRAWOUT INTERLOCKS

The standard closed transition ATS is not provided with a mechanical interlock. All bypass switching devices are mechanically interlocked to the drawout mechanism to ensure that the switching device is always open when connecting or disconnecting it from the line and load stabs when in the bypass mode.



### CAUTION

**LIFTING THE PADLOCK LATCH WHILE ATTEMPTING TO RACK THE SWITCH IN OR OUT WHEN THE SWITCH CONTACTS ARE CLOSED WILL CAUSE THE SWITCH TO OPEN.**

The switching device will close only in the DISCONNECT, TEST, and CONNECT positions. The switching device will not close in the WITHDRAW position.

### 3.2.3 TRANSFER MECHANISM

The transfer switch uses Cutler-Hammer SPB-type insulated case circuit breakers and insulated case switches with a stored-energy mechanism (Figure 3-2). An electrical operator automatically recharges the mechanism after the switching device has been closed, and an indicator on the switch shows whether it is in the OPEN or CLOSED position and the status of the stored energy mechanism.

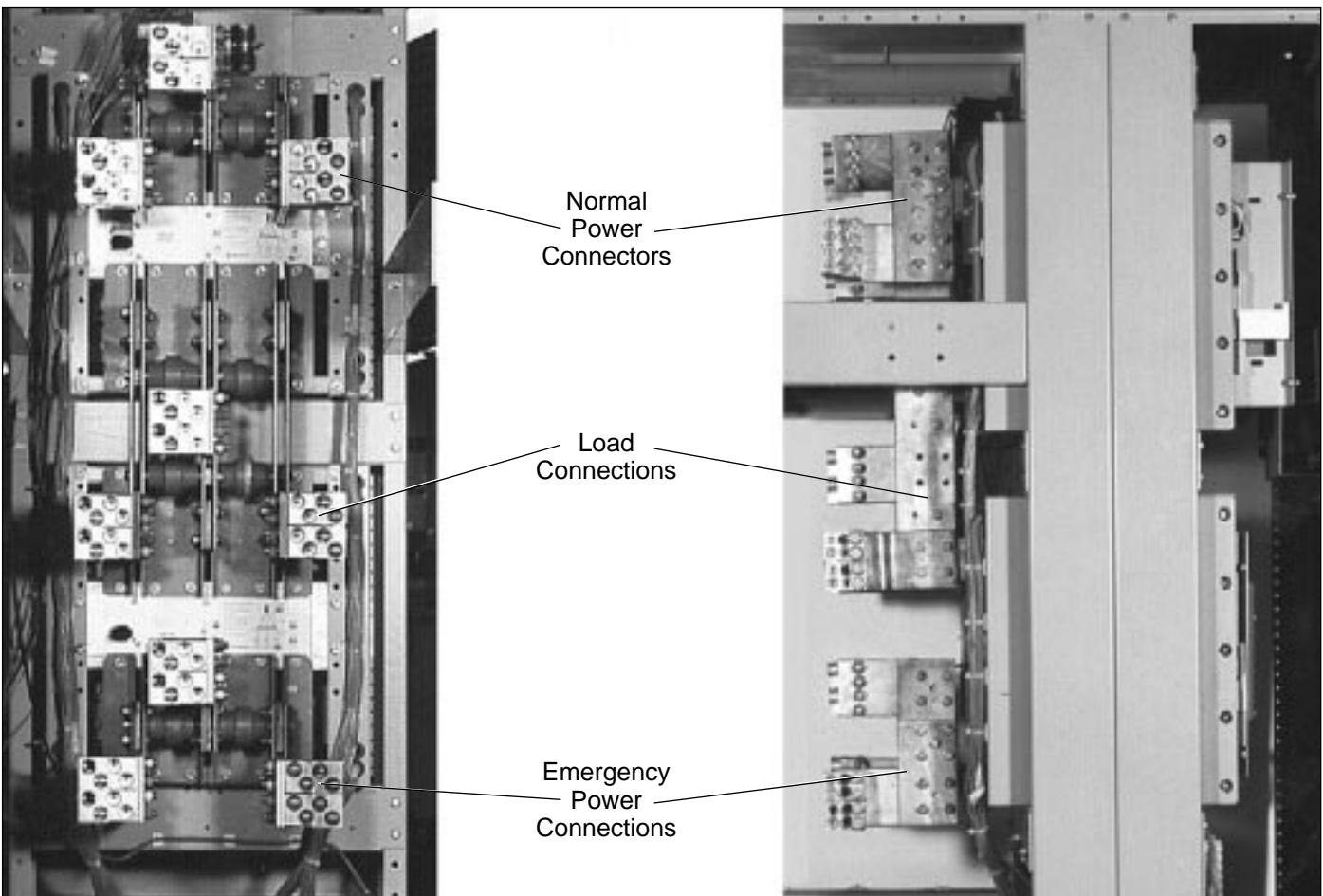

Figure 3-3 Side View and Rear View of Power Panel

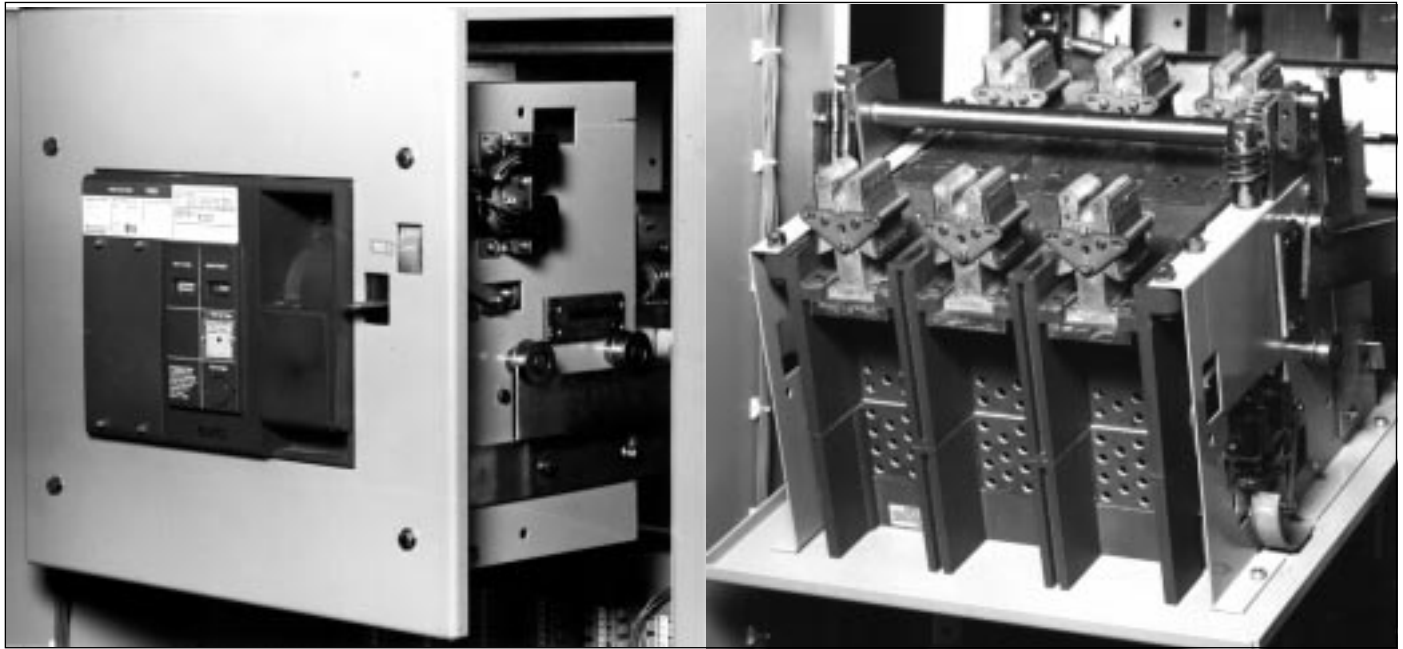

Figure 3-4 Drawout Mechanism

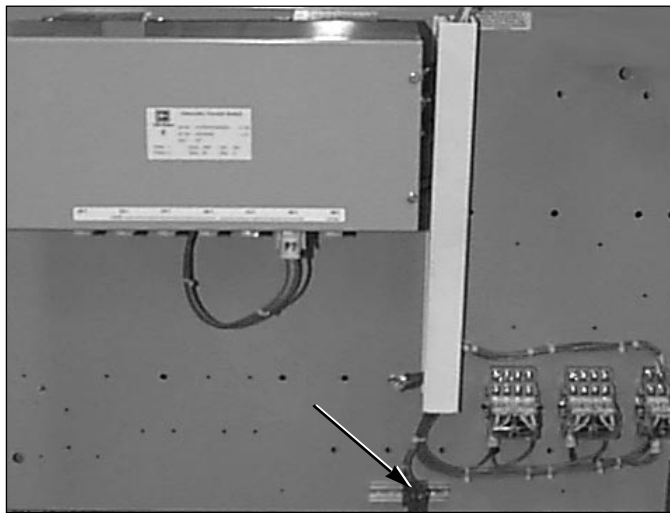

Figure 3-5 Voltage Selection Panel (Engine Start Contacts Identified)

The switching device is closed by energizing a solenoid that releases the spring mechanism. A shunt trip will open the switching device if energized.

### 3.2.4. DRAWOUT MECHANISM

The drawout mechanism is described in detail in Section 6 (Figure 3-4).

### 3.3 VOLTAGE SELECTION PANEL

The voltage selection panel is a multi-tap-enclosed transformer mounted in the enclosure (Figure 3-5). Seven front-accessible voltage taps from 208 to 600 volts AC satisfy most required application voltages. A quick change capability from one voltage to another is provided by a small disconnect plug.

### 3.4 LOGIC PANEL

The logic panel provides the intelligence and supervisory circuits which constantly monitor the condition of both normal and emergency power sources thus providing the required intelligence for transfer operations (Figure 3-6). Detailed information is presented in a separate document:

- IQ Transfer Instruction Book

### 3.5 NEUTRALS

All 2-pole and 3-pole transfer switches are equipped with 100-percent-rated neutral connections (Figure 3-7). Different lug configurations are available, Option 21A.



Figure 3-6 IQ Transfer

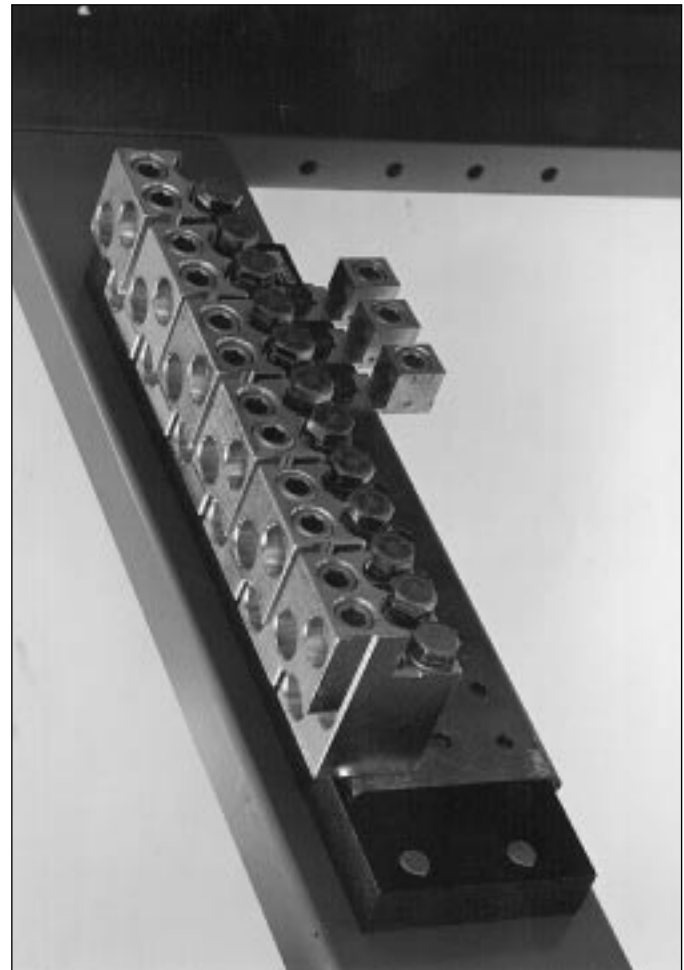

Figure 3-7 Neutral Connection

### 3.6 OPTIONS (NON-LOGIC PANEL)

Switch options, which are not part of the logic scheme, are available to meet a variety of other application requirements. Options are numbered with an associated description. More detailed selections that must be made within a specific option are lettered. For available options associated with the logic scheme, refer to the specific logic document associated with the type of logic selected.

**NOTICE**

**Options are Underwriters Laboratories, Inc. listed, except as noted, when supplied on UL Listed Switches. If an option is selected that is Not UL Listed, the switch Will Not Have A UL Label.**

**NOTICE**

**Not all options are available for all transfer switch configurations. If in doubt, check Price List 29-920 for the availability of options for a specific transfer switch design. The option numbers used here correspond to the numbers used in the price list.**

#### 14. Relay Auxiliary Contact

The Normal power source relay is energized only when the switch is in the Normal position and Normal power is present. The Emergency power source relay is energized whenever the Emergency power source is present.

- C. Normal Power Source: Provides 2 NO and 2 NC contacts
- D. Emergency Power Source: Provides 2 NO and 2 NC contacts

### 16. Power Switch with Integral Overcurrent Protection

Use of this option can, in many cases, eliminate the need for separate upstream overcurrent/short circuit protection, thus enabling code requirements to be met with a device that takes up less space and requires less wiring.

- B. Both Normal and Emergency Sides
- E. Emergency side only
- N. Normal side only

### 17C. High Withstand Rating

Increases withstand rating from 65 kA to 100 kA at 480 volts

### 18. IQ Metering

- I. IQ Generator - Normal Only
- J. IQ Generator - Emergency Only
- K. IQ Generator - Both N&E (Selectable)
- O. IQ Analyzer - Normal Only
- P. IQ Analyzer - Emergency Only
- Q. IQ Analyzer - Both N&E (Selectable)
- R. DP-4000 - Normal Only
- S. DP-4000 - Emergency Only
- T. DP-4000 - Both N&E (Selectable)

### 20A. Rear Bus Connections

Solderless lugs are furnished as standard on all enclosed and open units. Rear bus connections are only available on open units.

### 21A. Non-Standard Terminals

(Refer to Cutler-Hammer)

### 24. Battery Charger

The trickle charge DC output is 12 or 24 volts. Units are supplied in a separate wall mounted enclosure, and have an automatic high-low charge rate.

- C. 12 volt
- D. 24 volt

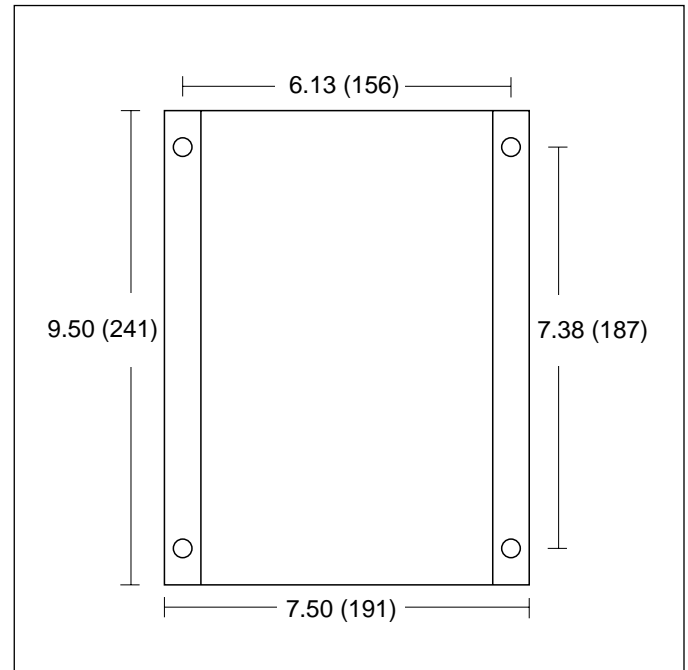

Figure 3-8 Charger Mounting Dimensions in Inches (mm)

When supplied, the battery charger is provided in a separate wall mounted enclosure (Figure 3-8). Separate instructions and wiring information are provided with the charger for installation purposes.

## NOTICE

**A separate 120 VAC control power supply is required for the battery charger input. No connections between the transfer switch and battery charger should be made.**

### 34. Extender Cable

An extender cable provides a means for extending the distance between the power switching panel and the logic panel. This allows for remote mounting of the logic panel.

- A. 48 inch (1.2 m)
- B. 72 inch (1.8 m)
- C. 96 inch (2.4 m)
- D. 120 inch (3.0 m)
- E. 144 inch (3.7 m)

Special lengths are available. Contact Cutler-Hammer.

**Service Entrance**

- A. Provides transfer switch as suitable for service equipment rating - A key operated selector switch permits external, power operated service disconnection with external pilot light for disconnect indication, also includes Option 16.
- B. Same as A except includes ground fault protection.

**41. Space Heater with Thermostat**

- A. 100 Watts
- B. 200 Watts
- C. 400 Watts

**42. Seismic Withstand Capability**

Provides transfer switch with seismic capability exceeding the worst case Zone 4 required levels per both the **Uniform Building Code** and the **California Building Code**.

**3.7 ENCLOSURE**

The rugged steel switch enclosure is supplied with three door hinges, regardless of enclosure size, to insure proper support of the door and door mounted devices (Figures 3-9, 4-1 and 4-2). The hinges have removable hinge pins to facilitate door removal. The doors are supplied as standard with a key lockable handle. Cable entry holes are the customer's responsibility.

The door is used to mount a variety of lights, switches and pushbuttons, depending upon the options required for a particular switch. All switch doors are supplied with a heavy duty plastic accessory panel in place, whether or not external devices are required. When lights, pushbuttons or switches are required, they are normally mounted in the plastic door mounted panel. Models of 2500 amperes and higher have two doors (Figures 4-1 and 4-2).

Transfer switch enclosures and all internal steel mounting plates, such as the power panel mounting plate, go through a pre-treatment cleaning system prior to painting to insure a durable finish.

The standard switch enclosure is NEMA Type 1 for general indoor use (Table 3.1).



Figure 3-9 Typical Switch Enclosure

Table 3.1 Transfer Switch Equipment Enclosures

NEMA Type	Design	Protection
1	Indoor	Enclosed Equipment
3R	Outdoor	Rain, Ice Formation

**3.8 STANDARDS**

Cutler-Hammer transfer switch equipment enclosed in a NEMA 1 enclosure is listed for application by UL, and are certified to meet Canadian Standards by Underwriters Laboratories Inc. (CUL), except for Bypass Isolation units. In addition, Cutler-Hammer Automatic Transfer Switches are listed in File E38116 by Underwriters Laboratories, Inc. under Standard UL 1008. This standard covers requirements for automatic transfer switches intended for use in ordinary locations to provide for lighting and power as follows:

- n emergency systems, in accordance with articles 517 and 700 in the National Electrical Code, ANSI/NFPA 70 and the National Fire Protection Association No. 76A and/or
- b. In stand-by systems, in accordance with article 702 of the National Electrical Code and/or
  - c. In legally required stand-by systems in accordance with article 701 of the National Electrical Code.

Cutler-Hammer Automatic Transfer Switches are available to meet NFPA 110 for emergency and stand-by power systems, and NFPA 99 for health care facilities when ordered with the appropriate options.

Since Cutler-Hammer Automatic Transfer Switches utilize specially designed switches and/or circuit breakers as the main power switching contacts, these devices must also be listed under the additional UL Standards

489 and 1087. Underwriters Laboratories utilize two basic types of listing programs: a) Label service b) Re-examination. UL489 and UL1087 employ a label service listing program which requires an extensive follow-up testing program for listed devices. Standard UL1008 for automatic transfer switches lists devices under the re-examination program which only requires a continual physical re-examination of the components used in the product to insure consistency with the originally submitted device. Follow-up testing is not required by UL1008.

Representative production samples of switches and circuit breakers used in Cutler-Hammer Automatic Transfer Switches are subjected to a complete test program identical to the originally submitted devices on an ongoing periodic basis per UL489 and UL1087. The frequency of such a re-submittal can be as often as every quarter for a low ampere device.

## SECTION 4: INSTALLATION AND WIRING

### 4.1 GENERAL

Transfer switches are factory wired and tested. Installation requires solidly mounting the enclosed unit and connecting power cables and auxiliary pilot circuits. Physical mounting procedures and power cable connections are covered in this section. All other required wiring or electrical connection references are covered in a separate **Customer Wiring Diagrams** packed with the transfer switch. Locate the wiring booklet, review it, and keep it readily available for reference purposes during installation and testing. Once a transfer switch is properly installed and wired, it should be mechanically and electrically checked for proper installation and operation. The procedures for these initial mechanical and electrical checks are outlined in Section 6 of this instruction manual.



### WARNING

**BE CERTAIN THAT THE SOLID STEEL POWER PANEL SHIELD IS PROPERLY INSTALLED BEFORE TRANSFER SWITCH EQUIPMENT IS PUT INTO SERVICE. THE SHIELD PROVIDES PROTECTION FROM DANGEROUS VOLTAGES AT THE LINE AND LOAD TERMINALS WHEN THE EQUIPMENT IS IN OPERATION. FAILURE TO DO SO COULD RESULT IN PERSONAL INJURY OR DEATH.**

### 4.2 MOUNTING LOCATION

Choose a location that offers a flat, rigid mounting surface capable of supporting the weight of the enclosed transfer switch equipment (Figure 4-1 or 4-2). Avoid locations that are moist, hot, or dusty. Enclosure designs are, however, available for special environments. If there are any doubts as to location suitability, discuss it with your Cutler-Hammer representative.

Check to make certain that there are no pipes, wires, or other hazards in the immediate area that could create a problem. The panels provide ample room for rear cable entry from top, bottom, and sides. At no time should cable be routed to retard the action of relays or cover the logic in a way that restricts adjustments. Maintain proper electrical clearances between live metal parts and grounded metal.

For installation and maintenance purposes, the primary and secondary sources must have an overcurrent protective device upstream of the transfer switch, unless overcurrent protection is integral to the switch.

Dimensions of the transfer switch are an important consideration in determining proper location selection (Figure 4-1 and 4-2).

### 4.3 MOUNTING PROCEDURE



### CAUTION

**SINCE THE ENCLOSED TRANSFER SWITCH MUST BE LIFTED INTO PLACE FOR MOUNTING, BE CERTAIN THAT ADEQUATE RESOURCES ARE AVAILABLE FOR LIFTING TO AVOID PERSONNEL INJURIES OR EQUIPMENT DAMAGE.**

Cable entry holes are not part of the enclosure when shipped from the factory and must be provided in the field, either before or after mounting the enclosure. Proceed with the following four steps:

- Step 1:** Carefully uncrate the transfer switch. If damage is visible, please contact your local Cutler-Hammer sales representative or the factory at 800-354-2070.
- Step 2:** Open the door and visually verify that there are no broken or damaged components or evidence of distorted metal or loose wires as a result of rough handling.
- Step 3:** A label on the baseplate provides specifications for your transfer switch. Verify that these specifications comply with your requirements.
- Step 4:** Remove any braces or packing used to protect the transfer switch or internal components during shipping.



### CAUTION

**EXTREME CARE SHOULD BE TAKEN TO PROTECT THE TRANSFER SWITCH FROM DRILL CHIPS, FILINGS, AND OTHER CONTAMINANTS WHEN MAKING THE CABLE ENTRY HOLES AND MOUNTING THE ENCLOSURE TO PREVENT COMPONENT DAMAGE OR A FUTURE MALFUNCTION.**

With the enclosed transfer switch equipment unpacked and ready for mounting, proceed with the following steps:

- Step 1:** The transfer switch enclosure door is hinge mounted with removable hinge pins. To simplify the mounting procedure, carefully remove the

**AUTOMATIC, NON-AUTOMATIC AND  
MANUAL TRANSFER SWITCHES**

Enclosures meet all current applicable NEMA and UL standards for conduit entry, cable bending, gutter space and shielding of live components.

**NEMA 1 Enclosures**

NEMA 1 Transfer Switches are supplied with a front door only. They can be mounted in a corner or against a wall. Access to cable space can be via either side, bottom, top, or the rear.

**NEMA 3R Enclosures**

Additional 2" (5.1cm) clearance on each side of enclosure for hooded vent patterns.

Requires appropriate rear-end clearance based on 26-34" (66-86cm) door (800-2000A) or 31" (61cm) door (2500-4000A).

NEMA 3R Transfer Switches are supplied with front & rear doors. They can be mounted against a wall (allowing for hooded vent pattern clearance), but not in a corner. Access to cable space is via rear only.

NOTE: When open switch is mounted in customer enclosure, a vent pattern similar to that used on a Cutler-Hammer enclosure must be utilized.

Transfer Switch Rating		Dimensions & Conduit Opening				Wt. lb (kg)
		A in (cm)	B in (cm)	C in (cm)	D in (cm)	
3 Pole 800-1200 <sup>①</sup>	Drawout	28.00 (71.1)	60.00(152.4)	23.50 (59.7)	28.40 (72.1)	1650 (748)
4 Pole 800-1200 <sup>①</sup>	Drawout	34.00 (86.4)	60.00 (152.4)	29.50 (74.9)	28.40 (72.1)	1900 (862)
3 Pole 2500-4000A	Drawout	48.00 (121.9)	72.00 (182.9)	43.25 (109.9)	33.80 (85.9)	2200 (998)
4 Pole 2500-4000A	Drawout	48.00 (121.9)	72.00 (182.9)	43.25 (109.9)	29.60 (75.2)	2400 (1089)

<sup>①</sup> 800-1200A supplied with Option 17C

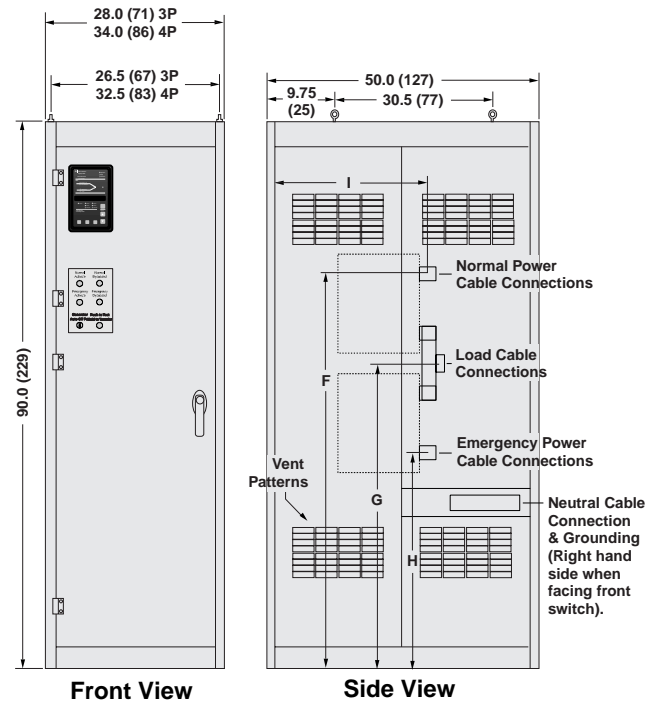

**800-2000 amperes, 3 or 4 Poles  
800-1200 only if Option 17C is selected**

**Note: Additional dimensions  
next page.**

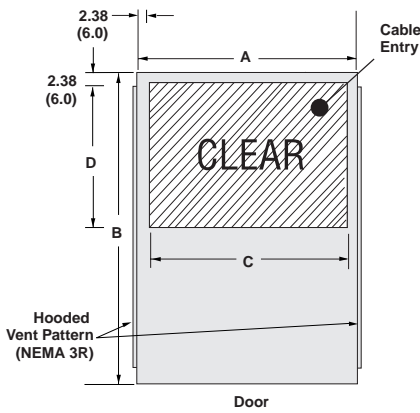

**Top View**

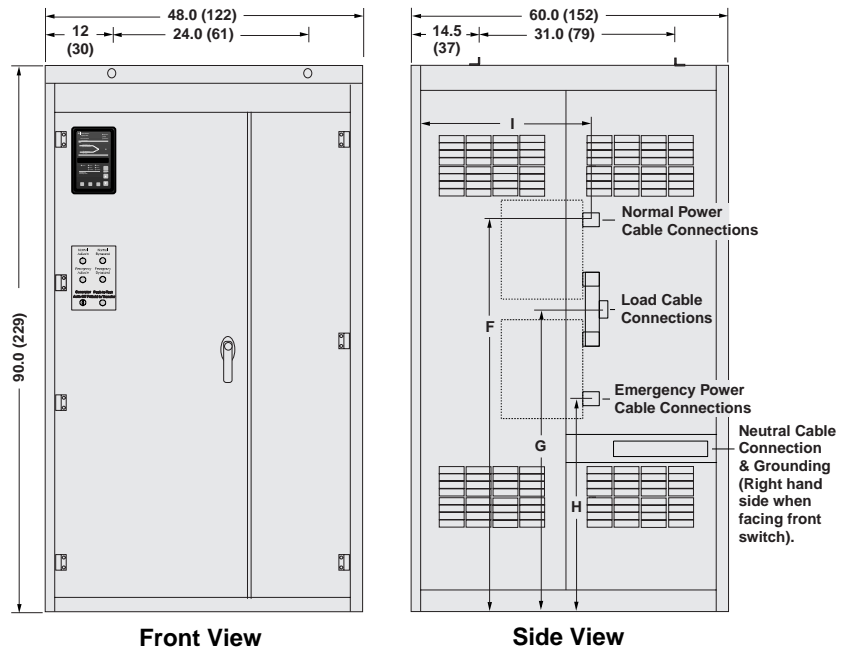

**Front View**

**Side View**

**Dimensions are in inches  
(centimeters).**

**2500-4000 amperes, 3 Poles  
2500-3000 amperes, 4 Poles**

Figure 4-1 Enclosed Drawout Transfer Switch (NEMA 1 Enclosure)

**AUTOMATIC, NON-AUTOMATIC AND MANUAL TRANSFER SWITCHES**

Enclosures meet all current applicable NEMA and UL standards for conduit entry, cable bending, gutter space and shielding of live components.

**NEMA 1 Enclosures**

NEMA 1 Bypass Isolation Transfer Switches are supplied with a front door only. They can be mounted in a corner or against a wall. Access to cable space can be via either side, bottom, top, or the rear.

Transfer Switch Specifications	Dimensions & Conduit Opening					CC Cable Space Depth	Wt. lb (kg)
	A in (cm)	B in (cm)	C in (cm)	D in (cm)	E in (cm)		
3 Pole 800-2000A	56.00 (142.2)	60.00 (152.4)	23.24 (59.0)	30.00 (76.2)	23.24 (59.0)	28.44 (72.2)	3400 (1542)
4 Pole 800-2000A	68.00 (172.7)	60.00 (152.4)	29.24 (74.3)	30.00 (76.2)	29.24 (74.3)	28.44 (72.2)	4000 (1814)
3 Pole 2500-3000A	82.00 (208.3)	60.00 (152.4)	29.24 (74.3)	30.00 (76.2)	43.25 (109.9)	23.84 (60.6)	4500 (2041)
4 Pole 2500-3000A	82.00 (208.3)	60.00 (152.4)	29.24 (74.3)	30.00 (76.2)	43.25 (109.9)	23.84 (60.6)	4900 (2223)

Dimensions are in inches (centimeters).

Transfer Switch Rating		Dimensions ①			
		F in (cm)	G in (cm)	H in (cm)	I in (cm)
2000A	Drawout	79.92 (203.0)	58.70 (149.1)	42.64 (108.3)	34.91 (88.7)
3000A	Drawout	75.28 (191.2)	49.14 (124.8)	23.00 (58.4)	44.26 (112.4)
4000A	Drawout	77.52 (196.9)	52.71 (133.9)	27.90 (70.9)	48.00 (121.9)
800-2000A	Bypass Isolation	53.00 (134.6)	34.00 (86.4)	16.00 (40.6)	34.00 (86.4)
2500-3000A	Bypass Isolation	75.28 (191.2)	57.28 (145.5)	23.00 (58.4)	42.00 (106.7)

① Applicable to this page and previous page

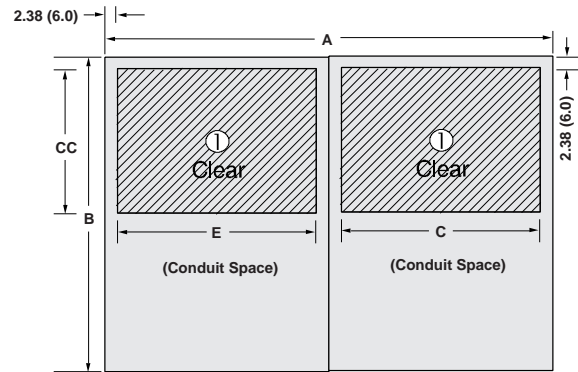

Top View

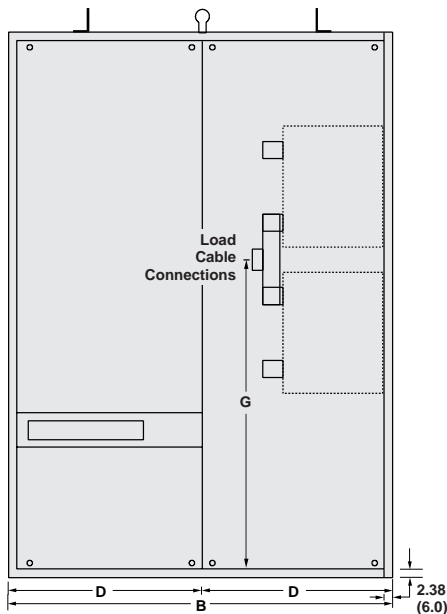

Left Side View

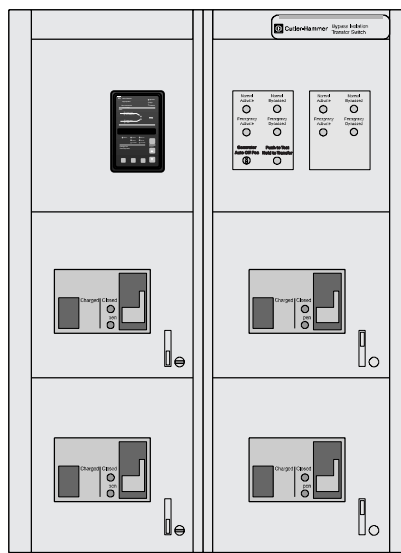

Front View

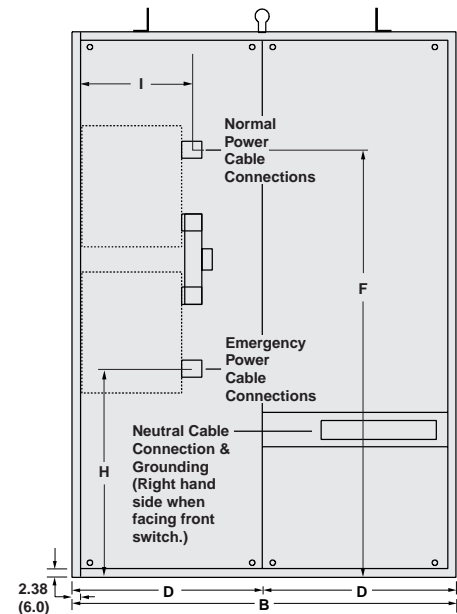

Right Side View

Figure 4-2 Enclosed Bypass Isolation Transfer Switch (NEMA 1 Enclosure)

door and set it aside in a safe place until mounting is complete.

- Step 2:** Gently maneuver the switch into its location using the four lift brackets.
- Step 3:** Bolt the enclosure to the base. Use separate cleats (Option 42 only) if Seismic UBC Zone 4 certification is desired (Figure 4-5), and secure with 1/2-13 UNC Grade 5 hex bolts.
- Step 4:** Tighten bolts to 50 ft-lbs (68 Nm).
- Step 5:** Double check to ensure that all packing and shipping material has been removed.

#### 4.4 POWER CABLE CONNECTIONS



### WARNING

**POWER CONDUCTORS MAY HAVE VOLTAGE PRESENT THAT CAN CAUSE SEVERE PERSONAL INJURY OR DEATH. DE-ENERGIZE ALL POWER OR CONTROL CIRCUIT CONDUCTORS TO BE CONNECTED TO THE TRANSFER SWITCH EQUIPMENT BEFORE BEGINNING TO WORK WITH THE CONDUCTORS AND/OR TERMINATING THEM TO THE EQUIPMENT.**



### CAUTION

**USE OF CABLE LUGS NOT DESIGNED FOR THE TRANSFER SWITCH MAY CAUSE HEATING PROBLEMS. BREAKER LUGS ONLY MOUNT TO THE BREAKER, WHILE TRANSFER SWITCH LUGS MOUNT TO BOTH THE BREAKER AND THE BUS BAR BEHIND THE BREAKER. FOR INSTALLATION INSTRUCTIONS, REFER TO THE INSTRUCTION LEAFLET SUPPLIED FOR THE SPECIFIC LUGS.**



### CAUTION

**TO HELP PREVENT COMPONENT DAMAGE OR FUTURE MALFUNCTIONS, USE EXTREME CARE TO KEEP CONTAMINANTS OUT OF THE TRANSFER SWITCH EQUIPMENT WHEN MAKING POWER CABLE CONNECTIONS.**

Proceed with the following steps:

- Step 1:** Verify that the line and load cables comply with applicable electrical codes.
- Step 2:** Verify that transfer switch rated current and voltage (see identification plate on the intelligence panel of transfer switch) agree with system current and voltage.
- Step 3:** After the transfer switch is mounted, provide conduit or cable openings as required. Ensure that no metal filings contaminate the transfer switch components.
- Step 4:** Test all power cables before connecting to the unit to insure that conductors or cable insulation have not been damaged while being pulled into position.
- Step 5:** Carefully strip insulation from the power cables. Avoid nicking or ringing of the conductor strands. Prepare the stripped conductor termination end by cleaning it with a wire brush. If aluminum conductors are used, apply an appropriate joint compound to the clean conductor surface area. Refer to Figure 4-3 for approximate locations of power connections.

Power cables are to be connected to solderless screw type lugs located on the transfer switch switching devices. Refer to the separate **Customer Wiring Diagrams** supplied with the transfer switch equipment for power termination. Verify that the lugs supplied will accommodate the power cables being used. Also verify that the cables comply with local electrical codes. Standard transfer switch equipment, as supplied from the factory, will accommodate the wire sizes shown in Table 4.1.



### CAUTION

**IMPROPER POWER CABLE CONNECTIONS CAN CAUSE EXCESSIVE HEAT AND SUBSEQUENT EQUIPMENT FAILURE.**

- Step 6:** Tighten cable lugs to the torque identified on the label affixed to the unit immediately adjacent to the lugs.
- Step 7:** Make necessary connections of options using wiring diagrams supplied with the unit.
- Step 8:** Connect engine start wires to the red terminal blocks marked 51 and 52.

#### 4.5 VOLTAGE SELECTION ADJUSTMENT

Certain devices, such as the Voltage Selection Panel, sensing relays and timers, need to be set and/or calibrated prior to placing the transfer switch equipment into service. Adjustments for logic devices are described in the separate instructional document dedicated to the specific logic being used. Voltage selection adjustments are described here.



### CAUTION

**BE SURE THAT THE CORRECT VOLTAGE IS SELECTED TO MATCH THE SYSTEM VOLTAGE. AN IMPROPER SELECTION AND/OR CONNECTION COULD RESULT IN EQUIPMENT DAMAGE.**

Table 4.1 Wire Size for Power Cable Connections

Switch Rating (Amps)	Cables Per Phase	Range Wiring Size
800-2000	8	4/0-500 MCM
2500-3000	12	4/0-500 MCM
4000	16	4/0-500 MCM

#### 4.6 MOUNTING SWITCHING DEVICE IN THE DRAW OUT MECHANISM

When mounting the switching device in the drawout mechanism, ensure that the extension rails are pulled out to full extension, and that the tape has been removed from the secondary control block contact openings (Figures 4-4 and 4-6).

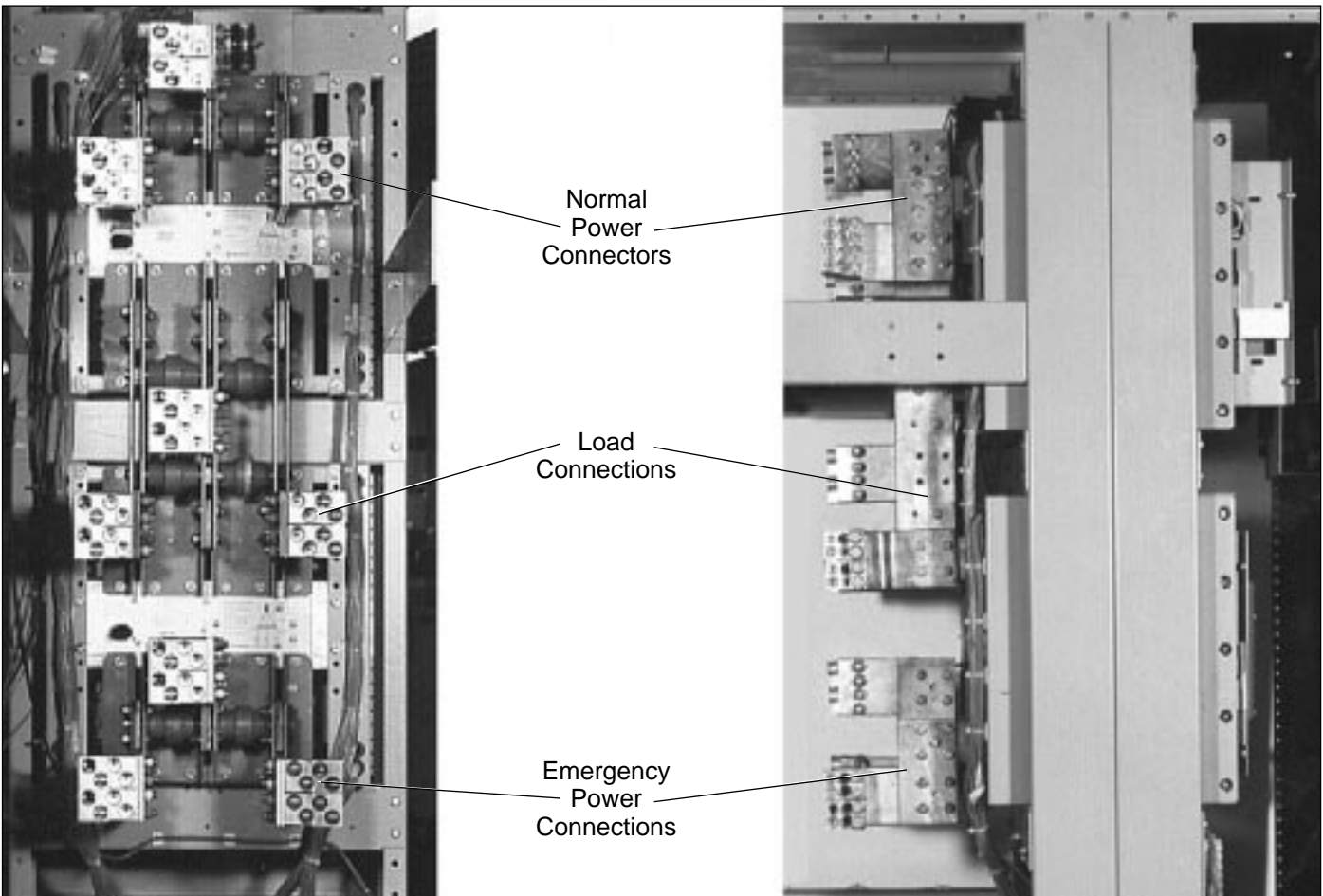

Figure 4-3 Side View and Rear View of Power Panel

## Seismic Tested and Approved Product Mounting Instructions

In all cases, the unit must be mounted using all provided mounting holes. In addition, the floor-mounted units must use the provided mounting cleats. These cleats must be placed between the head of the bolt and the sheet metal enclosure. It is also necessary to use 0.5-13UNC Grade 5 or better hex head bolts. These bolts are to be torqued to 50 ft. lbs. (68 Nm) depending on the unit. The table below is a summary of the torque values used for each unit.

Switch Type	Amp Rating	Mounting Bolt Torque
CTVSSP	600-4000A	50 ft. lbs.(68 Nm)

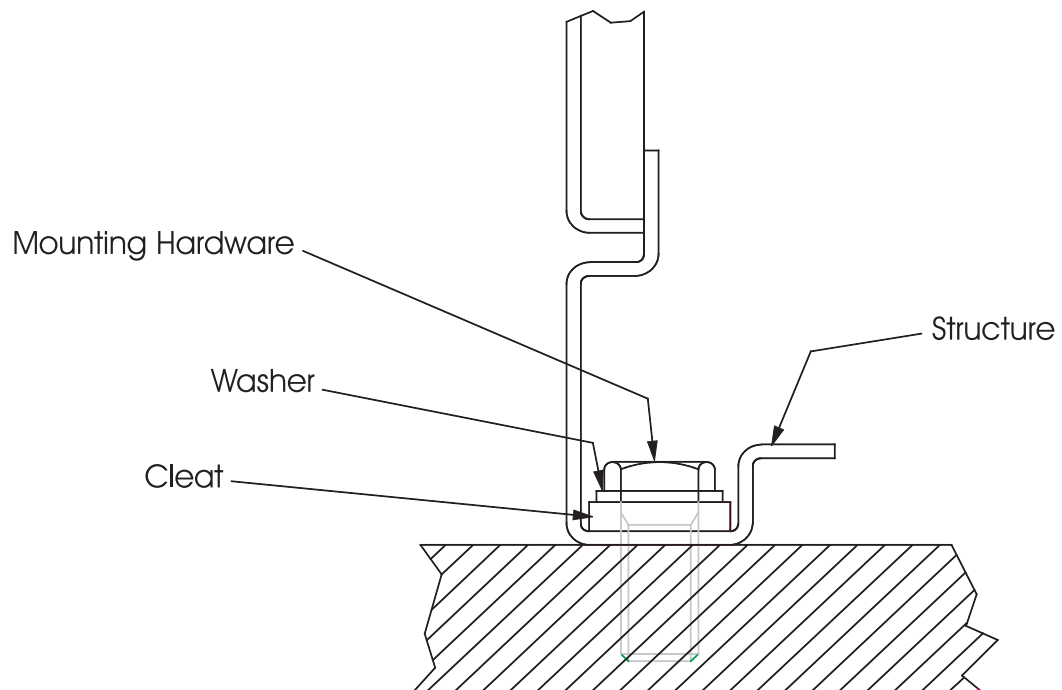

Figure 4-5 Seismic Tested and Approved Product Mounting Instructions

Use a wide strap attached to an overhead crane for lifting the switch. Tilt the switching device forward and slip the strap underneath, placing it between the two draw-out wheels on each side. Steady the sides of the switching device as the crane lifts it to ensure that it does not slip off the strap. Lower all four wheels onto the top of the switching device extension rails (Figure 4-7). The front wheels on the switching device will fit into a depression at the front of the rails, and it will rest there securely.

Remove the strap. It will slide out between the switching device and the extension rails. A molded escutcheon on the switching device cell door is for mounting the label for the indexing lever. This label indicates the position of the switch. With the cell door in place attach the escutcheon to the outside of the enclosure door.

Place the switching device in the TEST position. Peel the backing off the label that indicates the position of the switching device and place it on the escutcheon so that the test position indicator lines up correctly with the indexing lever.

**4.7 WIRING**



**CAUTION**

**POWER CONDUCTORS AND CONTROL WIRING MAY HAVE VOLTAGE PRESENT THAT CAN CAUSE SEVERE PERSONAL INJURY OR DEATH. DE-ENERGIZE ALL POWER OR CONTROL CIRCUIT CONDUCTORS BEFORE BEGINNING TO PERFORM ANY WIRING ACTIVITY TO OR WITHIN THE TRANSFER SWITCH EQUIPMENT.**

Power sources, load conductors and control wiring should be connected to locations as indicated in the **Customer Wiring Diagrams** supplied with the transfer switch equipment.

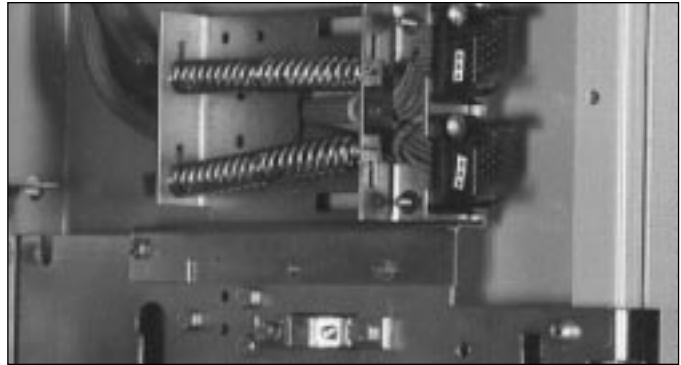

Figure 4-6 Secondary Control Block Contact Opening

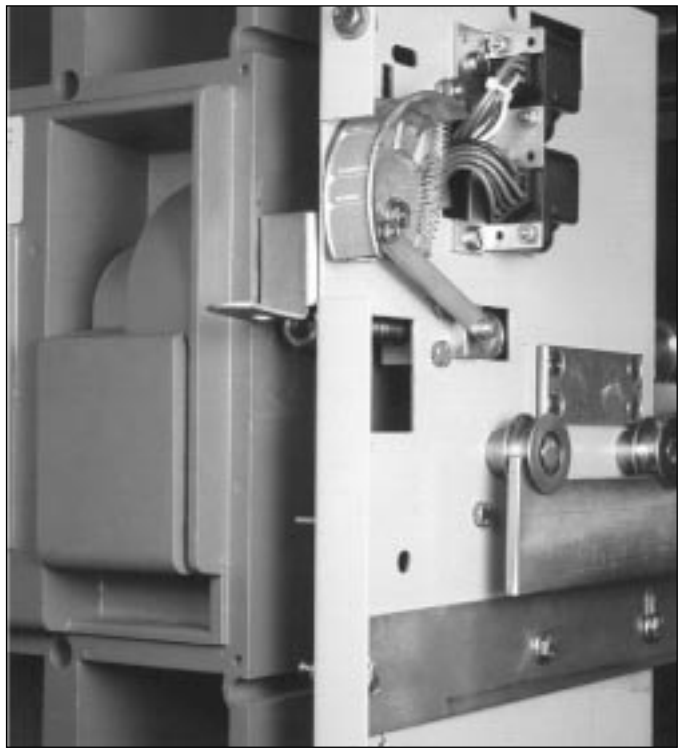

Figure 4-7 Correct Placement

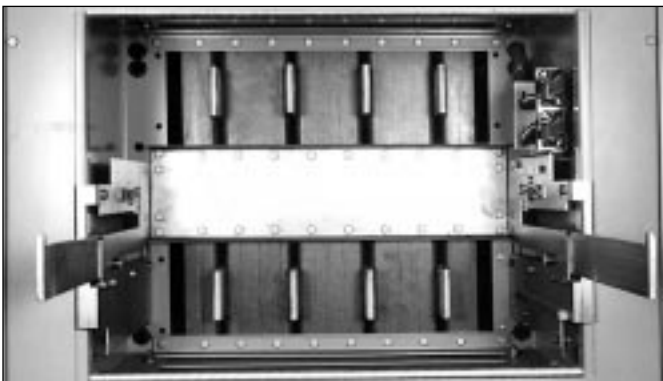

Figure 4-4 Drawout Stationary

#### 4.7.1 ENGINE START CONNECTION

The engine control contact connections are located on the lower right of the transformer panel of the ATS (Figure 3-5). The engine control contact connections of bypass isolation units are located in the rear of the enclosure (51A, 52A). NOTE: Prior to making the engine start connection to the switch on bypass isolation units, set the engine generator controls selector switch in the OFF position to prevent an unwanted engine start. Connect the engine start wires to the red terminal blocks marked 51 and 52 or 51A and 52A for bypass isolation

units. A contact closes between these terminal blocks when an engine start signal is provided by the ATS logic.

#### 4.7.2 ALARM CONTACTS

Closed transition automatic transfer switches are provided with 4 N.O. and 4 N.C. contacts (KA) for remote alarming. These contacts are energized when the TDUP (Time Delay Utility Parallel) times out (preset by user). The TDUP timer starts timing when both sources are paralleled. Refer to the IQ Transfer instruction book for additional alarms.

## SECTION 5: OPERATION

### 5.1 GENERAL



### WARNING

**THIS PRODUCT CONTAINS A SPECIAL CONTACT ARRANGEMENT (OVERLAPPING CONTACTS). MIS-USE CAN RESULT IN DEATH, SEVERE PERSONAL INJURY AND/OR PROPERTY DAMAGE.**

A transfer switch provides main contacts to connect and disconnect the load to and from the normal and emergency power sources (Paragraph 3.2.1). A stored-energy type transfer mechanism provides the mechanical motion required to open and close the main contacts (Paragraph 3.2.4 and Figure 3-2).

Each switch can be manually operated. Before a switching device can be closed, the stored energy mechanism must be charged by pumping the handle (Figure 5-1).

A single switching device can be manually closed by following the instructions detailed in Figure 5-2. An indicator window shows whether the switch is open or closed.

### NOTICE

**If a transfer switch with any type of electrical operating capabilities is to be operated manually utilizing the manual operating handle, it is strongly recommended that the transfer control circuit first be isolated. This is accomplished by disconnecting the**



Figure 5-1 Pumping Handle Charges Stored Energy Mechanism

**logic panel. In the case of the automatic transfer switch design, any attempt to operate the manual handle without first isolating the control circuit causes an automatic transfer.**

### 5.2 AUTOMATIC TRANSFER SWITCH

The operating sequence of a closed transition automatic transfer switch is dictated by the switch's standard features and selected options. Operation of an automatic transfer switch during normal power source failure, normal power source restoration and performing tests will be described here with only standard options included on the switch. Additional options, as described in Section 3 or in separate instruction documents, can change sequences and timing depending upon the options selected. Become familiar with any additional options selected and their effect on the normal operation of an automatic transfer switch.

#### Normal Power Source Failure

Standard normal power source failure is defined as a reduction or loss of voltage. If this occurs, the sequence of operation is as follows:

- Failure of the normal power source is detected by the logic.
- When the intelligence circuit detects a failure, the normal relay drops out, opening certain contacts while closing others. One of the contacts starts the engine-driven generator.
- When the emergency power source voltage reaches its operation rating, an emergency relay closes, starting the transfer operation. This operating sequence opens the normal switching device and closes the emergency switching device.
- The load is now transferred to emergency power source.

#### Normal Power Source Restoration

A return to the normal power source begins when the voltage in all phases of a 3-phase sensing unit or voltage in a single phase sensing unit is restored to a preset value.

- At the preset pickup voltage, the logic causes the normal relay to pickup.

- The normal relay closes certain contacts while opening others. This starts the return to the normal power source and normal transfer switch operation.
- During this sequence, the normal power source switch is closed and the emergency power source switch is opened. This completes the make before break transfer.
- Simultaneously, the normal relay initiates the shut down of the engine driven generator.
- Transfer of the load back to the normal power source is now complete.

**Test Mode**

A test begins when either the “TEST” button is used or when the plant exerciser (if available) initiates a test.

- The engine start contact is closed signaling the generator to start.
- When the emergency power source voltage reaches its operating range and the intelligence determines the sources are in phase, the transfer begins. This operating sequence closes the emergency switching device then opens the normal switching device.



<div style="border: 1px solid black; padding: 5px; text-align: center;">  <b>WARNING</b> </div> <div style="border: 1px solid black; padding: 10px; text-align: center; margin-top: 10px;"> <p><b>OVERLAPPING CONTACTS</b> Alternate and Normal Sources must be Synchronized</p> </div> <p style="font-size: small; margin-top: 5px;">7805C60H02</p> <p><b>THIS PRODUCT CONTAINS A SPECIAL CONTACT ARRANGEMENT (OVERLAPPING CONTACTS). MISUSE CAN RESULT IN DEATH, SEVERE PERSONAL INJURY OR PROPERTY DAMAGE.</b></p> <p><b>(THIS LABEL IS APPLIED TO THE DEAD FRONT COVER.)</b></p> <div style="border: 1px solid black; padding: 5px; margin-top: 10px; display: flex; align-items: center;"> <div style="font-size: x-small; padding: 2px;">Do Not Use Without Reading Manual Operating Instructions</div> <div style="margin: 0 10px;">●</div> <div style="font-size: x-small; padding: 2px;"><b>MANUAL CLOSE BUTTON</b></div> </div> <p style="margin-top: 10px;"><b>FOLLOW THE INSTRUCTIONS OUTLINED IN THE NEXT WARNING LABEL.</b></p> <p><b>(THIS LABEL IS APPLIED TO THE COVER OF THE MANUAL CLOSE BUTTON ON EACH SWITCHING DEVICE.)</b></p>	<div style="border: 1px solid black; padding: 5px; text-align: center;">  <b>WARNING</b> </div> <div style="border: 1px solid black; padding: 10px; text-align: center; margin-top: 10px;"> <p><b>Attempting to close both switching devices simultaneously can cause severe injury or death.</b></p> <p><b>Follow Manual Operation Instructions Below</b></p> </div> <div style="border: 1px solid black; padding: 10px; margin-top: 10px;"> <p style="text-align: center;"><u><b>Manual Operation Instructions</b></u></p> <ol style="list-style-type: none"> <li>1. Disconnect Logic Connectors</li> <li>2. Open both switching devices</li> <li>3. Verify “OPEN” flags</li> <li>4. Verify source availability</li> <li>5. Close switching device on available source by inserting a small tool in center of “Manual Close Button” label on switching device.</li> </ol> </div> <p style="font-size: x-small; margin-top: 5px;">7805C60H01</p> <p><b>THESE INSTRUCTIONS ONLY PERTAIN TO MANUALLY CLOSING A SINGLE SWITCHING DEVICE. ATTEMPTING TO CLOSE BOTH SWITCHING DEVICES CAN CAUSE SEVERE INJURY OR DEATH.</b></p> <p><b>(THIS LABEL IS APPLIED TO THE DEAD FRONT COVER.)</b></p>
---	--

Figure 5-2 Switching Device Closing Precautions

## SECTION 6: DRAWOUT MECHANISM

### 6.1 DRAWOUT INTERLOCK

The transfer switch is mechanically interlocked to the drawout mechanism to ensure that the switching device is always open when connecting or disconnecting it from the line and load stabs.



#### CAUTION

**LIFTING THE PADLOCK LATCH WHILE ATTEMPTING TO RACK IN OR OUT THE SWITCHING DEVICE WHEN THE SWITCH CONTACTS ARE CLOSED WILL RESULT IN THE SWITCHING DEVICE OPENING. THIS WILL RESULT IN A LOSS OF POWER TO THE LOAD.**

The socket wrench must be removed and the drawout mechanism in an operational position for the switching device to operate.

The switching device will close in the DISCONNECTED, TEST, and CONNECTED positions. POWER WILL BE DELIVERED FROM A POWER SOURCE TO THE LOAD ONLY WHEN THE SWITCHING DEVICE IS IN THE CONNECTED POSITION. The switching device will not close in the WITHDRAWN position.

### 6.2 SWITCH POSITION

The drawout mechanism has four positions. They are achieved by lifting the padlock latch and inserting a 3/4-inch socket wrench (Figure 6-1). Clockwise motion



Figure 6-1 Drawout with Socket Wrench

moves the switch towards the CONNECTED position. Counterclockwise will move the switch towards the WITHDRAWN position.

#### CONNECTED

The switch is fully connected to the primary stabs and secondary contacts.

#### NOTICE

**With both switches in this position the transfer switch is fully operational.**

#### TEST

The switch is not connected to the primary stabs, but is connected to the secondary contacts.

#### DISCONNECTED

Both primary stabs and the secondary contacts are disconnected.

#### WITHDRAW

The switch may be removed from the cassette.

### 6.3 ROTATION ON THE DRAWOUT

If the switching device needs to be rotated on the drawout for inspection, the deadfront shield must first be

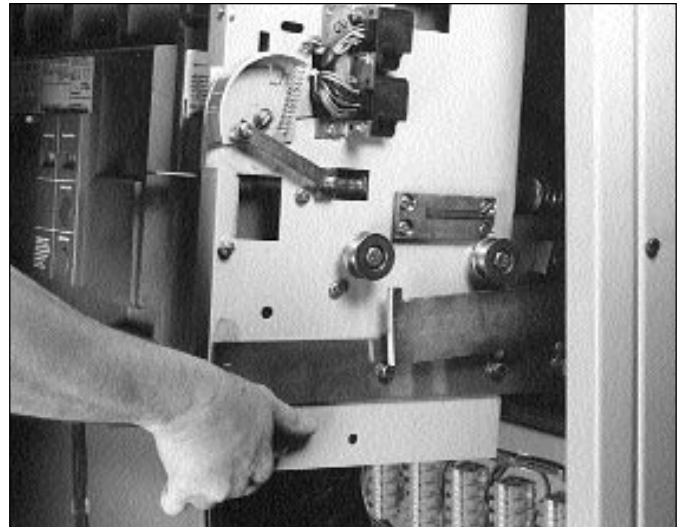

Figure 6-2 Drawout Rotated Out for Inspection

removed. The shield should be removed while the switching device is in the DISCONNECT position, before it is pulled into the WITHDRAWN position. Before beginning the rotation, ensure that the switching device is fully withdrawn, with the front wheels in the depression in the front of the extension rails.

Lift the front of the switch so that the front wheels are off the extension rails, and pull it forward (Figure 6-2) Continue pulling forward on the switching device until the back wheels move into the depression at the end of the extension rails where the front wheels were situated.

As the switching device is turned, be careful of the compartment opening. Do not lift or put pressure on the secondary control contract block assembly on the back of the switch. Turn it by holding the top or bottom (Figure 6-3)



## CAUTION

### NEVER RETURN THE TRANSFER SWITCH TO SERVICE WITHOUT INSTALLING THE DEADFRONT SHIELD.

Return the switching device to the desired position. Replace the deadfront shield when the switch is in the DISCONNECT position.

### 6.4 OPERATIONAL CHECK FOR DRAWOUT MECHANISM

Ensure that the wiring is clear of all obstructions. Rack the switch to the DISCONNECT position. Visually verify that the secondary contacts are apart. Manually charge and close the switching device.

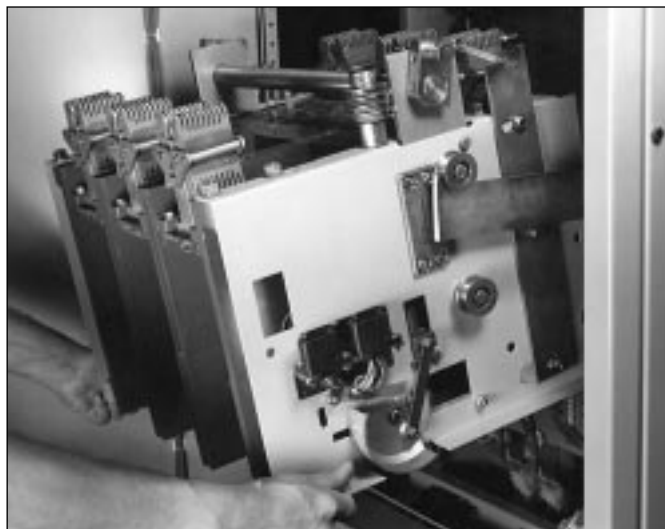

Figure 6-3 Drawout Returned to Upright Position

Rack the switching device to the TEST position. Ensure that the tab falls into the slot of the indicator wheel on the right side of the moveable mechanism. Verify that the switching device opens when the padlock is raised.

Visually verify that the secondary contacts are connected. Check for electrical continuity by energizing the control circuit and operating switching device.

Rack the switching device to the CONNECT position. Visually verify that the secondary contacts remain connected.

Rack the switching device to the DISCONNECT position. Visually verify that the secondary contacts are apart.

## SECTION 7: OPERATION OF BYPASS ISOLATION TRANSFER SWITCH

### 7.1 OPERATOR PANEL

The design of this transfer switch allows quick removal of the different switching devices for inspection or maintenance, or if required, quick replacement.

The bypass isolation switch has two operator panels with switches and lights (Figure 7-1). The following descriptions are for those features that are standard with the bypass isolation switch. Additional features are described in the options section.

The left control panel has the following standard features:

1. Light to indicate if the normal source is available.
2. Light to indicate if the emergency source is available.
3. Light to indicate if the NORMAL position is energized, that is, the normal switching device in the automatic transfer switch is closed.
4. Light to indicate if the EMERGENCY position is energized, that is, the emergency switching device in the automatic transfer switch is closed.
5. Push-to-test button allows testing of the transfer switch. Pushing the button will simulate a power failure, causing the transfer switch to start the transfer sequence. If the push button is held down, the transfer switch will transfer the load to the emergency switch. Releasing the button will restore regular power.
6. Three-position selector switch to control the generator:
  - AUTO — The intelligence circuit of the transfer switch will start the generator if the normal power source is not available.
  - OFF — The intelligence circuit of the transfer switch will not be able to start the generator, which eliminates nuisance starts during maintenance.
  - RUN — The generator will run regardless of the availability of the normal power source.

The right control panel has the following standard features:

1. Light to indicate if the normal switching device is



Figure 7-1 Bypass Isolation Switch

- isolated (only if the normal switching device is racked out).
2. Light to indicate if the emergency switching device is isolated (only if the emergency switching device is racked out).
3. Light to indicate if the normal bypass switching device is closed.
4. Light to indicate if the emergency bypass switching device is closed.

### 7.2 AUTOMATIC OPERATION

The intelligence/supervisory circuits on Cutler-Hammer transfer switches constantly monitor the condition of both the normal and emergency power sources. These

circuits automatically initiate an immediate transfer of power from the normal to the emergency source when the power source fails or the voltage level drops below a preset value. Transfer back to the normal power source is automatic upon return of the normal power source.

Monitoring the power source is always performed on the line side of the power source to which the switch is connected. The normal power source is the preferred source and the transfer switch will always seek this source when it is available.

### 7.3 BYPASSING THE TRANSFER SWITCH



## WARNING

**THIS PRODUCT CONTAINS A SPECIAL CONTACT ARRANGEMENT (OVERLAPPING CONTACTS). MISUSE CAN RESULT IN DEATH, SEVERE PERSONAL INJURY AND/OR PROPERTY DAMAGE.**

#### 7.3.1 NORMAL TO NORMAL BYPASS

The normal switching device can be bypassed and isolated by the following sequence (Figure 7-2):

1. Move the generator selector switch to the OFF position to avoid nuisance starts.
2. Remove the key from the emergency switching device by turning it counterclockwise while pushing up on the lever next to the key interlock. This will lock the emergency switching device to prevent it from closing.
3. Insert the key in the normal bypass switching device and turn it clockwise, which will release the lever to the left of the key interlock. This will unlock the normal bypass switching device.
4. Close the normal bypass switch manually. The normal bypassed light will illuminate.
5. Open and rack out the normal switching device (see Section 6). The normal isolated light will illuminate. The normal position energized light will no longer be illuminated.
6. Inspect and/or perform maintenance on the normal switching device.
7. Rack in the normal switching device (see Section 6). The normal switching device will automatically recharge and close when it is in the CONNECT position. The normal isolated light will no longer be illuminated, but the NORMAL position energized light will be illuminated.
8. Open the normal bypass switch. The normal bypassed light will no longer be illuminated.
9. Remove the key from the normal bypass switch by turning the key counterclockwise while pushing up on the lever next to the key interlock. This will lock the normal bypass switch to prevent it from closing.
10. Insert the key in the emergency switch and turn the key clockwise, which will release the lever to the left of the key interlock. This will unlock the emergency switching device.
11. The normal switching device is now back in automatic operation.

#### 7.3.2 EMERGENCY TO EMERGENCY BYPASS

The emergency switching device can be bypassed and isolated by the following sequence:

1. Move the generator selector switch to the RUN position to avoid losing power.
2. Remove the key from the normal switching device by turning the key counterclockwise while pushing up on the lever next to the key interlock. This will lock the normal switching device and prevent it from closing.
3. Insert the key in the emergency bypass switching device and turn the key clockwise to release the lever to the left of the key interlock. This will unlock the emergency bypass switching device.
4. Close the emergency bypass switching device manually. The emergency bypass light will illuminate.
5. Open and rack out the emergency switching device (see Section 6). The emergency isolated light will illuminate, and the emergency position energized light will no longer be illuminated.
6. Inspect and/or perform maintenance on the emergency switching device.
7. Rack in the emergency switching device (see Section 6). The emergency switching device will automatically recharge and close when in the CONNECT position. The emergency isolated light will no longer be illuminated, and the emergency position

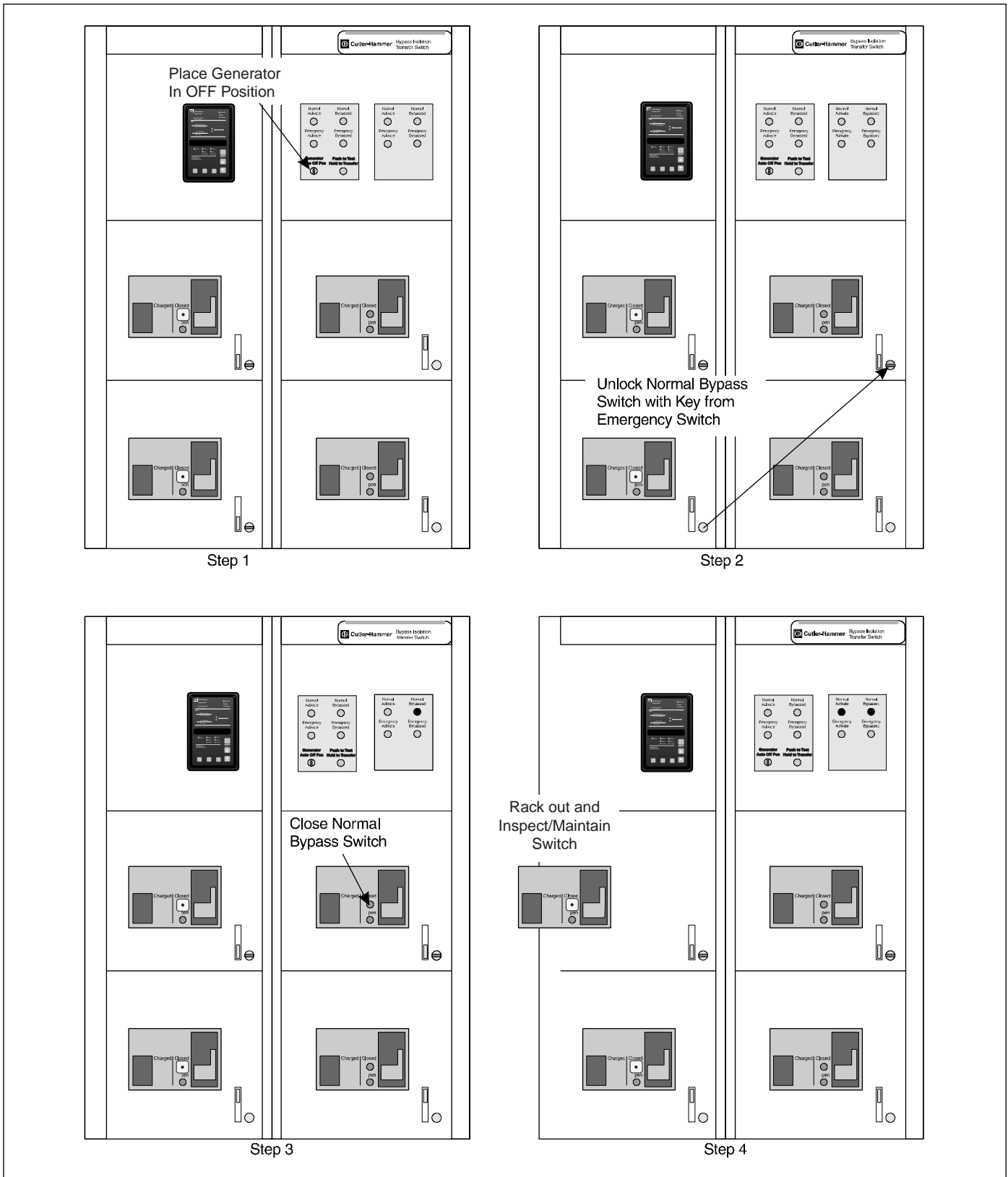

Figure 7-2a Transfer from Normal Switching Device to Normal Bypass Switching Device, Steps 1-4

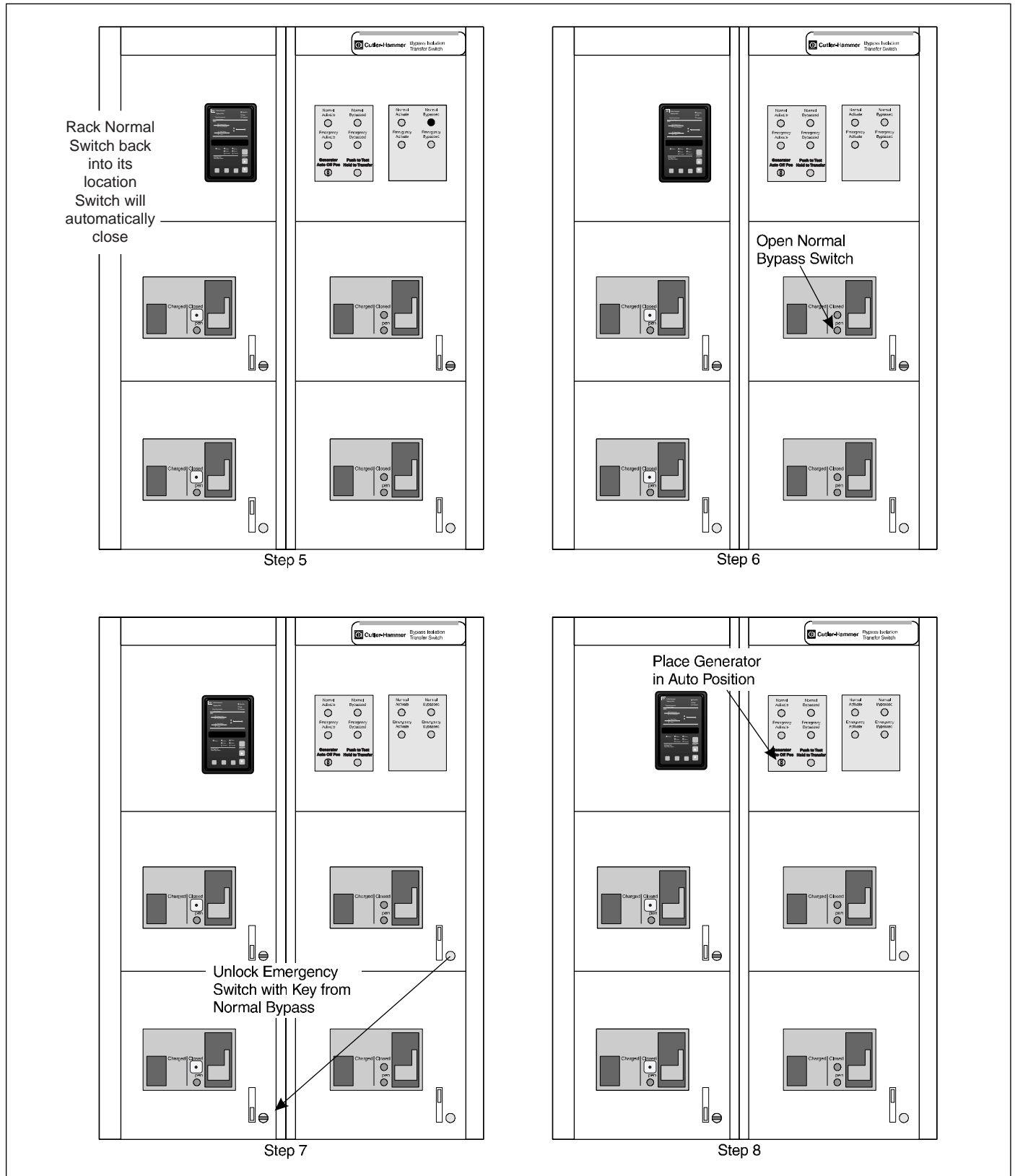

Figure 7-2b Transfer from Normal Switching Device to Normal Bypass Switching Device, Steps 5-8

8. Open the emergency bypass switch. The emergency bypassed light will no longer be illuminated.
9. Remove the key from the emergency bypass switch by turning the key counterclockwise while pushing up on the lever next to the key interlock. This will lock the emergency bypass switch and prevent it from closing.
10. Insert the key in the normal switch and turn it clockwise to release the lever to the left of the key interlock. This will unlock the normal switch.
11. The normal switch is now back in automatic operation.

## 7.4 MANUAL OPERATION WHEN IN BYPASS MODE

### 7.4.1 NORMAL BYPASS TO EMERGENCY BYPASS

When the transfer switch is set to normal bypass, it can be transferred to emergency bypass by the following sequence:

1. Move the generator selector switch to the RUN position.
2. Remove the key from the normal switching device by turning it counterclockwise while pushing up on the lever next to the key interlock. The normal switching device is now locked and prevented from closing.
3. Insert the key in the emergency bypass switching device and turn it clockwise to release the lever to the left of the key interlock. This will unlock the emergency bypass switching device.

4. Open the normal bypass switching device. The normal bypassed light will no longer be illuminated.
5. Close the emergency bypass switching device manually and the emergency bypassed light will illuminate.

### 7.4.2 EMERGENCY BYPASS TO NORMAL BYPASS

When the transfer switch is set to emergency bypass it can be transferred to the normal bypass switching device by the following sequence:

1. Remove the key from the emergency switching device by turning it counterclockwise while pushing up on the lever next to the key interlock. The emergency switching device is now locked and prevented from closing.
2. Insert the key in the normal bypass switching device and turn it clockwise to release the lever to the left of the key interlock. This will unlock the normal bypass switching device.
3. Open the emergency bypass switching device and the emergency bypassed light will no longer be illuminated.
4. Close the normal bypass switching device manually and the normal bypassed light will illuminate.
5. Move the generator selector switch to the OFF position.

## SECTION 8: TESTING AND PROBLEM SOLVING

### 8.1 TESTING

After transfer switch equipment is initially installed or during planned outages, the installation should be tested to insure that all equipment operates properly. This attention to detail will help to avoid unexpected malfunctions. Mechanical and/or electrical tests should be performed.

The frequency of subsequent testing should be based on recommendations of the generator set manufacturer. Use the test pushbutton to check the electrical operation of the switch. **IF A TEST SWITCH IS PROVIDED, ALWAYS RETURN THE SWITCH TO THE AUTO POSITION AFTER THE TEST IS COMPLETE.**



### WARNING

**HIGH VOLTAGES ASSOCIATED WITH OPERATIONAL TRANSFER SWITCH EQUIPMENT PRESENT A SHOCK HAZARD THAT CAN CAUSE SEVERE PERSONAL INJURY OR DEATH. USE EXTREME CAUTION TO AVOID TOUCHING ELECTRICAL CONNECTIONS WHENEVER INSPECTING OR TESTING THE EQUIPMENT.**

**IN ADDITION, IMPROPER OPERATION OF THE GENERATOR SET PRESENTS A HAZARD THAT CAN CAUSE SEVERE PERSONAL INJURY OR DEATH. OBSERVE ALL SAFETY PRECAUTIONS IN YOUR GENERATOR SET OPERATIONS AND INSTALLATION MANUALS.**

For mechanical operations, refer to Section 5 in this instruction book. Refer to the applicable logic instruction book for electrical testing.

### 8.2 PROBLEM SOLVING



### WARNING

**HAZARDOUS VOLTAGES IN AND AROUND TRANSFER SWITCH EQUIPMENT DURING THE PROBLEM SOLVING PROCESS CAN CAUSE PERSONAL INJURY AND/OR DEATH. AVOID CONTACT WITH ANY VOLTAGE SOURCE WHILE PROBLEM SOLVING.**



### WARNING

**ONLY PROPERLY TRAINED PERSONNEL FAMILIAR WITH THE TRANSFER SWITCH EQUIPMENT AND ITS ASSOCIATED EQUIPMENT SHOULD BE PERMITTED TO PERFORM THE PROBLEM SOLVING FUNCTION. IF AN INDIVIDUAL DOES NOT FEEL QUALIFIED TO PERFORM THE PROBLEM SOLVING FUNCTION, THE INDIVIDUAL SHOULD NOT ATTEMPT TO PERFORM ANY OF THESE PROCEDURES.**

A basic problem solving effort is the first step to take prior to calling for assistance. Frequently, the effort will successfully address most problems encountered. Most problem solving procedures are outlined in the instruction manual unique to the type of logic being used. In addition, several problem solving procedures are presented here which are specific to the type of switches or circuit breakers used in this equipment.

If a problem persists after having completed the problem solving procedure, contact a Cutler-Hammer representative for further assistance. When calling for assistance, the following is the minimum information required to properly address the need:

1. Shop Order Number (SO#) or General Order Number (GO#) of transfer switch, plus related Item Number
2. Catalog and/or Style Number of transfer switch
3. Actual location of transfer switch (type of facility, address, etc.)
4. Company name
5. Name and position of individual representing company
6. Basic description of situation as it exists
7. Any results of problem solving steps taken and/or readings taken



### WARNING

**THIS PRODUCT CONTAINS A SPECIAL CONTACT ARRANGEMENT (OVERLAPPING CONTACTS). MISUSE CAN RESULT IN DEATH, SEVERE PERSONAL INJURY AND/OR PROPERTY DAMAGE.**

### 8.2.1 TRANSFER SWITCH APPEARS INOPERATIVE

**Step 1:** Verify that all plugs and sockets are properly interconnected.

**Step 2:** Verify that the correct system voltage appears at NORMAL switch. Measure the voltage at the breaker lugs.

**Step 3:** Verify that the voltage selection plug is in the proper position to match the system voltage.

**Step 4:** Look for any obviously burned components. Determine the cause and rectify, if possible. Replace defective components after the cause is determined.

**Step 5:** Refer to Figure 5-2 for manual operating instructions. Verify whether or not the system voltage now appears on the load terminals.

If YES: Proceed to check logic for problems in respective logic instruction book.

If NO: Check all power connections and the switching mechanism.

### 8.2.2 TRANSFER SWITCH WILL NOT AUTOMATICALLY TRANSFER TO NORMAL

**Step 1:** Check for proper line voltage on N1, N2, N3.

**Step 2:** Is the normal switching device charged?

If YES: Continue with other procedures.

If NO: Go through section 8.2.4 first before continuing.

**Step 3:** Is the emergency switch OPEN?

If YES: Proceed to Step 5.

If NO: Proceed to Step 4.

**Step 4:** Measure voltage between terminals A9 and A8 on the emergency switching device (shunt trip). Does the voltage measure 120 VAC  $\pm$ 10 volts? Record reading.

If YES: Check shunt trip in emergency switch

If NO: Check wiring to A9 and A8.

**Step 5:** Measure voltage between terminals A1 and A2 on the normal switching device (spring release coil). Does the voltage measure 120 VAC  $\pm$  10 volts? Record reading.

If YES: Check spring release coil in normal switching device.

If NO: Check wiring to A1 and A2.

### 8.2.3 TRANSFER SWITCH WILL NOT AUTOMATICALLY TRANSFER TO EMERGENCY

**Step 1:** Check for proper line voltage on E1, E2, E3.

**Step 2:** Is the emergency switching device charged?

If YES: Continue with other procedures.

If NO: Go through Section 8.2.4 first before continuing.

**Step 3:** Is the normal switching device OPEN?

If YES: Proceed to Step 5.

If NO: Proceed to Step 4.

**Step 4:** Measure voltage between terminals A9 and A8 on the normal switching device (shunt trip). Does the voltage measure 120 VAC  $\pm$  10 volts?

If YES: Check shunt trip in normal switch

If NO: Check wiring to A9 and A8.

**Step 5:** Measure voltage between terminals A1 and A2 on the emergency switching device (spring release coil). Does the voltage measure 120 VAC  $\pm$  10 volts? Record reading.

If YES: Check spring release coil in emergency switch.

If NO: Check wiring to A1 and A2.

### 8.2.4 TRANSFER SWITCH WILL NOT AUTOMATICALLY RECHARGE SWITCHES

**Step 1:** Measure the voltage between the terminals A6 and A2 on the switching device that does not automatically recharge. Does the voltage read 120 VAC  $\pm$  10 volts? Record reading.

If YES: Check electrical operator inside the switching device.

If NO: Verify wiring to A6 and A2.

**Step 2:** If problem persists contact Cutler-Hammer.

## SECTION 9: MAINTENANCE

### 9.1 INTRODUCTION



#### WARNING

---

**HIGH VOLTAGES ARE PRESENT IN AND AROUND TRANSFER SWITCH EQUIPMENT. BEFORE INSPECTING OR MAINTAINING THIS EQUIPMENT, DISCONNECT LINE POWER FROM THE EQUIPMENT BEING SERVICED BY OPENING AND LOCKING OUT, IF POSSIBLE, THE NEXT HIGHEST DISCONNECT DEVICE. FAILURE TO FOLLOW THIS PROCEDURE COULD CAUSE PERSONAL INJURY AND/OR DEATH.**

---



#### WARNING

---

**THIS PRODUCT CONTAINS A SPECIAL CONTACT ARRANGEMENT (OVERLAPPING CONTACTS). MISUSE CAN RESULT IN DEATH, SEVERE PERSONAL INJURY AND/OR PROPERTY DAMAGE.**

In general, transfer switch equipment is designed to be relatively maintenance free under normal usage. However, because of the variability of application conditions and the importance placed on dependable operation by this type of equipment, inspection and maintenance checks should be made on a regularly scheduled basis. Since equipment maintenance will consist mainly of keeping the equipment clean, the frequency of maintenance will depend, to a large extent, on the cleanliness of the surroundings. If a significant amount of dust or foreign matter is present, a more frequent maintenance schedule should be followed.

It is suggested that visual inspections of the equipment be made on a regular basis, not just during regularly scheduled periods. Always be alert for an accumulation of dirt in and around the structure, loose parts and/or hardware, cracks and/or discoloration to insulation, and damaged or discolored components.

### 9.2 PROCEDURES

A suggested maintenance procedure to follow is outlined in Table 9.1.

Table 9.1 Periodic Maintenance Procedures

Step	Action
a. Make transfer switch equipment safe for inspection and/or maintenance.	Disconnect line power from equipment being serviced by opening next highest disconnect device. Make certain that any accessory control power is switched off and logic plugs disconnected.
b. Inspect structure area for safety hazards or potential maintenance problems.	<p>Inspect area, especially where switching devices are installed, for any safety hazards, including personnel safety and fire hazards. Exposure to certain chemical vapors can cause deterioration of electrical connections.</p> <p>Inspect for accumulated dirt, loose hardware or physical damage.</p> <p>Examine primary insulation for evidence of cracking or overheating. Overheating will show as discoloration, melting, or blistering of conductor insulation, or as pitting or melting of conductor surfaces due to arcing.</p> <p>Inspect secondary control connections for damage, and control wiring for insulation integrity.</p>
c. Inspect switching devices for dust, dirt, soot, grease, moisture or corrosion.	Remove dust, dirt, soot, grease, moisture and corrosion contamination from the surface of the switching device using a dry soft lint-free cloth, dry soft bristle brush and vacuum cleaner. Do not blow debris into circuit breaker or nearby breaker structure. If contamination is found, look for the source and fix the problem.
d. Check for material integrity, uneven wear, discoloration or loose hardware.	Severe material cracking will require replacement and loose hardware will need to be tightened.
e. Check terminals and connectors for looseness or signs of overheating.	<p>Overheating will show as discoloration, melting, or blistering of conductor insulation.</p> <p>Connections that do not have signs of looseness or overheating should not be disturbed.</p>
f. Exercise the switching devices if they are not often exercised while in operation. This will permit wiping action by the contacts.	If a switching device is used for frequent switching during normal operation, this step can be disregarded.
g. Return transfer switch equipment to service.	Make certain all barriers are in place and doors closed. Re-apply secondary and primary power.



This instruction booklet is published solely for information purposes and should not be considered all inclusive. If further information is required, you should consult Cutler-Hammer.

Sale of product shown in this literature is subject to terms and conditions outlined in appropriate Cutler-Hammer selling policies or other contractual agreement between the parties. This literature is not intended to and does not enlarge or add to any such contract. The sole source governing the rights and remedies of any purchaser of this equipment is the contract between the purchaser and Cutler-Hammer.

NO WARRANTIES, EXPRESSED OR IMPLIED, INCLUDING WARRANTIES OF FITNESS FOR A PARTICULAR PURPOSE OR MERCHANTABILITY, OR WARRANTIES ARISING FROM COURSE OF DEALING OR USAGE OF TRADE, ARE MADE REGARDING THE INFORMATION, RECOMMENDATIONS AND DESCRIPTIONS CONTAINED HEREIN. In no event will Cutler-Hammer be responsible to the purchaser or user in contract, in tort (including negligence), strict liability or otherwise for any special, indirect, incidental or consequential damage or loss whatsoever, including but not limited to damage or loss of use of equipment, plant or power system, cost of capital, loss of power, additional expenses in the use of existing power facilities, or claims against the purchaser or user by its customers resulting from the use of the information, recommendations and description contained herein.

**Cutler-Hammer**

Pittsburgh, Pennsylvania U.S.A.

---

Effective 5/98 (ISI)  
Style 68B2507  
Printed in U.S.A.

**EAT•N**