



## Instructions for Cutler-Hammer Genswitch Automatic Transfer Switch (30-1000 Amperes)







**WARNING**

READ AND UNDERSTAND THE INSTRUCTIONS CONTAINED HEREINAFTER BEFORE ATTEMPTING TO UNPACK, ASSEMBLE, OPERATE OR MAINTAIN THIS EQUIPMENT.

HAZARDOUS VOLTAGES ARE PRESENT INSIDE TRANSFER SWITCH ENCLOSURES THAT CAN CAUSE DEATH OR SEVERE PERSONAL INJURY. FOLLOW PROPER INSTALLATION, OPERATION AND MAINTENANCE PROCEDURES TO AVOID THESE VOLTAGES.

TRANSFER SWITCH EQUIPMENT COVERED BY THIS INSTRUCTION BOOK IS DESIGNED AND TESTED TO OPERATE WITHIN ITS NAMEPLATE RATINGS. OPERATION OUTSIDE OF THESE RATINGS MAY CAUSE THE EQUIPMENT TO FAIL RESULTING IN DEATH, SERIOUS BODILY INJURY AND/OR PROPERTY DAMAGE. ALL RESPONSIBLE PERSONNEL SHOULD LOCATE THE DOOR MOUNTED EQUIPMENT NAMEPLATE AND BE FAMILIAR WITH THE INFORMATION PROVIDED ON THE NAMEPLATE. A TYPICAL EQUIPMENT NAMEPLATE IS SHOWN IN FIGURE 1.

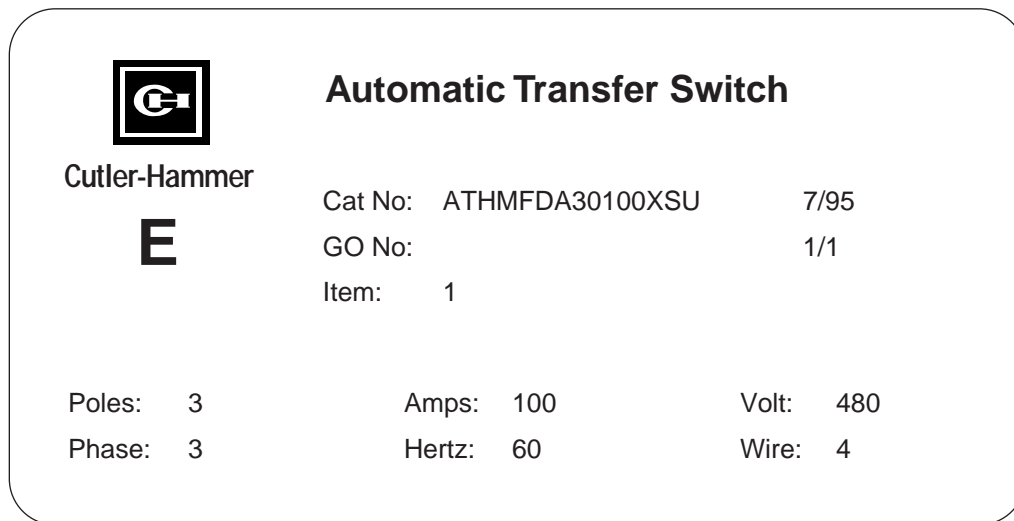

Figure 1 Typical Automatic Transfer Switch Equipment Nameplate

*All possible contingencies which may arise during installation, operation or maintenance, and all details and variations of this equipment do no purport to be covered by these instructions. If further information is desired by purchaser regarding his particular installation, operation or maintenance of particular equipment, contact a Cutler-Hammer representative.*

TABLE OF CONTENTS

	<b>Page</b>
<b>SECTION 1: INTRODUCTION</b>	
1.1 Preliminary Comments and Safety Precautions.....	1
1.1.1 Warranty and Liability Information.....	1
1.1.2 Safety Precautions.....	1
1.2 General Information.....	1
1.2.1 Design Configuration.....	2
1.3 Transfer Switch Catalog Number Identification.....	3
<b>SECTION 2: RECEIVING, HANDLING AND STORAGE</b>	
2.1 Receiving.....	4
2.2 Handling.....	4
2.3 Storage.....	4
<b>SECTION 3: EQUIPMENT DESCRIPTION</b>	
3.1 General.....	5
3.2 Power Panel.....	5
3.2.1 Steel Base Plate.....	5
3.2.2 Main Contacts.....	5
3.2.3 Transfer Mechanism (225-1000A).....	5
3.2.4 Transfer Mechanism (30-150A).....	5
3.3 Voltage Selection Panel.....	6
3.4 Microprocessor Based Logic Panel.....	6
3.5 Options.....	7
3.6 Enclosure.....	9
3.7 Standards.....	10
<b>SECTION 4: INSTALLATION AND WIRING</b>	
4.1 General.....	11
4.2 Mounting Location.....	11
4.3 Mounting Procedure.....	11
4.4 Load Lug Location.....	14
4.5 Power Cable Connections.....	16
4.6 Wiring.....	17
4.7 Engine Start Connection.....	17
4.8 Voltage Selection Adjustments.....	17
<b>SECTION 5: OPERATION</b>	
5.1 General.....	19
5.2 Manual Operation (225-1000A).....	19
5.3 Manual Operation (30-150A).....	20
5.4 Automatic Transfer.....	20
5.4.1 Normal Power Source Failure.....	20
5.4.2 Normal Power Source Restoration.....	21

**SECTION 6: TESTING AND PROBLEM SOLVING**

6.1	Testing .....	22
6.1.1	Mechanical and/or Electrical Testing.....	22
6.1.2	No Voltage Steps .....	22
6.1.3	Connecting Power Sources.....	22
6.1.4	Operational Checks.....	23
6.1.5	Alternative Tests.....	23
6.2	Problem Solving .....	23
6.2.1	Transfer Switch Appears Inoperative .....	24
6.2.2	Motor Keeps Turning and Transfer Switch will not Stop in Position.....	24
6.2.3	Transfer Switch will not Automatically Transfer to Normal .....	24
6.2.4	Transfer Switch will not Automatically Transfer to Emergency .....	25

**SECTION 7: MAINTENANCE**

7.1	General .....	27
7.2	Plant Exerciser Timer .....	27
7.2.1	Timer Programming.....	27
7.3	Microprocessor Based Logic.....	27
7.3.1	Voltage Sensing Functions.....	27
7.3.2	Frequency Sensing Functions.....	27
7.3.3	Time Delay Functions.....	27
7.3.4	On-Board Indicators .....	29
7.3.5	Instructions for Dip Switch Setting.....	29

**SECTION 8: MAINTENANCE**

8.1	Introduction.....	32
8.2	Procedures .....	32

## LIST OF FIGURES

Figure	Title	Page
1-1	Typical Load Transfer Switch (circuit breaker type) Schematic.....	1
1-2	Vertical Design Automatic Transfer Switch Equipment with Deadfront Cover in Place over Power Panel (225-1000 Amperes).....	2
3-1	Typical Power Panel (Unmounted) for 225-1000A Models.....	5
3-2	Typical Power Panel for 30-150A Models.....	6
3-3	Mounted Molded Case Switches with the Transfer Mechanism Removed for Clarity (225-1000A Models) .....	6
3-4	Vertical Design Voltage Selection Panel with Voltage Being Selected .....	6
3-5	Microprocessor-based Logic Control Panel.....	7
3-6	Device Panel on Front Cover.....	8
3-7	Typical Type 1 Enclosure (Door Closed) .....	9
4-1	Dimensions of Enclosed Automatic Transfer Switch and Approximate Weights.....	12
4-2	Typical (30-150 Amperes) Horizontal Design Transfer Switch Equipment (Door Open).....	13
4-3	Typical (225-1000 Amperes) Vertical Design Transfer Switch Equipment (Door Open and Deadfront Shield Removed).....	14
4-4	Mounted Load Lug Assembly (225-10 00A Models).....	15
4-5	Line Voltage Plug and Receptacles (shown with covers removed) for Horizontal Design .....	18
5-1	Motor Disconnect Being Unplugged .....	19
5-2	Transfer Switch Manula Operating Handle in Use (225-1000A Models).....	19
5-3	Indicator Wheel Mounted in the Switch with Motor Under the Wheel (225-1000A Models) .....	20
5-4	Indicator Wheel in Neutral Position (225-1000A Models) .....	20
5-5	Transfer Mechanism with Lever Removed (30-150A Model) .....	21
5-6	Switch Being Manually Operated (30-150A Model).....	21
7-1	Plant Exerciser Timer .....	27
7-2	Genswitch Microprocessor-based Logic Control Panel .....	28
8-1	Wiring Diagram for AGswitch Automatic Transfer Switch.....	33

## LIST OF TABLES

<b>Table</b>	<b>Title</b>	<b>Page</b>
1.1	Transfer Switch Catalog Number Explanation.....	3
3.1	Transfer Switch Equipment Enclosures.....	9
4.1	Bolted Bus Connection Torque Requirements .....	16
4.2	Transfer Switch Equipment Wire Sizes .....	17
7.1	Selection Grouping for DIP Switches.....	29
7.2	Parameters for Programming Undervoltage Pickup and Dropout for Normal Power Source .....	30
7.3	Parameters for Programming Undervoltage Pickup and Dropout for Emergency Power Source .....	30
7.4	Parameters for Programming Underfrequency Pickup and Dropout for Emergency Power Source .....	30
7.5	Range Selection for Time Delay Normal to Emergency (TDNE).....	30
7.6	Range Selection for Time Delay Emergency to Normal (TDEN).....	30
7.7	Range Selection for Time Delay Engine Cool Down (TDEC).....	30
7.8	Quick Reference for Actual Voltage Level Relative to Percentage of the Normal System Voltage.....	31
8.1	Periodic Maintenance Procedures.....	34



## SECTION 1: INTRODUCTION

### 1.1 PRELIMINARY COMMENTS AND SAFETY PRECAUTIONS

This technical document is intended to cover most aspects associated with the installation, application, operation and maintenance of the Genswitch with ratings from 30 through 800 amperes. It is provided as a guide for authorized and qualified personnel only. Please refer to the specific WARNING and CAUTION in Section 1.1.2 before proceeding. If further information is required by the purchaser regarding a particular installation, application or maintenance activity, a Cutler-Hammer representative should be contacted.

#### 1.1.1 WARRANTY AND LIABILITY INFORMATION

No warranties, expressed or implied, including warranties of fitness for a particular purpose of merchantability, or warranties arising from course of dealing or usage of trade, are made regarding the information, recommendations and descriptions contained herein. In no event will Cutler-Hammer be responsible to the purchaser or user in contract, in tort (including negligence), strict liability or otherwise for any special, indirect, incidental or consequential damage or loss whatsoever, including but not limited to damage or loss of use of equipment, plant or power system, cost of capital, loss of power, additional expenses in the use of existing power facilities, or claims against the purchaser or user by its customers resulting from the use of the information and descriptions contained herein.

#### 1.1.2 SAFETY PRECAUTIONS

All safety codes, safety standards and/or regulations must be strictly observed in the installation, operation and maintenance of this device.



## WARNING

THE WARNINGS AND CAUTIONS INCLUDED AS PART OF THE PROCEDURAL STEPS IN THIS DOCUMENT ARE FOR PERSONNEL SAFETY AND PROTECTION OF EQUIPMENT FROM DAMAGE. AN EXAMPLE OF A TYPICAL WARNING LABEL HEADING IS SHOWN ABOVE TO FAMILIARIZE PERSONNEL WITH THE STYLE OF PRESENTATION. THIS WILL HELP TO INSURE THAT PERSONNEL ARE ALERT TO WARNINGS, WHICH APPEAR THROUGHOUT THE DOCUMENT. IN ADDITION, CAUTIONS ARE ALL UPPER CASE AND BOLDFACE.



## CAUTION

**COMPLETELY READ AND UNDERSTAND THE MATERIAL PRESENTED IN THIS DOCUMENT BEFORE ATTEMPTING INSTALLATION, OPERATION OR APPLICATION OF THE EQUIPMENT. IN ADDITION, ONLY QUALIFIED PERSONS SHOULD BE PERMITTED TO PERFORM ANY WORK ASSOCIATED WITH THE EQUIPMENT. ANY WIRING INSTRUCTIONS PRESENTED IN THIS DOCUMENT MUST BE FOLLOWED PRECISELY. FAILURE TO DO SO COULD CAUSE PERMANENT EQUIPMENT DAMAGE.**

### 1.2 GENERAL INFORMATION

Transfer switches are used to protect critical electrical loads against loss of power. The load's normal power source is backed up by a secondary (emergency) power source. A transfer switch is connected to both the normal and emergency power sources and supplies the load with power from one of these two sources. In the event that power is lost from the normal power source, the transfer switch transfers the load to the secondary (emergency) power source. Transfer can be automatic or manual, depending upon the type of transfer switch equipment being used. Once normal power is restored,

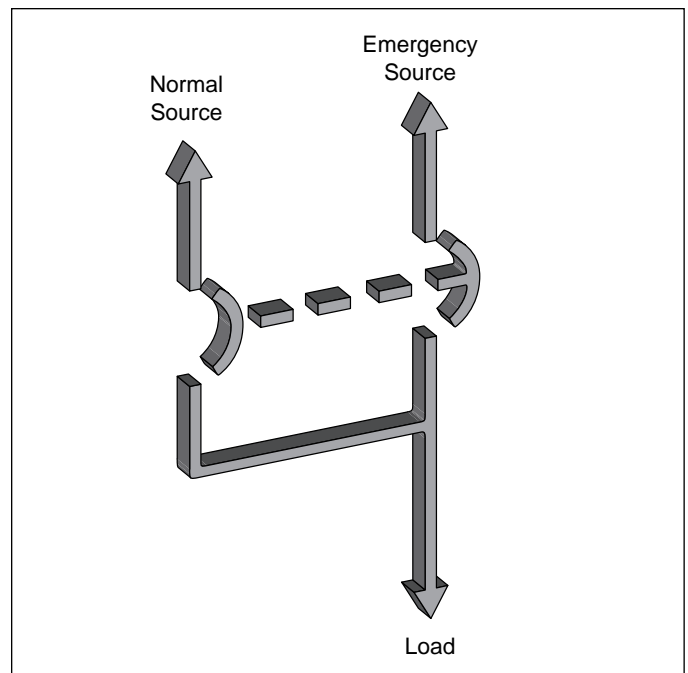

Figure 1-1 Typical Load Transfer Switch (circuit breaker type) Schematic

the load is automatically or manually transferred back to the normal power source, again depending upon the type of transfer equipment being used (Figure 1-1).

In automatic transfer switch equipment, the switch's intelligence system initiates the transfer when normal power fails or falls below a preset voltage. If the emergency power source is a standby generator, the transfer switch initiates generator starting and transfers to the emergency power source when sufficient generator voltage is available. When normal power is restored, the transfer switch automatically transfers back and initiates engine shutdown. In the event the normal power source fails and the emergency power source does not appear, the automatic transfer switch remains connected to the normal power source until the emergency power source does appear. Conversely, if connected to the emergency power source and the emergency power source fails while the normal power source is still unavailable, the automatic transfer switch remains connected to the emergency power source.

Automatic transfer switches automatically perform the transfer function, and include three basic elements:

- (1) Main contacts to connect and disconnect the load to and from the source of power.
- (2) A mechanism to make the transfer of the main contacts from source to source.
- (3) Intelligence/supervisory circuits to constantly monitor the condition of the power sources and thus provide the intelligence necessary for the switch and related circuit operation.

### 1.2.1 DESIGN CONFIGURATION

The Cutler-Hammer transfer switch is a rugged, compact design that used molded case switches to transfer essential loads from one power source to another (Figures 3-1 [225-1000A] and 3-2 [30-150A]). Molded case switches are interlocked to prevent both switching devices from being closed at the same time.

Molded case switches and the associated transfer mechanisms are mounted vertically to save space in the assembly. The compact, vertical configuration uses a positive, metallic transfer and interlocking system between the molded case switches.

The Cutler-Hammer automatic transfer switch was designed with easy installation and simplified maintenance in mind. Two main panels comprise the automatic transfer switch design:



*Figure 1-2 Vertical Design Automatic Transfer Switch Equipment with Deadfront Cover in Place Over Power Panel (225-1000 Amperes)*

- Power Panel
- Voltage selection and transformer panel
- Microprocessor-based logic panel

Each panel is independently mounted with interconnecting wiring terminated in connector plugs to permit individual door or panel removal without disturbing critical connections. Mounting the enclosure is simple using top and bottom mounting flanges with elongated mounting holes. These mounting holes, along with power panel positioning bolts and pre-tapped inserts insure proper power panel mounting after initial enclosure installation or when switching from top to bottom entry and vice versa. Refer to Section 4 for mounting and modification details.

**1.3 TRANSFER SWITCH CATALOG NUMBER IDENTIFICATION**

Transfer switch equipment catalog numbers provide a significant amount of relevant information that pertains to a particular piece of equipment. The Catalog Number Identification Table (Table 1.1) provides the required interpretation information. An example is offered to initially simplify the process.

**Example:** Catalog Number (*circled numbers correspond to position headings in Table 1.1*):

① to ② ③ ④ ⑤ to ⑥ ⑦ ⑧ ⑨ to ⑫ ⑬ ⑭ ⑮  
**AT H M KD A 3 0150 B S U**

The catalog number ATHMKDA30150BSU describes an Automatic Transfer Switch with the switching devices mounted horizontally in the enclosure. The intelligence represented by the control panel is solid state logic. The Cutler-Hammer Series C Type HKD is used as the switching device and is in the form of a 2-pole molded case switch on each source. The continuous current rating of this equipment is 225 amperes and applicable at 240VAC, 60Hz. The transfer switch equipment is enclosed in a NEMA 3R enclosure and is listed for UL applications.

**Table 1.1 Transfer Switch Catalog Number Explanation**

Positions 1-2		Position 3		Position 4		Positions 5-6		
Basic Device		Switching Device Orientation		Control Panel		Switching Device		
Automatic Transfer Switch	<b>AT</b>	Vertical	<b>V</b> <sup>①</sup>	Microprocessor	<b>M</b>	HFD	Cutler-Hammer Series C̄	<b>FD</b>
		Horizontal	<b>H</b> <sup>②</sup>			HKD	Cutler-Hammer Series C̄	<b>KD</b>
						HLD	Cutler-Hammer Series C̄	<b>LD</b>
						MA	Cutler-Hammer	<b>MA</b>
						NB	Cutler-Hammer	<b>NB</b>
						HND	Cutler-Hammer Series C̄	<b>ND</b> <sup>③</sup>

Position 7	Position 8	Positions 9-12	Position 13	Position 14	Position 15		
Switching Device Arrangement	Number of Poles	Ampere Rating	Voltage/Frequency	Enclosure	Listing		
Fixed Mount Molded Case Switches Both Power Sources	Two	2	30A – 0030	120VAC/60Hz	<b>A</b>	UL Listed	<b>U</b>
			70A – 0070	208VAC/60Hz	<b>B</b>		
	Three	3	100A – 0100	600VAC/60Hz	<b>E</b>		
			150A – 0150	220VAC/50 or 60Hz	<b>G</b>		
	Four	4	225A – 0225	380VAC/50Hz	<b>H</b>		
			300A – 0300	600VAC/50Hz	<b>K</b>		
			400A – 0400	230VAC/50Hz	<b>M</b>		
			600A – 0600	401VAC/50Hz	<b>N</b>		
			800A – 0800	415VAC/50Hz	<b>O</b>		
			1000A – 1000	240VAC/60Hz	<b>W</b>		
				480VAC/60Hz	<b>X</b>		
			365VAC/50Hz	<b>Z</b>			

- ① Vertical orientation (225-1000 amperes)
- ② Horizontal orientation (30-150 amperes)
- ③ Contact factory for availability

## SECTION 2: RECEIVING, HANDLING, AND STORAGE

### 2.1 RECEIVING

Every effort is made to ensure that the transfer switch equipment arrives at its destination undamaged and ready for installation. Packing is designed to protect internal components as well as the enclosure. Care should be exercised, however, to protect the equipment from impact at all times. Do not remove protective packaging until the equipment is ready for installation .

When transfer switch equipment reaches its destination, the customer should inspect the shipping container for any obvious signs of rough handling and/ or external damage that occurred during transportation. Record any external and internal damage for reporting to the transportation carrier and Cutler-Hammer, once a thorough inspection is complete. All claims should be as specific as possible and include Shop Order and General Order numbers.

A shipping label affixed to the shipping container includes a variety of equipment and customer information, such as General Order number and Customer Number. Make certain that this information matches other shipping paper information.

Each transfer switch enclosure is bolted through its top and bottom mounting flanges to a rigid wooden pallet. The pallet is open at two ends for movement by a forklift. Heavy duty cardboard sides surround the enclosure and are further supported with reinforced cardboard corner posts. An egg crate design cardboard protector covers the entire top of the enclosure with additional cardboard protectors over the indicating light panel and operating handle. A heavy duty cardboard lid covers the entire opening. The shipment is secured and further protected with shrink wrap. Do not discard the packing material until the equipment is ready for installation.

Once the top packaging is removed from the shipment, the enclosure door can be opened. A plastic bag of documents will be found in the enclosure, usually attached to the inside of the door. Important documents, such as test reports, wiring diagrams, appropriate instruction leaflets and a warranty registration card, are enclosed within the bag and should be filed in a safe place.

### 2.2 HANDLING

As previously mentioned, transfer switch equipment is packaged for forklift movement. Protect the equipment from impact at all times and do not double stack. Once the equipment is in the installation location and ready to be installed, packaging material can be removed. Once the enclosure is unbolted from the wooden pallet, it can be hand moved to its installation position. Be careful not to damage the top or bottom enclosure mounting flanges. Refer to Section 4 of this manual for specific installation instructions.

### 2.3 STORAGE

Although well packaged, this equipment is not suitable for storage outdoors. The equipment warranty will not be applicable if there is evidence of outdoor storage. If the equipment is to be stored indoors for any period of time, it should be stored with its protective packaging material in place. Protect the equipment at all times from excessive moisture, construction dirt, corrosive conditions, and other contaminants. It is strongly suggested that the package-protected equipment be stored in a climate-controlled environment of -20°C to 65°C with a relative humidity of 80 percent or less. Do not under any circumstance, stack other equipment on top of a transfer switch equipment enclosure, whether packaged or not.

## SECTION 3: EQUIPMENT DESCRIPTION

### 3.1 GENERAL

The Genswitch consists of three basic panels interconnected via connector plugs and mounted in an enclosure (Figures 4-2 and 4-3).

### 3.2 POWER PANEL

The power panel is used for making load, power, and neutral connections. The main contacts and the transfer mechanism are all on one steel frame (Figure 3-1 and 3-2).

#### 3.2.1 STEEL BASE PLATE

The steel base plate design (225-1000 A models only) permits the power panel to be moved vertically within the enclosure to accommodate top or bottom cable entry (Figure 4-1). Elongated holes on either side of the base plate ensure proper positioning. The bottom set of elongated holes positions the power panel higher in the enclosure, thus permitting bottom cable entry. The top set of elongated holes positions the power panel lower in the enclosure for top cable entry. Section 4 discusses equipment mounting and load lug location in detail.

#### 3.2.2 MAIN CONTACTS

The main contacts connect and disconnect the load to and from the different power sources. High withstand molded case switches are the main contacts for the normal and emergency power sources in standard Genswitch automatic transfer switches (Figure 3-3 and Section 3.7). These continuous duty transfer switches are rated for all classes of loads, open or enclosed.

In addition, they have high dielectric strength, heavy-duty switching and withstand capabilities, and high interruption capacity. This transfer switch incorporates Cutler-Hammer-type molded case switches.

The switching devices are mechanically and electrically interlocked to prevent the two sets of main contacts from being closed simultaneously. The load side contacts of each switching device are joined with a bus bar assembly to form a common load terminal location, either top or bottom (Figures 4-2 and 4-3).

#### 3.2.3 TRANSFER MECHANISM (225-1000A)

The transfer mechanism transfers between power sources through a motor-driven, ratchet-type operation. A rotational motion is created on an indicator wheel by the ratchet's operation. The indicator wheel is attached

to rigid shafts which convert the rotary motion into vertical linear motion. Opening and closing the switching devices is accomplished as a result of this vertical linear motion. The transfer mechanism is mounted in front of the molded case switches (Figure 3-1).

A solid steel shield attached to the ratchet assembly permits viewing of the rotary switch position indicator while restricting access to other parts of the power panel (Figure 1-2).

#### 3.2.4 TRANSFER MECHANISM (30-150A)

This mechanism transfers between power sources using a motor-driven arm that connects to a lever which operates both the normal and emergency switches (Figure 3-2).

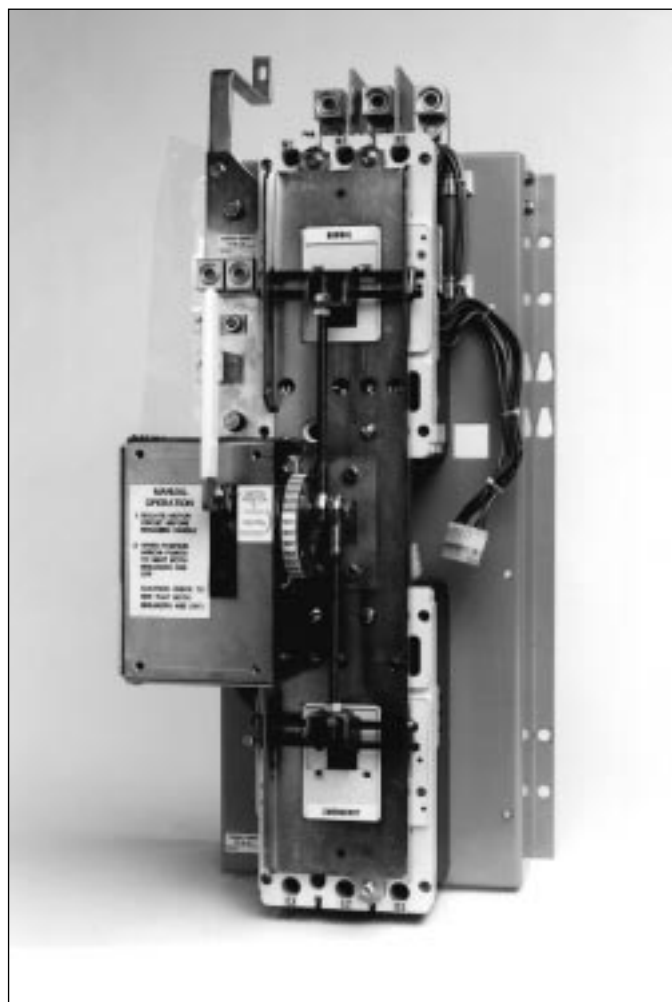

Figure 3-1 Typical Power Panel (Unmounted) for 225-1000A Models

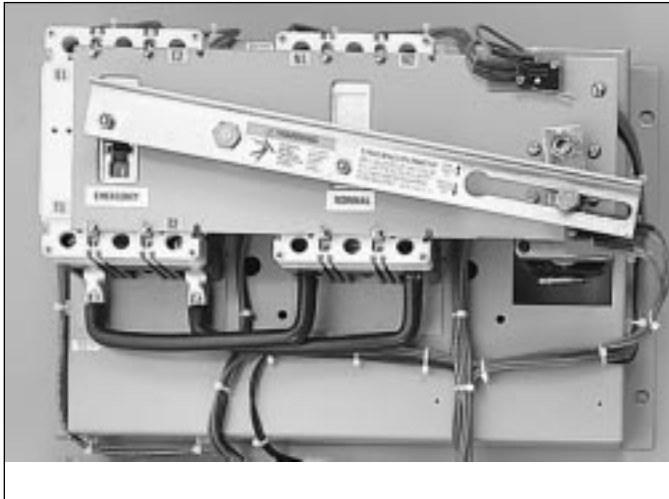

Figure 3-2 Typical Power Panel for 30-150A Models



Figure 3-4 Vertical Design Voltage Selection Panel with Voltage Being Selected

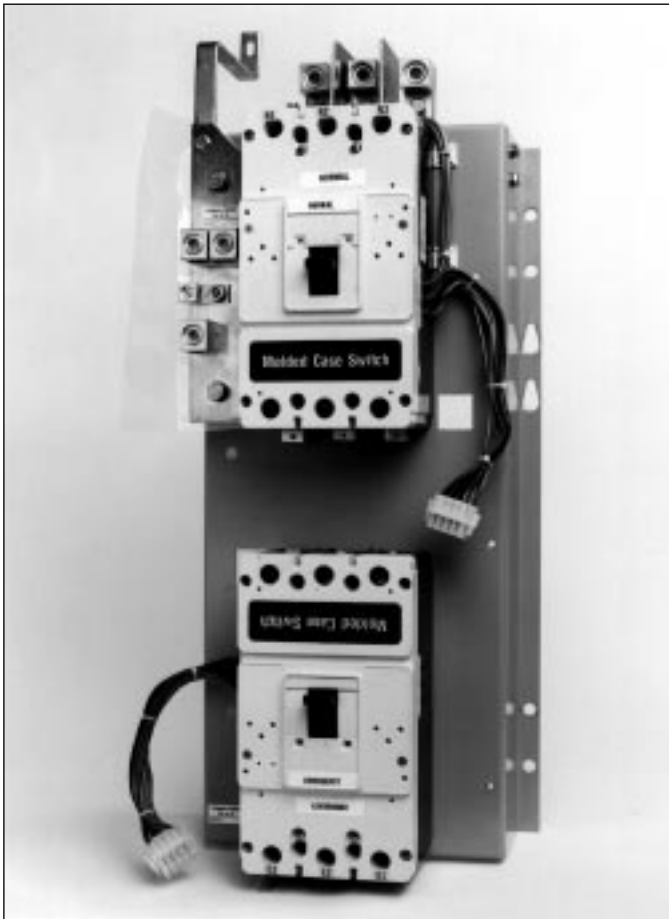

Figure 3-3 Mounted Molded Case Switches with the Transfer Mechanism Removed for Clarity (225-1000A Models)

### 3.3 VOLTAGE SELECTION PANEL

The voltage selection panel is a multi-tap enclosed transformer mounted in the enclosure (Figure 3-4). Seven front accessible voltages taps from 208 to 600 volts AC satisfy any required application voltage. A quick change capability from one voltage to another is provided by a small disconnect plug.

### 3.4 MICROPROCESSOR BASED LOGIC PANEL

The Genswitch is a microprocessor-based transfer switch logic control package. The hardware and software of the controller contain the intelligence/supervisory circuits that constantly monitor the condition of the power sources. It provides the intelligence necessary for the operation of the transfer switch (Figure 3-5).

The ATS controller has an operating temperature of -20 to 75° C.

The Controller circuit board is protected by an insulating conformal coating.



Figure 3-5 Microprocessor-based Logic Control Panel

The specifications under normal operating conditions are as follows:

- Tolerance for voltage sensing function:  
±2% of setting
- Tolerance for frequency sensing function:  
±0.2 Hz of setting
- Accuracy of time delay range:  
±2% of setting
- Dial settings for delay time:  
±5% of indication

### 3.5 OPTIONS

A variety of switch options are available to meet a wide variety of application requirements. Individual options or option combinations permit a switch to be tailored to individual needs. Options are numbered with an associated description. More detailed selections that must be made within a specific option are lettered.

#### 1. Time Delay Normal to Emergency (TDNE) (Standard)

This option delays the transfer from the normal power source to the emergency power source in order to override momentary normal power source outages and/or fluctuations. Timing begins when the emergency power source becomes available. It does not affect initiation of the engine start circuit. Should the normal power source fail, the engine start contact will immediately close, and if connected to an engine generator, will initiate an engine start-up. The timer is user-adjustable over four ranges covering 0.1 seconds to 200 minutes. **This option is labeled TDNE and is located on the microprocessor control panel. See Section 7.3 for further details on settings.**

#### 2. Time Delay on Engine Starting (TDES) (Standard)

This option is used only where the emergency power source is an engine generator. It delays initiation of the engine start circuit in order to override momentary normal power source outages and/or fluctuations. It does not affect the transfer switch's ability to transfer from normal power source to the emergency power source. The timer is user adjustable over two ranges covering 0.5 seconds to 15 seconds. **This option is labeled TDES and is located on the microprocessor control panel. See Section 7.3 for further details on settings.**

#### 2B. Adjustable 0 to 20 or 20 to 40 seconds

#### 3. Time Delay Emergency to Normal (TDEN) (Standard)

This option delays the transfer from the emergency power source to the normal power source, allowing for stabilization of the normal power source before the transfer is initiated. Timing begins when the normal source becomes available. If the emergency power source fails during timing, the time delay is overridden and an immediate transfer to the normal power source will occur. The timer is user-adjustable over 4 ranges covering 0.1 seconds to 200 minutes. **This option is labeled TDEN and is located on the microprocessor control panel. See Section 7.3 for further details on settings.**

#### 4. Time Delay for Engine Cool-Off (TDEC) (Standard)

This option enables the generator to run under a no-load condition after transfer to the normal power source has been made. Timing begins immediately after the transfer has been made. The timer is user adjustable over four ranges covering 0.1 seconds to 200 minutes. **This option is labeled TDEC and is located on the microprocessor control panel. See Section 7.3 for further details on settings.**

#### 5. Frequency/Voltage Sensing for Emergency Source (Standard)

This option enables the microprocessor to constantly monitor the emergency power source. The microprocessor prevents transfer from normal power source to the emergency power source until the emergency power source has reached an acceptable operating frequency and/or voltage. When the transfer switch is connected to the emergency power source and the emergency power source is outside the microprocessor frequency or voltage settings, the transfer switch will initiate a transfer to the normal power source, if the normal power source is available.

**5B. 1-Phase Undervoltage/Under Frequency**

**12. Pilot Lights (Standard)**

*Transfer Switch Position*

**12C. Normal (Green)**

Illuminates when the normal power source is available and the transfer switch is connected to the normal source.

**12.D Emergency (Red)**

Illuminates when the emergency power source is available and the transfer switch is connected to the emergency power source.

**14. Auxiliary Relay Contact (Standard)**

**14C. Normal Power Source**

This option provides two NO and two NC contacts. The relay is energized only when the normal power source is available and the transfer switch is connected to the normal power source. **This option is labeled as NRA and is mounted on the voltage selection panel.**

**14D. Emergency Power Source**

This option provides 2 NO and 2 NC contacts. The relay is energized when the emergency power source is available. **This option is labeled ERA and is mounted on the voltage selection panel.**

**16. Integral Overcurrent Protection (Optional)**

Use of the option can, in many cases, eliminate the need for separate upstream, overcurrent/short circuit protection and provide significant material, labor, and space savings over other system layouts. In addition to overcurrent protection, for safety purposes, selection of this optional accessory also includes a lock-out function that prevents further automatic transfer operation until the appropriate source is manually reset. (Note: Supplied with Option 37A).

- 16B. Provides overcurrent protection on both power source supplies.
- 16N. Provides overcurrent protection on the normal power source supply only.

**23. Plant Exerciser (Standard)**

- 23G. This option allows for automatic testing of the generator at least once a week. Both load and no-load

testing can be selected. If the generator fails while in a load test, the transfer switch will return to the normal source only after a preprogrammed exerciser period has elapsed. **The plant exerciser is mounted on the intelligence panel and is marked PE (Figure 3-6).**

- 23J. This option allows for automatic testing of the generator at least once a week. Both load and no load testing can be selected. If the generator fails while in a load test the transfer switch will return to the normal power source automatically. **The plant exerciser is mounted on the intelligence panel and is marked PE.**

**26. Type of Protection (Normal Source)(Standard)**

All phase undervoltage protection is standard. A voltage sensing card monitors each phase of the normal power supply, and is normally set at 80% dropout and 90% pickup.

**26D. Remote Interruptible Utility Power (Standard)**

This option provides two terminal blocks for connection of a customer provided normally closed (NC) contact. When the NC contact is opened, the transfer switch initiates an engine start and will transfer the load to the emergency power source. Reclosing of a NC contact will initiate a retransfer back to the normal power source.

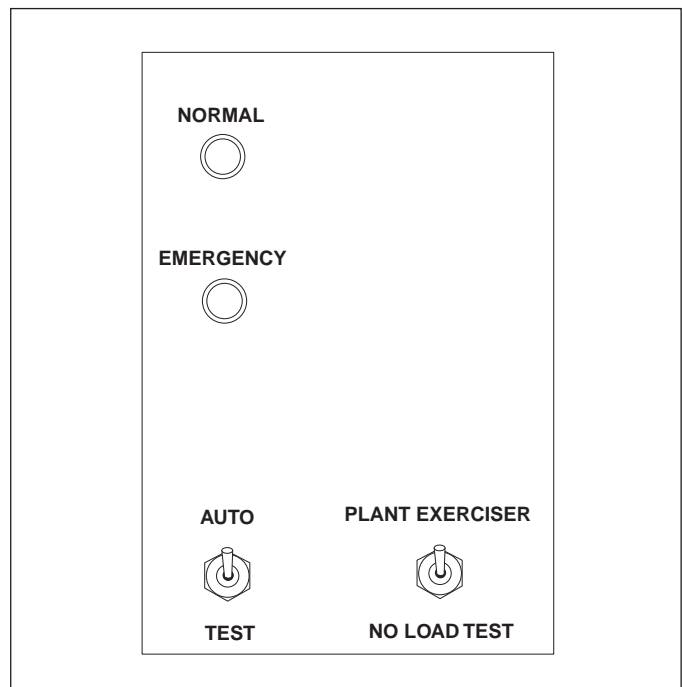

Figure 3-6 Device Panel on Front Cover



Figure 3-7 Typical Type 1 Enclosure (Door Closed)

**32A. Delayed Transition Timer (Time Delay Neutral) (Standard)**

Provides a time delay in the neutral (both OFF) position when the load is transferred in either direction to prevent excessive inrush currents due to out-of-phase switching of large motor loads. It utilizes a normally open auxiliary contact. Adjustment is from 0.5 to 60 seconds. **This option is labeled TDNL and is located above the transformer.**

**35A. Pre-Transfer Signal Device (Optional)**

Provides a set of two NO/NC form “C” contacts to allow loads to be de-energized prior to transfer in either direction. Typically used in conjunction with elevator controls. This option is labeled PSDR and PSDT.

The PSDR is located on the voltage selection panel and the PSDT is located on the transformer panel.

**3.6 ENCLOSURE**

The rugged steel switch enclosure is supplied with three door hinges, regardless of enclosure size, to ensure proper support of the door and door mounted devices (Figures 3-7 and 4-1). The hinges have removable hinge pins to facilitate door removal. Certain procedures, such as switch mounting, are simplified with the door removed. The doors are supplied as standard with a key-lockable handle.

The door is used to mount a variety of lights, switches and push-buttons, depending upon the options required for a particular switch. All switch doors are supplied with a metal accessory panel. All lights and switches are mounted in the metal door-mounted panel.

The rear of the enclosure is supplied with teardrop shaped holes in the top and bottom mounting flanges to facilitate mounting. It is also supplied with two positioning bolts and various pre-tapped inserts to insure proper positioning of the power panel anytime the power panel must be repositioned to accommodate a different cable entry position. Cable entry holes are the responsibility of the customer.

Transfer switch enclosures and all internal steel mounting plates, such as the power panel mounting plate, go through a pretreatment cleaning system prior to painting to ensure a durable finish.

The standard switch enclosure is NEMA Type 1 for general indoor use. A variety of enclosures are however, available to address almost any environmental circumstance (Table 3.1).

Table 3.1 Transfer Switch Equipment Enclosures

NEMA TYPE	DESIGN	PROTECTION
1	Indoor	Enclosed Equipment
3R	Outdoor	Rain, ice Formation
12	Indoor	Dust, Dirt and Non-Corrosive Liquids

### 3.7 STANDARDS

Cutler-Hammer transfer switch equipment enclosed in a NEMA 1 enclosure is listed for application by UL and UL-C. In addition, Cutler-Hammer automatic transfer switches are listed in File E38116 by Underwriters Laboratories, Inc. under Standard UL 1008. This standard covers requirements for automatic transfer switches intended for use in ordinary locations to provide lighting and power as follows:

- a. In emergency systems, in accordance with articles 517 and 700 in the National Electrical Code, ANSI/NFPA 70 and the National Fire Protection Association No. 76A and/or
- b. In standby systems, in accordance with article 702 of the National Electrical Code and/or
- c. In legally required standby systems in accordance with article 701 of the National Electrical Code.

Cutler-Hammer automatic transfer switches are available to meet NFPA110 for emergency and standby power systems, and NFPA99 for health care facilities when ordered with the appropriate options.

Since Cutler-Hammer automatic transfer switches use specially designed molded case switches as the main power switching contacts, these devices must also be listed under the additional UL Standards 1087. Underwriters Laboratories uses two basic types of listing programs - label service and reexamination.

UL1087 employs a label service listing program which requires an extensive follow-up testing program for listed devices. Standard UL1008 for automatic transfer switches lists devices under the reexamination program which only requires a continual physical reexamination of the components used in the product to ensure consistency with the originally submitted device. Follow-up testing *is not* required by UL1008.

Representative production samples of molded case switches and molded case circuit breakers used in Cutler-Hammer automatic transfer switches are subjected to a complete test program identical to the originally submitted devices on an ongoing periodic basis per UL1087. The frequency of such a re-submittal can be as often as every quarter for a low ampere device.

## SECTION 4: INSTALLATION AND WIRING

### 4.1 GENERAL

Transfer switches are factory wired and tested. Installation requires solidly mounting the enclosed unit and connecting power cables and auxiliary pilot circuits. Physical mounting procedures and power cable connections are covered in this section. All other required wiring or electrical connection references are covered in a separate Customer Wiring Booklet packed with the transfer switch. Locate the wiring booklet, review it, and keep it readily available for reference purposes during installation and testing. Once a transfer switch is properly installed and wired, it should be mechanically and electrically checked for proper installation and operation. The procedures for these initial mechanical and electrical checks are outlined in Section 6 of this instruction manual.

### NOTICE

To facilitate the procedures described in this section, the solid steel shield over the power panel should be removed. The shield is attached to the ratchet assembly with four screws. Remove the four screws and shield until the procedures are completed.



### WARNING

**BE CERTAIN THAT THE SOLID STEEL POWER PANEL SHIELD IS PROPERLY INSTALLED BEFORE TRANSFER SWITCH EQUIPMENT IS PUT INTO SERVICE. THE SHIELD PROVIDES PROTECTION FROM DANGEROUS VOLTAGES AT THE LINE AND LOAD TERMINALS WHEN THE EQUIPMENT IS IN OPERATION. FAILURE TO DO SO COULD RESULT IN PERSONAL INJURY OR DEATH.**

### 4.2 MOUNTING LOCATION

Choose a location that offers a flat, rigid mounting surface capable of supporting the weight of the enclosed transfer switch equipment (Figure 4-1). Avoid locations that are moist, hot, or dusty, however, there are enclosure designs available for special environments. If there are any doubts as to location suitability, discuss them with your Cutler-Hammer representative.

Check to make certain that there are no pipes, wires, or other mounting hazards in the immediate mounting area that could create a problem.

Carefully remove all packing material from the transfer switch at the mounting location. Even though an equipment inspection was made when the equipment was received, make another careful inspection of the enclosure and the enclosed transfer switch as packing material is removed and the enclosure readied for mounting. Be especially alert for distorted metal, loose wires or damaged components.

### 4.3 MOUNTING PROCEDURE



### CAUTION

**SINCE THE ENCLOSED TRANSFER SWITCH MUST BE LIFTED INTO PLACE FOR MOUNTING, BE CERTAIN THAT ADEQUATE RESOURCES ARE AVAILABLE FOR LIFTING TO AVOID PERSONNEL INJURIES OR EQUIPMENT DAMAGE.**

Refer to Figures 4-1 for enclosure and power panel mounting dimension references. All vertical design transfer switch equipment enclosures and power panels are of the same design. Only the overall physical dimensions change. Note in Figure 4-1 that the enclosure is provided with four elongated mounting holes, two in the top mounting flange and two in the bottom. Also notice that the power panel has two sets of mounting holes. One set positions the panel for top entry of cables and one set for bottom entry. This will be covered in more detail in Section 4.4

Transfer switch equipment is assembled and supplied as standard for top entry, although equally adaptable to bottom entry. Cable entry holes are not part of the enclosure when shipped from the factory and must be provided in the field, either before or after mounting the enclosure.



### CAUTION

**EXTREME CARE SHOULD BE TAKEN TO PROTECT THE TRANSFER SWITCH FROM DRILL CHIPS, FILINGS AND OTHER CONTAMINANTS WHEN MAKING THE CABLE ENTRY HOLES AND MOUNTING THE ENCLOSURE TO PREVENT COMPONENT DAMAGE OR A FUTURE MALFUNCTION.**

Power Panel Type	A	B	C	Weights
FD 30-200A	44" (1.18m)	21" (0.53m)	18.13" (0.47)	195 lbs (88kg)
KD 225A	44" (1.18m)	21" (0.53m)	19.63" (0.50m)	380 lbs (172kg)
KD 300A	52" (1.32m)	21" (0.53m)	19.63" (0.50m)	380 lbs (172kg)
LD 400A	61" (1.55m)	26" (0.66m)	20.63" (0.52m)	430 lbs (195kg)
MA 600A	73" (1.85m)	26" (0.66m)	20.63" (0.52m)	525 lbs (238kg)
NB/ND 800A	79" (2.01m)	26" (0.66m)	20.63" (0.52m)	610 lbs (275kg)

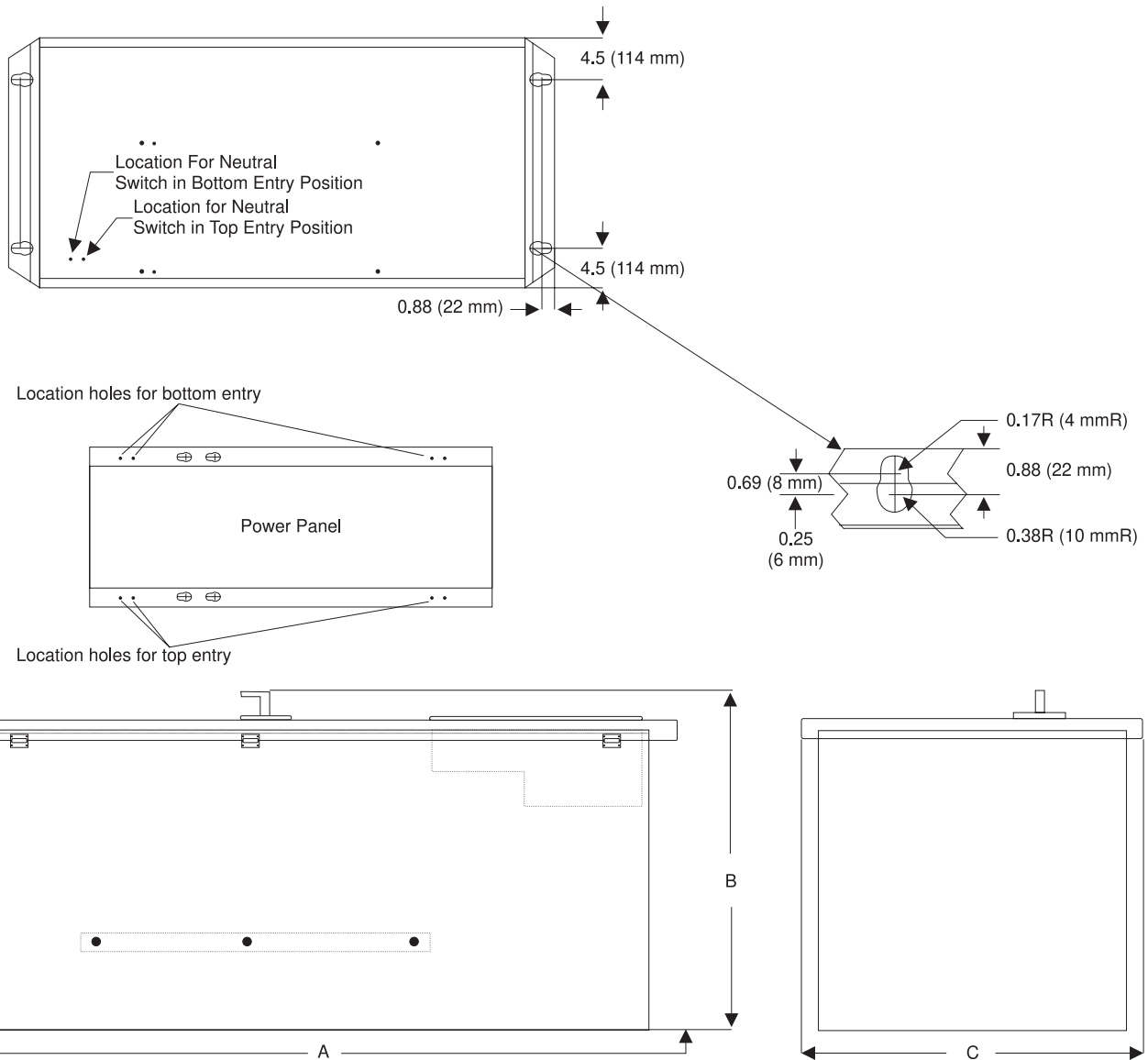

Figure 4-1 Dimensions of Enclosed Automatic Transfer Switch and Approximate Weights

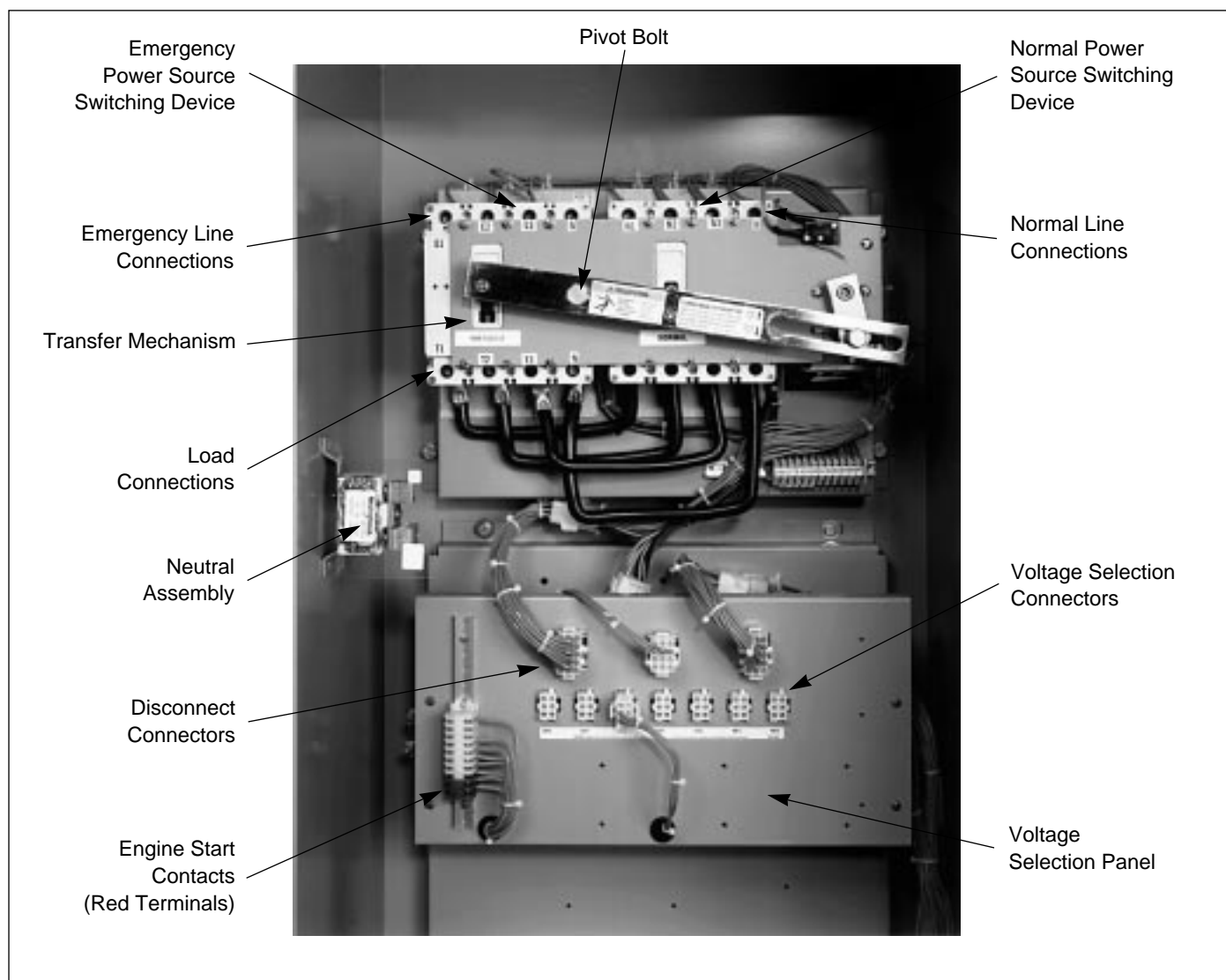

Figure 4-2 Typical (30-150 Amperes) Horizontal Design Transfer Switch Equipment (Door Open)

With the enclosed transfer switch equipment unpacked and ready for mounting, proceed with these steps:

**Step 1:** The transfer switch enclosure door is hinge mounted with removable hinge pins. To simplify the mounting procedure and avoid damaging the door-mounted logic panel, carefully remove the door and put it in a safe place until mounting is complete.

**Step 2:** Install required mounting bolt anchors and the two upper mounting bolts in the mounting surface.

**Step 3:** Gently lift the enclosure and guide the elongated holes in the upper mounting flange over the upper mounting bolts, but do not completely tighten the bolts.

**Step 4:** While still supporting the enclosure, install the two lower mounting bolts in the lower mounting flange, but do not completely tighten. Use shims, if required, to prevent deformation of the enclosure when the mounting surface is distorted.

**Step 5:** Tighten all four mounting bolts after any required shimming is completed.

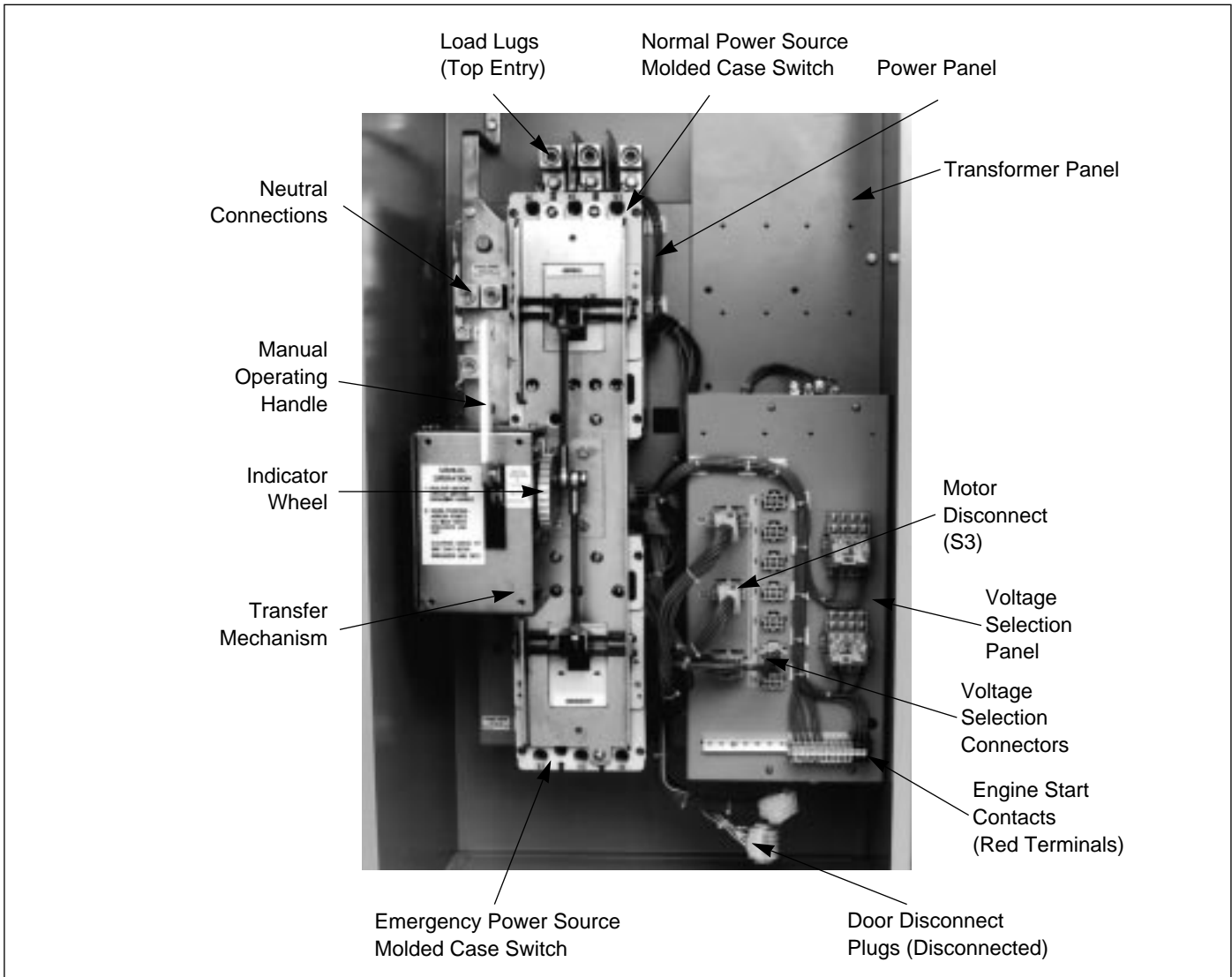

Figure 4-3 Typical (225-1000 Amperes) Vertical Design Transfer Switch Equipment (Door Open and Deadfront Shield Removed)

**Step 6:** Double check to ensure that all packing and shipping material has been removed.

**4.4 LOAD LUG LOCATION**

This section applies only to the 225-1000A switches. The load lugs for the 30-150A switch are fixed.

Transfer switch equipment is supplied as standard from the factory with load terminal lugs at the top. If the load lugs are to be repositioned to the bottom, do it at this time before wiring the unit or making power cable connections.



**WARNING**

**IF THE LOAD LUG LOCATION IS BEING CHANGED ON ALREADY INSTALLED TRANSFER SWITCH EQUIPMENT, MAKE SURE THAT THE NORMAL, EMERGENCY AND OTHER POWER SOURCES CONNECTED TO THE EQUIPMENT ARE DE-ENERGIZED. HAZARDOUS VOLTAGES ARE PRESENT INSIDE TRANSFER SWITCH EQUIPMENT AND CAN CAUSE SEVERE PERSONAL INJURY OR DEATH.**

With the solid steel shield removed, proceed with the following steps for bottom feed load termination.

- Step 1:** Disconnect the power panel from the rest of the transfer switch by unplugging the connector plugs (P1, P2, and P3) (Figures 4-3).
- Step 2:** Remove the bolt that bonds the neutral strap to the rear of the enclosure, if it is in place.
- Step 3:** Remove the four bolts that secure the power panel in the enclosure. Depending upon the size of the panel, it may be advisable to have assistance with the removal. Once the power panel is free, carefully move it to a solid work surface (Figure 3-3).

### NOTICE

**At this point, take the time to refer to Figure 4-1 and become familiar with the inside rear of the enclosure and the power panel mounting provisions available for both top and bottom entry. It will facilitate reinstallation of the power panel.**

- Step 4:** Remove the operating mechanism from the front of the power panel by removing the six bolts holding the mechanism in position. The molded case switches or optional circuit breakers do not have to be removed (Figure 3-3).

### NOTICE

**The rear-mounted load lugs, dip-insulated bus bars, standoff insulators, glass polyester phase barriers, and metal mounting bracket are designed to be removed as one load lug assembly (Figure 4-4).**

- Step 5:** The load lug assembly, just mentioned, is removed by first removing the six or eight bolts securing the pieces of insulated bus to the back of the power panel. The number of mounting bolts depends upon whether 3- or 4-pole devices are installed. Mounting bolts are accessed through holes in the load end of the molded case switches or optional circuit breakers.

- Step 6:** Next, remove the four bolts holding the mounting bracket to the upper rear portion of the power panel. The load lug assembly can now be removed as one unit. Note that there are grooves in the back of the power panel and in



Figure 4-4 Mounted Load Lug Assembly (225-1000A Models)

the mounting bracket that keep the polyester phase barriers in their proper positions.

- Step 7:** Turn the load lug assembly 180° with the lugs at the bottom and remount the assembly by reversing the procedures described in Steps 5 and 6. The mounting bracket will now be bolted to the bottom of the power panel. Make certain that all glass polyester phase barriers are in place and positioned properly in the grooves provided. When making any bolted connection to the bus, comply with the torque requirements as outlined in Table 4.1.

Table 4.1 Bolted Bus Connection Torque Requirements

Power Panel Switching Device	Torque ft-lb (Nm)
Type FD	10 (14)
Type KD	20 (27)
Type LD	25 (34)
Type MA	25 (34)
Type ND	25 (34)
Type NB	25 (34)

**Step 8:** Remount the operating mechanism to the front of the power panel with the six bolts removed previously in Step 4.

**Step 9:** Position the power panel in the enclosure such that the two upper elongated holes, one on either side of the power panel, fit over the two positioning bolts located in the rear of the enclosure. This will line up the four correct mounting holes in the power panel with the pre-tapped inserts in the rear of the enclosure.

**Step 10:** With the power panel held securely against the back of the enclosure, replace and tighten the four mounting bolts removed previously in Step 3.

**Step 11:** Attach the neutral strap to the back of the enclosure through the upper bonding hole, which may or may not have been previously removed in Step 2.

**Step 12:** Reconnect the connector plugs and the transfer switch equipment is now configured for bottom entry.

**4.5 POWER CABLE CONNECTIONS**



**WARNING**

**POWER CONDUCTORS MAY HAVE VOLTAGE PRESENT THAT CAN CAUSE SEVERE PERSONAL INJURY OR DEATH. DE-ENERGIZE ALL POWER OR CONTROL CIRCUIT CONDUCTORS TO BE CONNECTED TO THE TRANSFER SWITCH EQUIPMENT BEFORE BEGINNING TO WORK WITH THE CONDUCTORS AND/OR TERMINATING THEM TO THE EQUIPMENT.**



**CAUTION**

**USE OF CABLE LUGS NOT DESIGNED FOR THE TRANSFER SWITCH MAY CAUSE HEATING PROBLEMS. BREAKER LUGS ONLY MOUNT TO THE BREAKER, WHILE TRANSFER SWITCH LUGS MOUNT TO BOTH THE BREAKER AND THE BUS BAR BEHIND THE BREAKER. FOR INSTALLATION INSTRUCTIONS, REFER TO THE INSTRUCTION LEAFLET SUPPLIED FOR THE SPECIFIC LUGS.**



**CAUTION**

**TO HELP PREVENT COMPONENT DAMAGE OR FUTURE MALFUNCTIONS, USE EXTREME CARE TO KEEP CONTAMINANTS OUT OF THE TRANSFER SWITCH EQUIPMENT WHEN MAKING POWER CABLE CONNECTIONS.**



**CAUTION**

**RUN POWER CABLE THROUGH THE GUTTER SPACE PROVIDED TO THE RIGHT OF POWER PANEL. DO NOT ROUTE THE POWER CABLES BEHIND OR TO THE LEFT OF THE POWER PANEL. RUNNING THE CABLES BEHIND OR TO THE LEFT OF THE POWER PANEL COULD INTERFERE WITH THE PROPER OPERATION OF THE TRANSFER SWITCH.**

Test all power cables prior to connection to the unit to ensure that conductors or cable insulation have not been damaged while being pulled into position.

Power cables are to be connected to solderless screw type lugs located on the transfer switch switching devices. Refer to the separate Customer Wiring Booklet supplied with the transfer switch equipment for power termination. Verify that the lugs supplied will accommodate the power cables being used. Also verify that the cables comply with local electrical codes. Standard transfer switch equipment, as supplied from the factory, will accommodate the wire sizes shown in Table 4.2.

Carefully strip insulation from the power cables to avoid nicking or ringing of the conductor strands. Prepare the stripped conductor termination end by cleaning it with a wire brush. If aluminum conductors are used, apply an appropriate joint compound to the clean conductor surface area.

Table 4.2 Transfer Switch Equipment Wire Sizes

Transfer Switch Ampere Rating	Wire Size Ranges	Number of Cables per Phase
30-150	#14-3/0	1
200	#9-300MCM	1
225-300	#3-350MCM	1
400	250-350MCM	2
600 (3P)	#1-500MCM	2
600 (4P)	3/0-400MCM	3
800	3/0-500MCM	4



**WARNING**

**IMPROPER POWER CABLE CONNECTIONS CAN CAUSE EXCESSIVE HEAT AND SUBSEQUENT EQUIPMENT FAILURE.**

Tighten cable lugs to the torque identified on the label affixed to the unit immediately adjacent to the lugs.

**4.6 WIRING**



**WARNING**

**POWER CONDUCTORS AND CONTROL WIRING MAY HAVE VOLTAGE PRESENT THAT CAN CAUSE SEVERE PERSONAL INJURY OR DEATH. DE ENERGIZE ALL POWER OR CONTROL CIRCUIT CONDUCTORS BEFORE BEGINNING TO PERFORM ANY WIRING ACTIVITY TO OR WITHIN THE TRANSFER SWITCH EQUIPMENT.**

Power sources, load conductors and control wiring should be connected to locations as indicated in the Customer Wiring Booklet supplied with the transfer switch equipment.



**CAUTION**

**CHECK THE TRANSFER SWITCH EQUIPMENT NAMEPLATE FOR RATED VOLTAGE. IT SHOULD BE THE SAME AS THE NORMAL AND EMERGENCY LINE VOLTAGES. OPERATING THE EQUIPMENT ON IMPROPER VOLTAGE CAN CAUSE EQUIPMENT DAMAGE.**

Once the transfer switch equipment has been installed and wired, perform initial mechanical and electrical procedures as outlined in Section 6 to verify that the equipment is installed and operating properly.

**NOTICE**

**Remember to reattach the solid steel power panel shield to the ratchet assembly after completing any of the procedures described in this section.**

**4.7 ENGINE START CONNECTION**

The engine control contact connections are located on the logic panel of the ATS. Connect the engine start wires to the red terminal blocks marked 51 and 52. A contact closes between these terminal blocks when an engine start signal is provided by the ATS logic. The wiring diagram provides additional engine start connection information.

**NOTICE**

**Prior to making the engine start connection to the switch, set the engine generator controls selector switch in the OFF position to prevent an unwanted engine start.**

**4.8 VOLTAGE SELECTION ADJUSTMENTS**

Certain devices, such as the Voltage Selection Panel, sensing relays and timers, need to be set and/or calibrated prior to placing the transfer switch equipment into service. Adjustments for logic devices are described in the separate instructional document dedicated to the specific logic being used. Voltage selection adjustments are described here.



**CAUTION**

**BE SURE THAT THE CORRECT VOLTAGE IS SELECTED TO MATCH THE SYSTEM VOLTAGE. AN IMPROPER SELECTION AND/OR CONNECTION COULD RESULT IN EQUIPMENT DAMAGE.**

**Vertical Design Voltage Selection**

The vertical design transfer switch is furnished with a multi-tap Voltage Selection Panel to the right of the power panel. Seven front accessible taps from 208 to 600 volts AC are provided (Figure 3-4). A small discon-

nect plug is provided to change from one voltage to another.

#### ***Horizontal Design Voltage Selection***

Horizontal design transfer switches are furnished with an adjustable line voltage plug and receptacles below the power panel. To change the line voltage, remove the covers and insert the plug in the desired receptacle (Figure 4-5).

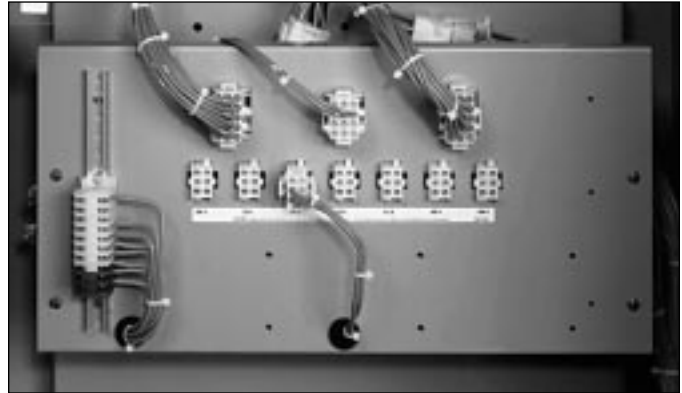

*Figure 4-5 Line Voltage Plug and Receptacles (shown with covers removed) for Horizontal Design*

## SECTION 5: OPERATION

### 5.1 GENERAL

A transfer switch provides main contacts to connect and disconnect the load to and from the normal and emergency power sources (Paragraph 3.2.2). Each transfer mechanism provides the mechanical motion required to open and close the mechanically interlocked main contacts (Paragraph 3.2.3).

Note that the transfer mechanisms for the two types of ATS described in this booklet (30-150A and 225-1000A) are different for both the manual and automatic modes.

### NOTICE

If a transfer switch with any type of electrical operating capabilities is to be operated utilizing the manual operating handle, it is strongly recommended that the transfer motor circuit first be isolated. This is accomplished by unplugging the (P3) plug marked motor disconnect (Figure 5-1). Any attempt to operate the manual handle without first isolating the motor circuit causes an automatic transfer.

### 5.2 MANUAL OPERATION (225-1000A)

The manual operating handle can be used to create the rotational motion required to open and close the main contacts through a rigid mechanical interlocking system (Figure 5-2). An indicator wheel attached to the operating handle and mechanical interlocking system rotates with each movement of the handle to open and/or close the main contacts (Figures 5-3). Three distinct switch positions are provided and indicated visually on the indicator wheel (Figure 5-4). The three distinct switch positions or contact conditions are:

- **Normal** - The contacts associated with the normal power source are closed and the emergency power source contacts are open.
- **Neutral** - The contacts associated with both the normal power source and emergency power source are open. This position allows for load circuit maintenance.
- **Emergency** - The contacts associated with the normal power source are open and the emergency power source contacts are closed.

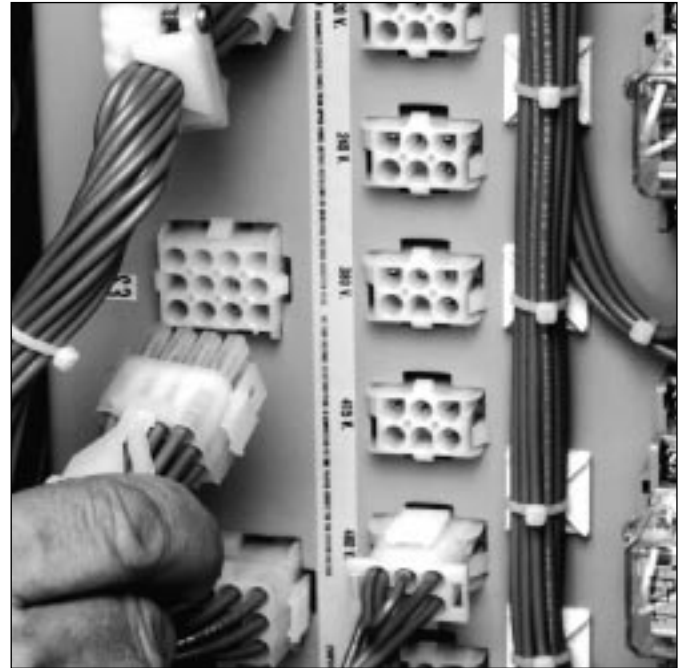

Figure 5-1 Motor Disconnect Being Unplugged



Figure 5-2 Transfer Switch Manual Operating Handle in Use (225-1000A Models)



Figure 5-3 Indicator Wheel Mounted in the Switch with Motor Under the Wheel (225-1000A Models)



Figure 5-4 Indicator Wheel in Neutral Position (225-1000A Models)

To manually operate the transfer switch, the operating handle is ratcheted until the desired switch position is indicated on the indicator wheel. The operating handle, no matter what design or type of switch operation, is always electrically "dead" and the indicator wheel free-wheels should a particular switch have a motor and be capable of electrical operation. This feature ensures no operator problems should the switch automatically operate while the manual handle is being used.

### 5.3 MANUAL OPERATION (30-150A)

To operate the switch manually, remove the pivot bolt (located between the two switches (Figure 4-2) using a 5/8-inch wrench or socket. Lift the lever off the two switches (Figure 5-5), which can then be operated manually (Figure 5-6). The switches are mechanically interlocked so that only one can be in the ON position at any one time, but both can be in the OFF position at the same time.

### 5.4 AUTOMATIC TRANSFER

The operating sequence of an automatic transfer switch is dictated by the switch's standard features and selected options. Operation of an automatic transfer switch during normal source failure and normal source restoration will be described here with only standard options included on the switch. Additional options, as described in Section 3, can change sequences and timing, depending upon the options selected. Become familiar with additional options selected and their effect on the normal operation of an automatic transfer switch.

#### 5.4.1 NORMAL POWER SOURCE FAILURE

Standard normal source failure is defined as a reduction or loss of voltage. If this occurs, the sequence of operation is as follows:

- Failure of the normal source is detected by the micro-processor intelligence.
- When the microprocessor detects a failure, the normal relay drops out, opening certain contacts while closing others. One of the contacts starts the engine-driven generator.
- When the emergency source voltage reaches its operation rating, an emergency relay closes, starting the transfer operation. This operating sequence opens the normal switch and closes the emergency switch.
- The load is now transferred to emergency source.

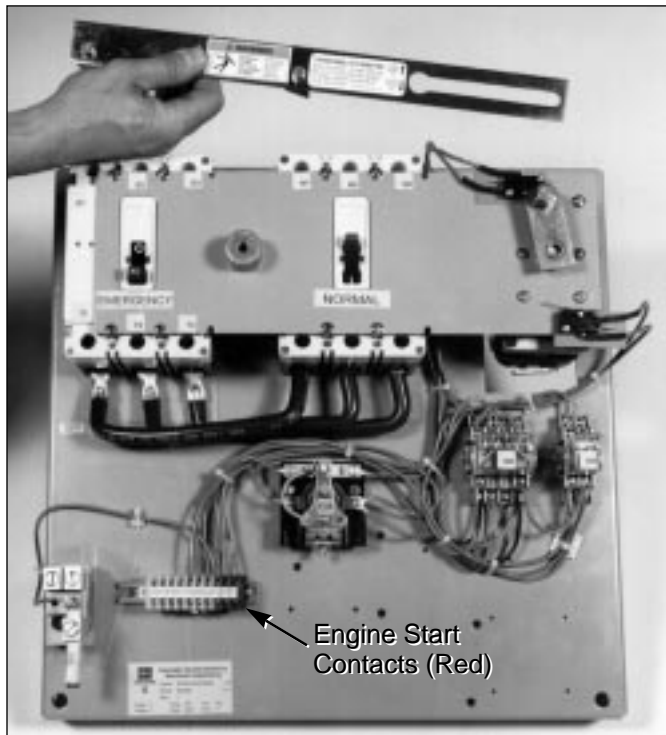

Figure 5-5 Transfer Mechanism with Lever Removed (30-150A Model)

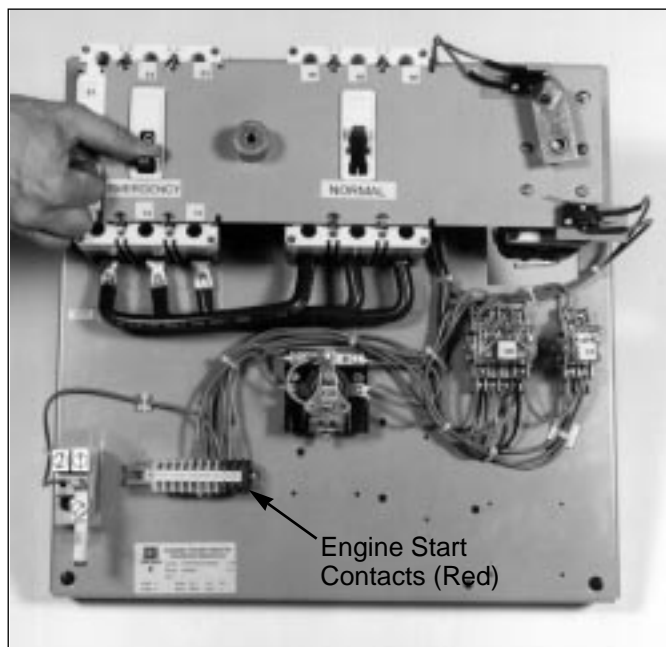

Figure 5-6 Switch Being Manually Operated (30-150A Model)

#### 5.4.2 NORMAL POWER SOURCE RESTORATION

- A return to the normal power source begins when the voltage in all phases of a three-phase sensing unit or phase-to-phase in a single sensing unit is restored to a present value.
- At the present voltage, the microprocessor will cause the normal relay to pickup.
- The normal relay closes certain contacts while opening others. This starts the return to the normal power source and normal transfer switch operation.
- During this sequence, the emergency power source switch is opened and the normal power source switch is closed.
- Simultaneously, the engine cool-down relay initiates the shut down of the engine driven generator.
- Transfer of the load back to the normal power source is now complete.

## SECTION 6: TESTING AND PROBLEM SOLVING

### 6.1 TESTING

After the transfer switch equipment is initially installed or during planned outages, the installation should be tested to ensure that all equipment operates properly. This attention to detail will help to avoid unexpected malfunctions. Mechanical and/or electrical tests should be performed as described in this section.

The frequency of subsequent testing should be based on recommendations of the generator set manufacturer. Use the test switch to check the electrical operation of the switch. **ALWAYS RETURN THE SWITCH TO THE AUTO POSITION AFTER THE TEST IS COMPLETE.**



### WARNING

**HIGH VOLTAGES ASSOCIATED WITH OPERATIONAL TRANSFER SWITCH EQUIPMENT PRESENT A SHOCK HAZARD THAT CAN CAUSE SEVERE PERSONAL INJURY OR DEATH. USE EXTREME CAUTION TO AVOID TOUCHING ELECTRICAL CONNECTIONS WHENEVER INSPECTING OR TESTING THE EQUIPMENT.**

**IN ADDITION, IMPROPER OPERATION OF THE GENERATOR SET PRESENTS A HAZARD THAT CAN CAUSE SEVERE PERSONAL INJURY OR DEATH. OBSERVE ALL SAFETY PRECAUTIONS IN YOUR GENERATOR SET OPERATIONS AND INSTALLATION MANUALS.**

#### 6.1.1 MECHANICAL AND/OR ELECTRICAL TESTING

### NOTICE

Since Option 4 (Time Delay Engine Cool-Off) as described in Section 3 is standard, an engine start signal will be present for a period of time when the switch is first energized. The period of time is equal to the timer setting. To avoid starting the engine during this time period, turn the generator controls to the OFF position.

Energize the transfer switch equipment as described in Paragraphs 6.1.2 through 6.1.6. Insure that all safety precautions are taken and that all WARNINGS and CAUTIONS are observed.

#### 6.1.2 NO VOLTAGE STEPS

With no voltage available on either power source, proceed as follows:

- Step 1:** Check to make sure that both the normal and emergency power switching devices are in the OPEN position. The switching devices can be put into the OPEN position by use of the manual operator and stopping in the NEUTRAL position.
- Step 2:** Check to make sure the test selector switch, provided, is in the AUTO position.
- Step 3:** The generator engine start controls should be in the OFF position to prevent an undesired start.
- Step 4:** Preset all timing circuits in keeping with timing instructions as outlined in Section 7.
- Step 5:** Check all transfer switch loads to ensure that they are ready to be energized.

#### 6.1.3 CONNECTING POWER SOURCES

- Step 1:** Close the normal power source upstream protection device.
  - a) The normal power switching device should close.
- Step 2:** Connect the engine start battery cable.
- Step 3:** With the emergency generator in the OFF position close the emergency power source upstream protective device, assuming such a device used.

### NOTICE

**At this point and prior to making any attempt to energize the transfer switch equipment, the engine-driven generator should be operated. If necessary, the voltage regulator on the generator should be adjusted according to the manufacturer's recommendations. The automatic transfer switch equipment will respond only to the rated voltage and frequency indicated. on the switch rating nameplate.**

- Step 4:** Reclose any generator engine-start controls opened as a result of actions taken in Step 4, Paragraph 6.1.2

**Step 5:** Where required, use an accurate voltmeter to check phase-to-phase and phase-to-neutral voltages present at the transfer switch normal, emergency, and/or load terminals.

#### 6.1.4 OPERATIONAL CHECKS

**Step 1:** Check to ensure that the normal switching device is in the CLOSED position. This should have been done in Step 1a Paragraph 6.1.3.

**Step 2:** Initiate an automatic transfer operation from the normal to emergency power source by moving the test selector switch from the AUTO to the TEST position.

- a) After the Time Delay Enging Starting (TDES) has timed out, the engine should start, run, and build up to normal voltage and frequency.
- b) The transfer switch will transfer to the emergency power source (normal switching device opens and emergency switching device closes) after the Time Delay Normal to Emergency (TDNE) times out.

**Step 3:** Initiate an automatic transfer operation back to the normal power source by moving the test selector switch from the TEST to the AUTO position.

- a) After the Time Delay Emergency to Normal timer (TDEN) has timed out, the transfer switch will transfer back to the normal power source (emergency switching device opens and normal switching device closes).
- b) The Time Delay for Engine Cool-Off (TDEC) option will allow the engine to run unloaded for a preset time after transfer to normal power source is completed.

#### 6.1.5 ALTERNATE TESTS

1. Alternate operational tests may be possible depending upon the options provided with any given transfer switch. Refer to the schematic diagram provided with the transfer switch equipment along with the specification nameplate to determine the exact options provided.
2. If the transfer switch is operated manually with the normal power source connected and available, it will cycle back to normal power source, since it is the preferred source. The transfer switch is designed for

safe manual transfer if an automatic transfer is initiated during the manual transfer.

## 6.2 PROBLEM SOLVING



### WARNING

**HAZARDOUS VOLTAGES IN AND AROUND TRANSFER SWITCH EQUIPMENT DURING THE PROBLEM SOLVING PROCESS CAN CAUSE PERSONAL INJURY AND/OR DEATH. AVOID CONTACT WITH ANY VOLTAGE SOURCE WHILE PROBLEM SOLVING.**



### WARNING

**ONLY PROPERLY TRAINED PERSONNEL FAMILIAR WITH THE TRANSFER SWITCH EQUIPMENT AND ITS ASSOCIATED EQUIPMENT SHOULD BE PERMITTED TO PERFORM THE PROBLEM SOLVING FUNCTION. IF AN INDIVIDUAL DOES NOT FEEL QUALIFIED TO PERFORM THE PROBLEM SOLVING FUNCTION, THE INDIVIDUAL SHOULD NOT ATTEMPT TO ANY OF THESE PROCEDURES.**

A basic problem-solving effort is the first step to take prior to calling for assistance. Frequently, the effort will successfully address most problems encountered. The problem solving procedure is presented in the following paragraphs as observed problem symptoms and one or more possible solution steps. Remember, only qualified individuals familiar with the transfer switch equipment and the system in which it is applied should attempt these problem solving procedures.

If a problem persists after having completed the problem-solving procedure, contact a Cutler-Hammer representative for further assistance. When calling for assistance, the following is the minimum information required to properly address the need:

1. Style Number of transfer switch
2. Catalog Number of transfer switch
3. Actual location of transfer switch (type of facility, address etc.)
4. Company name Name and position of individual representing company
5. Basic description of situation as it exists

6. Any results of problem solving steps taken and/or readings taken

### 6.2.1 TRANSFER SWITCH APPEARS INOPERATIVE

- Step 1:** Verify that all plugs and sockets are properly interconnected
- Step 2:** Verify that the correct system voltage is correct by measuring the voltage at the line side of the normal switching device.
- Step 3:** Verify that the voltage selection plug is in the proper position to match the system voltage.
- Step 4:** Look for any obviously burned components. Determine the cause and rectify, if possible. Replace defective components after the cause is determined.
- Step 5:** Manually ratchet the operating handle to the NORMAL position. Verify whether or not the system voltage now appears on the load terminals.
- If YES: Proceed to check logic for problems.
- If NO: Check all power connections and the switching mechanism.

### 6.2.2 MOTOR KEEPS TURNING AND TRANSFER SWITCH WILL NOT STOP IN POSITION

- Step 1:** Check the appropriate limit switch (normal or emergency). The normal limit switch (NLS) should open with normal switch closed and emergency limit switch (ELS) should open with emergency switch closed

### 6.2.3 TRANSFER SWITCH WILL NOT AUTOMATICALLY TRANSFER TO NORMAL

- Step 1:** Are the correct line voltage and frequency available at terminals N1, N2, N3 and N4? Record reading.
- If YES: Proceed to Step 2.
- If NO: Check source.
- Step 2:** Is the voltage selector plug in the correct position?
- If YES: Proceed to Step 3.
- If NO: Position plug correctly.

- Step 3:** Is the test switch in the TEST position?

If YES: Move switch to AUTO.

If NO: Proceed to Step 4.

- Step 4:** Check the voltage on microprocessor logic connector P1, terminals 1 and 2 using an AC voltmeter. The voltage should measure 24 VAC  $\pm 1$  volt. Record reading.

If YES: Proceed to Step 5.

If NO: Measure voltage on Transformer NT1X1, and X2. Voltage should measure 120 VAC  $\pm 10$  volts. Record reading.

If NO: Check NT1.

If YES: Measure voltage from Transformer NT1 X1 to Terminal Block 59 and 60. Voltage should be 120 VAC  $\pm 10$  volts.

If YES: Check NT2.

If NO: Check jumpers and options installed between terminals 59 and 60. (PE, Test Switch, etc..)

- Step 5:** Check the voltage on microprocessor logic connector P1, terminals 4 and 5 using an AC voltmeter. The voltage should measure 12 VAC  $\pm 0.5$  volts. Record reading.

If YES: Proceed to Step 6.

If NO: Check NT3.

- Step 6:** Check the voltage on microprocessor logic connector P1, terminals 6 and 7 using an AC voltmeter. The voltage should measure 12 VAC  $\pm 0.5$  volts. Record reading.

If YES: Proceed to Step 7.

If NO: Check NT4.

- Step 7:** Is normal voltage LED illuminated?

If YES: Proceed to Step 8.

If NO: Verify board is properly programmed. Replace board if necessary.

- Step 8:** Is the TDEN or LED illuminated?

If YES: Proceed to Step 9.

If NO: Check board.

**Step 9:** Check the voltage from NT1 X4 to Terminal 23 on the microprocessor logic connector P1. Is it 120 VAC  $\pm$ 10 volts?

If YES: Proceed to Step 10.

If NO: Check normal limit switch (NLS).

**Step 10:** Check the voltage from Terminal 20 to 24. Is it 120 VAC  $\pm$ 10 volts?

If YES: Check motor and bridge rectifier.

If NO: Check normal relay (NR).

**Step 11:** Contact Cutler-Hammer.

#### 6.2.4 TRANSFER SWITCH WILL NOT AUTOMATICALLY TRANSFER TO EMERGENCY

**Step 1:** If the alternate source is a generator, is it running?

If YES: Proceed to Step 2.

If NO: Check generator. Check engine start contact.

**Step 2:** Is the correct line voltage AND frequency available at terminals E1, E2, E3 and E4? Record reading.

If YES: Proceed to Step 3.

If NO: Make sure generator breaker is closed. Verify there is output voltage from generator.

**Step 3:** Is the voltage selector plug in the correct position?

If YES: Proceed to Step 4.

If NO: Position plug correctly.

**Step 4:** Is the normal source available?

If YES: Is a test (either manual or exercise) being run?

If YES: Proceed to Step 5.

If NO: STOP! Transfer switch SHOULD NOT transfer to emergency.

If NO: Proceed to Step 5.

**Step 5:** Check the voltage on microprocessor logic connector P1, terminals 8 and 10 using an AC voltmeter. The voltage should measure 24 VAC  $\pm$ 1 volt. Record reading.

If YES: Proceed to Step 6.

If NO: Measure voltage on Transformer ET1X1, and X2. Voltage should measure 120 VAC  $\pm$ 10 volts. Record reading.

If NO: Check ET1.

If YES: Measure voltage from Transformer ET1X1 to Terminal Block 61. Voltage should be 120 VAC  $\pm$ 10 volts.

If YES: Check ET2.

If NO: Check jumpers and options installed between Terminals 61 and 62.

**Step 6:** Are emergency voltage or frequency LED illuminated?

If YES: Proceed to Step 9.

If NO: Check board.

**Step 7:** Is the TDNE LED illuminated.

If YES: Proceed to Step 10.

If NO: Is TDEN (Time Delay Emergency to Normal) LED illuminated?

If YES: STOP! ATS should not be in emergency.

If NO: Check board.

**Step 8:** Check the voltage from ET1X4 to Terminal 14. Is it 120 VAC  $\pm$ 10 volts? Record reading.

If YES: Proceed to Step 11.

If NO: Test emergency relay (ER).

**Step 9:** Check the voltage from ET1X3 to Terminal 15 on the microprocessor logic connector P1. Is it 120 VAC  $\pm$ 10 volts? Record reading.

If YES: Proceed to Step 12.

If NO: Check emergency limit switch (ELS) in the emergency switch.

**Step 10:** Check the voltage from Terminal 19 to Terminal 24. Is it 120 VAC  $\pm$ 10 volts? Record reading.

If YES: Proceed to Step 13.

If NO: Test normal relay (NR).

**Step 11:** Contact Cutler-Hammer for additional assistance.

## SECTION 7: ADJUSTMENTS

### 7.1 GENERAL

Certain devices, such as the sensing relays and timers, need to be set and/or calibrated prior to placing the transfer switch equipment into service. The devices furnished with the equipment will be the same or similar to those described in this section. Adjustments should be made as instructed for the devices supplied.

### 7.2 PLANT EXERCISER TIMER

The plant exerciser is a 7-day timer switch used to exercise the engine driven generator.

#### 7.2.1 TIMER PROGRAMMING

The timer incorporates a 7-day time base, permitting each day of the week to be uniquely programmed (Figure 7-1). For convenience, block programming is also provided. This allows up to seven days to be grouped together if the ON and OFF times are the same. The timer displays in AM/PM format. When setting the hours, attention must be given to whether it is AM or PM.



Figure 7-1 Plant Exerciser Timer

## NOTICE

**After power-up, press the reset button before setting the time or programming. This will clear the memory of all data from testing and handling.**

### 7.3 MICROPROCESSOR-BASED LOGIC

There are four main groups of functions included in the AGswitch controller (Figure 7-2).

#### 7.3.1 VOLTAGE SENSING FUNCTIONS

**Volt sensing functions are factory programmed**

- 1-phase or 3-phase sensing
- Undervoltage sensing

Dip switches are used to select the pickup and dropout points for normal undervoltage and emergency undervoltage.

##### *Undervoltage Sensing Function*

- Available pickup settings (% of normal): 100, 95, 90, and 85
- Available dropout settings (% from pickup setting): 5, 10, 15, and 20.

#### 7.3.2 FREQUENCY SENSING FUNCTIONS

**The controller is factory programmed to sense underfrequency of the emergency power source only.**

Dip switches are used to select the normal frequency of the power sources and the pickup points.

The normal frequency settings are 50 or 60 Hz. The dropout points are fixed at 2 Hz differential. Available pickup settings for the under frequency function are:

- at 60 Hz nominal = 56, 57, 58, 59 Hz
- at 50 Hz nominal = 46, 47, 48, 49 Hz

#### 7.3.3 TIME DELAY FUNCTIONS

The controller is factory programmed to include different time delay functions. Each function has different timing ranges that can be adjusted by moving the appropriate dip switches or jumper.

**TDNE, TDEN, and TDEC (Dip Switches)**

- 0.1 sec. to 60 sec.
- 10 sec. to 10 min.
- 1 min. to 60 min.
- 3 min. to 200 min.

**TDES (Jumper)**

- 0-20 (jumper on)
- 20-40 (jumper off)

Both the pickup and dropout values of the sensing function and the timing ranges of the time delay functions may be easily changed by following the instructions provided in the later sections.

Controllers shipped from the factory are programmed to the user's original specification or to the standard pickup and dropout values as follows:

Function	Pickup	Dropout
Undervoltage 90%	80%	
Underfrequency (60 Hz)	58 Hz	56 Hz
Underfrequency (50 Hz)	48 Hz	46 Hz

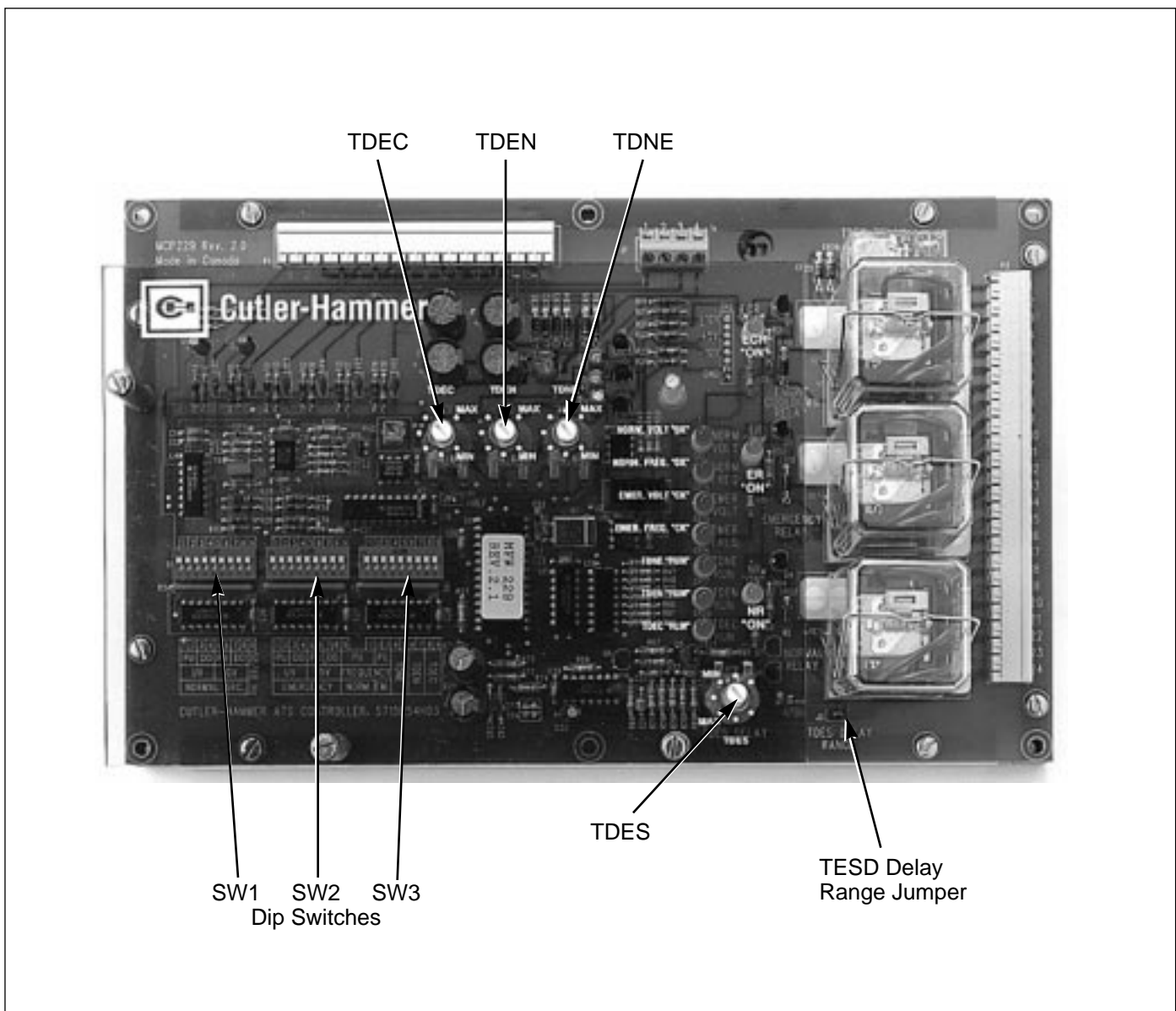

Figure 7-2 Genswitch Microprocessor-based Logic Control Panel

**7.3.4 ON-BOARD INDICATORS**

Ten LED indicators are installed on the controller's circuit board for the following functions:

Norm Volt	LED ON indicates the voltage level of the normal source is within present limits.
Norm Freq	LED OFF indicates the normal frequency sensing option is not installed.
Emer. Volt	LED ON indicates the voltage level of the emergency source in within preset limits.
Emerg. Freq.	LED ON indicates the frequency of the emergency source is within preset limits.  LED Flashes indicate the frequency of the emergency source is out of preset limits.  LED OFF indicates the emergency frequency sensing option is not installed.
TDNE RUN	LED flashes indicate TDNE time delay function is in progress.
TDEN RUN	LED flashed indicate TDEN time delay function is in progress.
TDEC RUN	LED flashes indicate TDEC time delay function is in progress.
NR ON	LED ON indicates the normal relay is energized.
ER ON	LED ON indicates the emergency relay is energized.
ECR ON	LED ON indicates the engine cooldown relay is energized.



**WARNING**

**IF THE CONTROLLER IS TO BE USED FOR THREE-PHASE SENSING, YOU MUST INSURE THAT THE SENSING SIGNALS (NORMAL OR EMERGENCY) ARE FED BY A THREE-PHASE TRANSFORMER PACKAGE. ON THE CUTLER-HAMMER BRAND THREE-PHASE UNITS SOLD BY CUTLER-HAMMER, THE STANDARD IS THREE PHASE SENSING ON NORMAL, AND SINGLE-PHASE SENSING ON EMERGENCY.**

**7.3.5 INSTRUCTIONS FOR DIP SWITCH SETTING**

The DIP switches located and accessed from the bottom-left portion of the control board must be properly set according to application requirements. The three DIP switches are labeled from left to right (Figure 7-2) as SW1, SW2, and SW3. All switches are turned ON or OFF by sliding the switch. As you face the DIP switches, slide:

- To the top to turn the switch ON
- To the bottom to turn the switch OFF

Always look for the ON and OFF designations on the hardware or printed circuit board to be sure you are setting the switches correctly.

Table 7.1 shows the selection grouping that can be provided by the three DIP switches.

*Table 7.1 Selection Grouping for DIP Switches*

DIP Switch	Side Switch	Description
SW1	1	Pickup and Dropout values for the Normal Source UNDERVOLTAGE SENSING. Refer to Table 7.2.
	2	
	3	
	4	
	9	Line Frequency selection ON = 60 Hz, OFF=50 Hz
SW2	1	Pickup and Dropout values for the Emergency Source UNDERVOLTAGE SENSING. Refer to Table 7.2.
	2	
	3	
	4	
	2	Pickup and Dropout value selection for the Emergency Source. Underfrequency and/or Overfrequency sensing. Refer to Table 7.4.
3		
SW3	4	Delay Timing Ranges Selection for TDNE function. Refer to Table 7.5.
	5	
	6	Delay Timing Ranges selection for TDNE function. Refer to Table 7.6.
7		
	8	Delay Timing Ranges selection for TDEC function. Refer to Table 7.7.
9		

**Table 7.2 Parameters for Programming Undervoltage Pickup and Dropout for Normal Power Source**

Pickup (%)	Dropout (%)	SW1-1	SW1-2	SW1-3	SW1-4
100	95	ON	ON	ON	ON
	90	ON	ON	OFF	ON
	85	ON	ON	ON	OFF
	80	ON	ON	OFF	OFF
95	90	OFF	ON	ON	ON
	85	OFF	ON	OFF	ON
	80	OFF	ON	ON	OFF
	75	OFF	ON	OFF	OFF
90	85	ON	OFF	ON	ON
	80	ON	OFF	OFF	ON
	75	ON	OFF	ON	OFF
	70	ON	OFF	OFF	OFF
85	80	OFF	OFF	ON	ON
	75	OFF	OFF	OFF	ON
	70	OFF	OFF	ON	OFF
	65	OFF	OFF	OFF	OFF

**Table 7.3 Parameters for Programming Undervoltage Pickup and Dropout for Emergency Power Source**

Pickup (%)	Dropout (%)	SW2-1	SW2-2	SW2-3	SW2-4
100	95	ON	ON	ON	ON
	90	ON	ON	OFF	ON
	85	ON	ON	ON	OFF
	80	ON	ON	OFF	OFF
95	90	OFF	ON	ON	ON
	85	OFF	ON	OFF	ON
	80	OFF	ON	ON	OFF
	75	OFF	ON	OFF	OFF
90	85	ON	OFF	ON	ON
	80	ON	OFF	OFF	ON
	75	ON	OFF	ON	OFF
	70	ON	OFF	OFF	OFF
85	80	OFF	OFF	ON	ON
	75	OFF	OFF	OFF	ON
	70	OFF	OFF	ON	OFF
	65	OFF	OFF	OFF	OFF

**Table 7.4 Parameters for Programming Underfrequency Pickup and Dropout for Emergency Power Source**

Pickup (%)	Dropout (%)	SW3-2	SW3-3
59	57	ON	ON
58	56	OFF	ON
57	55	ON	OFF
56	54	OFF	OFF
49	47	ON	ON
48	46	OFF	ON
47	45	ON	OFF
46	44	OFF	OFF

**Table 7.5 Range Selection for Time Delay Normal to Emergency (TDNE)**

Range	SW3-4	SW3-5
0.10 sec. to 60 sec.	ON	ON
0.16 min. to 10 min.	OFF	ON
1.00 min. to 60 min.	ON	OFF
3.00 min. to 200 min.	OFF	OFF

**Table 7.6 Range Selection for Time Delay Emergency to Normal (TDEN)**

Range	SW3-6	SW3-7
0.10 sec. to 60 sec.	ON	ON
0.16 min. to 10 min.	OFF	ON
1.00 min. to 60 min.	ON	OFF
3.00 min. to 200 min.	OFF	OFF

**Table 7.7 Range Selection for Time Delay Engine Cool Down (TDEC)**

Range	SW3-8	SW3-9
0.10 sec. to 60 sec.	ON	ON
0.16 min. to 10 min.	OFF	ON
1.00 min. to 60 min.	ON	OFF
3.00 min. to 200 min.	OFF	OFF

*Table 7.8 This Table Serves as a Quick Reference for Finding the Actual Voltage Level that Relates to the Percentage of the Normal System Voltage*

	120	208	220	240	380	400	415	480	600	
65%	78	135	143	156	247	260	270	336	390	
70%	84	146	154	168	266	280	291	336	420	
75%	90	156	165	180	285	300	311	360	450	
80%	96	166	176	192	304	320	332	384	480	Std. UV Pickup
85%	102	177	187	204	323	340	353	408	510	
90%	108	187	198	216	342	360	374	432	540	Std. UV Pickup
95%	114	198	209	228	361	380	394	456	570	
100%	120	208	220	240	380	400	415	480	600	

## SECTION 8: MAINTENANCE

### 8.1 INTRODUCTION

**HIGH VOLTAGES ARE PRESENT IN AND AROUND TRANSFER SWITCH EQUIPMENT. BEFORE INSPECTING OR MAINTAINING THIS EQUIPMENT, DISCONNECTING LINE POWER FROM THE LOCKING OUT, IF POSSIBLE, THE NEXT HIGHEST DISCONNECT DEVICE. FAILURE TO FOLLOW THIS PROCEDURE COULD CAUSE PERSONAL INJURY AND/OR DEATH.**

In general, transfer switch equipment is designed to be relatively maintenance free under normal usage. However, because of the variability of application conditions and the importance placed on dependable operation by this type of equipment, inspection and maintenance checks should be made on a regularly scheduled basis. Since equipment maintenance will consist mainly of keeping the equipment clean, the frequency of main-

tenance will depend to a large extent on the cleanliness of the surrounding. If a significant amount of dust or foreign matter is present, a more frequent maintenance schedule should be followed.

It is suggested that visual inspections of the equipment be made on a regular basis, not just during scheduled periods. Always be alert for an accumulation of dirt in and around the structure; loose parts and/or hardware; cracks and/or discoloration to insulation; and damaged or discolored components.

Figure 8-1 is the wiring diagram for the Genswitch automatic transfer switch. Only qualified and experienced personnel should attempt any diagnostic work using this diagram.

### 8.2 PROCEDURES

A suggested maintenance procedure to follow is outlined in Table 8.1.

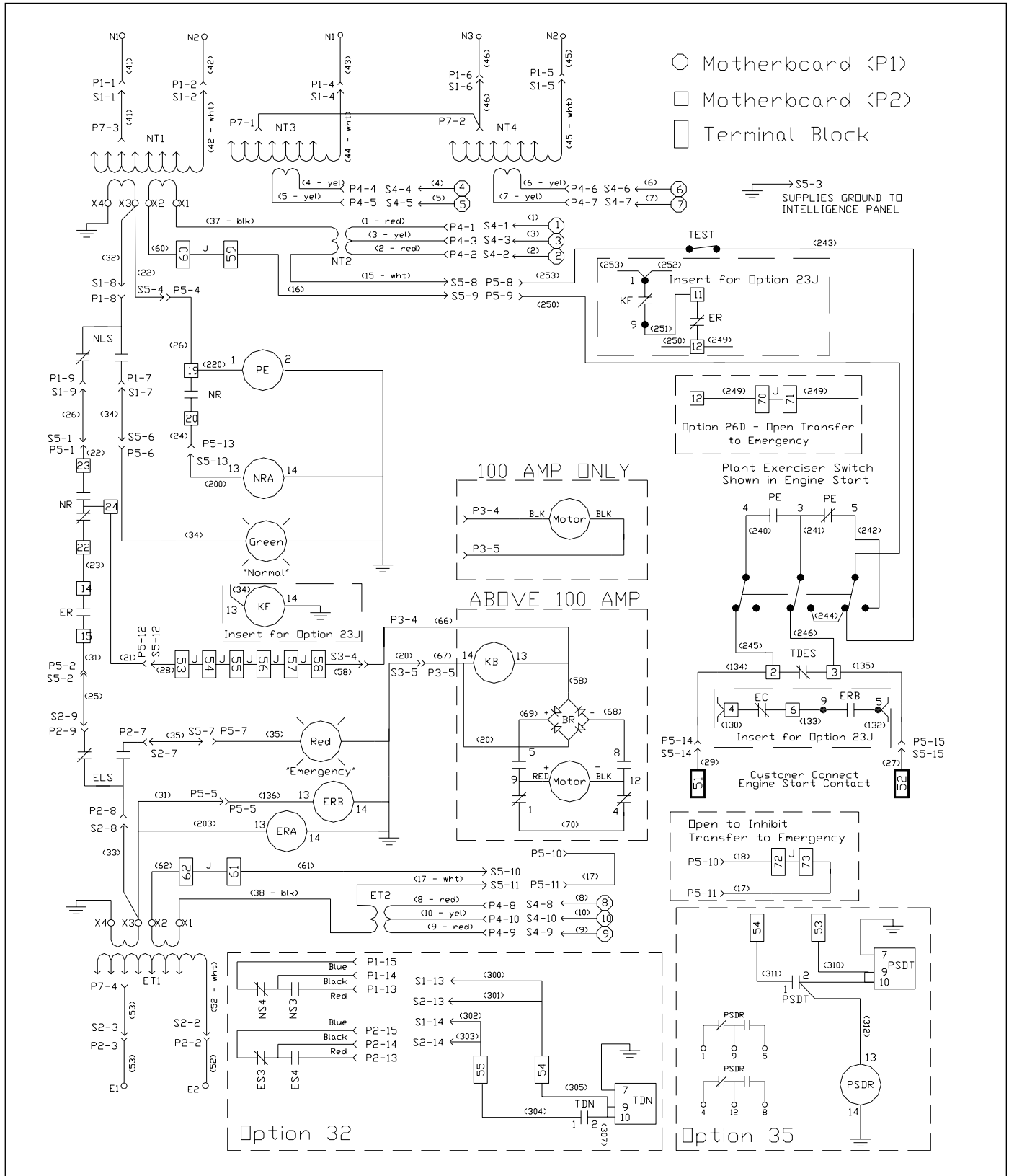

Figure 8-1 Wiring Diagram for AGswitch Automatic Transfer Switch

Table 8.1 Periodic Maintenance Procedures

Step	Action
a. Make transfer switch equipment safe for inspection and/or maintenance.	Disconnect line power from equipment being serviced by opening next highest disconnect device. Make certain that any accessory control power is switched off by disconnecting all control plugs.
b. Inspect structure area for safety hazards or potential maintenance problems.	<p>Inspect area, especially where molded case switching devices are installed, for any safety hazards, including personnel safety and fire hazards. Exposure to certain chemical vapors can cause deterioration of electrical connections.</p> <p>Inspect for accumulated dirt, loose hardware or physical damage.</p> <p>Examine primary insulation for evidence of cracking or overheating. Overheating will show as discoloration, melting, or blistering of conductor insulation, or as pitting or melting of conductor surfaces due to arcing.</p> <p>Inspect secondary control connections for damage, and control wiring for insulation integrity.</p>
c. Inspect molded case switching devices for dust, dirt, soot, grease, moisture or corrosion.	Remove dust, dirt, soot, grease, moisture and corrosion contamination from the surface of the switching device using a dry soft lint-free cloth, dry soft bristle brush and vacuum cleaner. Do not blow debris into circuit breaker or nearby breaker structure. If contamination is found, look for the source and fix the problem.
d. Check for material integrity, uneven wear, discoloration or loose hardware.	Severe material cracking will require replacement and loose hardware will need to be tightened.
e. Check terminals and connectors for looseness or signs of overheating.	<p>Overheating will show as discoloration, melting, or blistering of conductor insulation.</p> <p>Connections that do not have signs of looseness or overheating should not be disturbed.</p>
f. Exercise the molded case switching devices if they are not often exercised while in operation. This will permit wiping action by the contacts.	If a switching device is used for frequent switching during normal operation, this step can be disregarded.
g. Return transfer switch equipment to service.	Make certain all barriers are in place and doors closed. Re-apply secondary and primary power.



This instruction booklet is published solely for information purposes and should not be considered all inclusive. If further information is required, you should consult Cutler-Hammer.

Sale of product shown in this literature is subject to terms and conditions outlined in appropriate Cutler-Hammer selling policies or other contractual agreement between the parties. This literature is not intended to and does not enlarge or add to any such contract. The sole source governing the rights and remedies of any purchaser of this equipment is the contract between the purchaser and Cutler-Hammer.

NO WARRANTIES, EXPRESSED OR IMPLIED, INCLUDING WARRANTIES OF FITNESS FOR A PARTICULAR PURPOSE OR MERCHANTABILITY, OR WARRANTIES ARISING FROM COURSE OF DEALING OR USAGE OF TRADE, ARE MADE REGARDING THE INFORMATION, RECOMMENDATIONS AND DESCRIPTIONS CONTAINED HEREIN. In no event will Cutler-Hammer be responsible to the purchaser or user in contract, in tort (including negligence), strict liability or otherwise for any special, indirect, incidental or consequential damage or loss whatsoever, including but not limited to damage or loss of use of equipment, plant or power system, cost of capital, loss of power, additional expenses in the use of existing power facilities, or claims against the purchaser or user by its customers resulting from the use of the information, recommendations and description contained herein.

**Cutler-Hammer**

Pittsburgh, Pennsylvania U.S.A.