

New Information
 Reprint of B.15A.02.S.E
 pages 1-12, dated August 1998.

Open Transition IQ Transfer (ATC-600) for Automatic Transfer Switches

Table of Contents	Page
Introduction	2
Switch Application Section.	2
Programming.	2
Open Transition Front Panel	
Display and Button Functions	3
Operation	4
Programming and Options.	4
Standard Features.	5
Optional Features	6
Open Transition and the PowerNet System.	7
Using PowerNet.	7
Programmable Features/Set Points.	8
IQ Upgrade Module.	9
Dimensions	9



Introduction

The IQ Transfer (ATC-600) is a programmable microprocessor-based monitoring device designed for use in Cutler-Hammer Open Transition Transfer Switches (ATVI, BIVI, ATHI, BIHI) where rapid, reliable restoration of power in outage situations is essential.

IQ Transfer (ATC-600) features proprietary Cutler-Hammer designed SURE Chip microprocessor technology to provide superior precision and versatility in operation, programming and data access. In addition, the IQ Transfer's user-friendly front-panel interface simplifies routine operation, programming, data presentation, and adjustment of settings.

This unique combination of features makes IQ Transfer (ATC-600) the most complete and technologically-advanced ATS logic package available today.

Switch Application Section

Cutler-Hammer Open Transition IQ Transfer (ATC-600) Features

The IQ Transfer (ATC-600) is a door-mounted, totally enclosed device that is customer-accessible from the front panel.

Data access and programming operations are performed using the IQ Transfer's touch-sensitive function buttons in conjunction with an easy-to-read, illuminated, alphanumeric LED display. Both the function buttons and the display window are part of the device's front panel. A built-in Help button provides user assistance in the form of message displays.

The IQ Transfer (ATC-600) is communications ready and compatible with all Cutler-Hammer IQ devices as well as the Cutler-Hammer PowerNet system-wide supervisory and control software. This permits monitoring and control of several transfer switches, locally or remotely, from a single point.

IQ Transfer is suitable for either new or existing Cutler-Hammer ATS applications.

Additional Features:

- Applicable for use on any low or medium voltage application through 38 kV, 50 or 60 Hz.
- True rms three-phase voltage sensing on Normal, Emergency and Load.
- Frequency sensing on Normal and Emergency.
- Programmable set points stored in non-volatile memory.
- PowerNet Communication to personal computer either on-site or remote.
- Historical data on most recent transfers (up to 16 events) viewable at switch. Unlimited history storage (remote) available when used with PowerNet software.
- Wide range of user-selectable option combinations.
- Load sequencing.
- Engine start contacts.
- Engine Test Switch with user-selectable Test Mode and Fail-Safe.
- Alarm contact (multiple alarm functions available).
- Pre-transfer signal
- Heartbeat Monitor (flashing green Automatic light signifies that the IQ Transfer is operating properly).
- Instrumentation
 - Voltmeter (Accuracy $\pm 1\%$)
 - Reads line-to-line on Sources 1 and 2 and Load
 - Frequency Meter (40-80 Hz, accuracy $\pm .1$ Hz)
 - Source Available Time (both sources)
 - Source Connected Time (both sources)
 - Source Run Time

Programming

Button Functions

Three buttons provide easy access to all commonly used IQ Transfer (ATC-600) functions.

When the preferred source is connected and the ATS is operating normally, the Automatic indicator light will be flashing and the display window will be blank.

Using the Display Select button, the operator can step through each of the six display families:

- | | |
|------------|--------------|
| ■ Source 1 | ■ History |
| ■ Source 2 | ■ Time/Date |
| ■ Load | ■ Set Points |

Note: Stepping through the various display modes does not alter preset values or otherwise affect operation of the ATS.

Once the desired display family is selected, the user may press the Step button to cycle through specific parameters or metered values shown in the display window.

Initial Programming

Factory programming will load all customer-specified functions and presets. At the customer's request, Cutler-Hammer will add, delete or adjust optional features.

Customer Programming

Customers may reprogram set points and other parameters to match their application, using the Program switch located on the rear of the unit. Once the programming mode has been activated and the Program light is flashing, the user may access Set Point settings by pressing the Display Select button until the Set Points LED is illuminated. Values for individual set points may then be altered by pressing the Increase or Decrease buttons. Once a parameter has been reset, the user advances to the next set point by pressing the Step button.

While the IQ Transfer (ATC-600) is in the Program mode, the device continues to operate in accordance with the previously programmed set points and parameters. The unit is never off-line, and preset values do not change until programming has been completed.

Once reprogramming is complete, the user may return the Program switch to the Run position. At this point, all new values are stored in the IQ's non-volatile memory, and the unit returns to Automatic mode.

Open Transition IQ Transfer (ATC-600) Front Panel Display and Button Functions

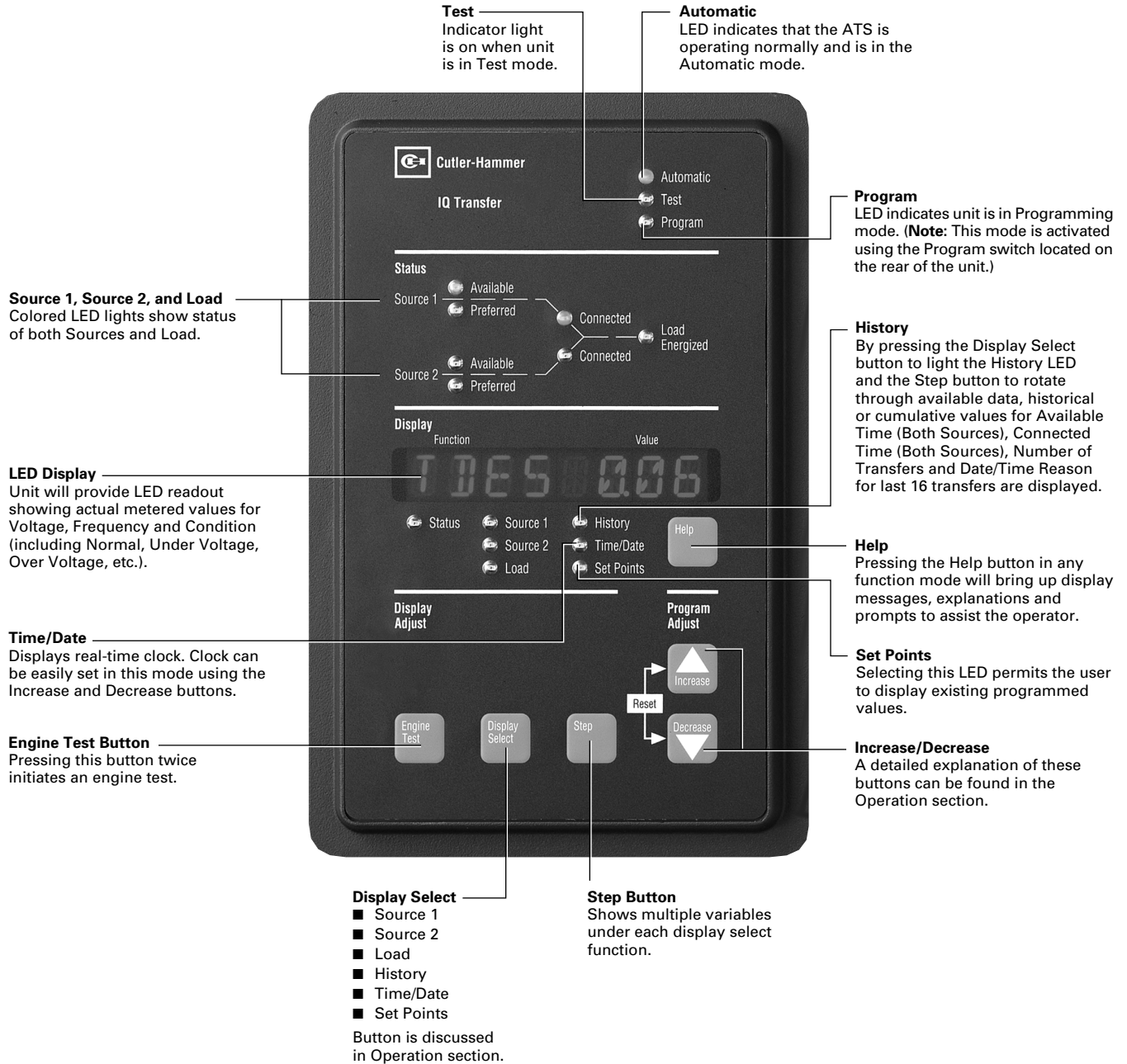

Operation

Definitions

Open Transition/Time Delay Neutral:

Time Delay Neutral is a feature that will provide a preset time delay in the neutral position allowing the voltage on the load to decay. This is an open transition that prevents inrush currents from exceeding normal starting currents when transferring motor loads. (Option 32A)

Open Transition/Delayed with Load Voltage Decay:

Load voltage decay transfer is a feature that, after opening the switch from the original source, holds in the neutral position until the voltage on the load is less than 30% of rated voltage. This is an open transition that prevents inrush currents in the case where motor loads are being transferred. (Option 32B)

Open Transition/In-Phase Monitor:

In-Phase Monitor is a feature that will allow a transfer between two sources only when the phase difference between the two sources is near zero. This is an open transition transfer that prevents inrush currents from exceeding normal starting currents in the case where motor loads are being transferred. (Option 32C and 32D)

Switch Operation

In the event of a power failure, the IQ Transfer will automatically become active. Once the alternate source becomes available, the IQ Transfer will display the status of timers and initiate a transfer.

Programming and Options

In-Phase Open Transition Operation Modes

Option 32C

In-Phase Monitor/Load Voltage Decay

IQ Transfer (ATC-600) controllers equipped with Option 32C execute the following sequence of operations upon receipt of a request for transfer:

The controller waits (for a pre-selected time frame) for synchronization of voltage and frequency. If achieved, an open transition in-phase transfer occurs. Failure to synchronize results in the controller automatically defaulting to an open transition Load Voltage Decay mode of operation, resulting in an assured transfer. If the back-up default mode is not desired, it may be effectively deactivated via a field programming change to the IQ Transfer (ATC-600) controller.

Standard Features	Customer Adjustments
In-Phase Transition Frequency Difference (Hertz)	0.0 to 3.0 Hz
In-Phase Transition Synchronization Timer	1 to 60 Minutes
Load Voltage Decay Threshold	0.0 to 30% of Nominal Voltage

Option 32D

In-Phase Monitor/Time Delay Neutral

IQ Transfer (ATC-600) controllers equipped with Option 32D execute the following sequence of operations upon receipt of a request for transfer:

The controller waits (for a pre-selected time frame) for synchronization of voltage and frequency. If achieved, an open transition in-phase transfer occurs. Failure to synchronize results in the controller automatically defaulting to an open transition Load Voltage Decay mode of operation, resulting in an assured transfer. If the back-up default mode is not desired, it may be effectively deactivated via a field programming change to the IQ Transfer (ATC-600) controller.

Standard Features	Customer Adjustments
In-Phase Transition Frequency Difference (Hertz)	0.0 to 3.0 Hz
In-Phase Transition Synchronization Timer	1 to 60 Minutes
Time Delay Neutral Timer	0.0 to 2 Minutes

Standard Features

Quick Summary of IQ Transfer (ATC-600) Factory Options and Customer Adjustments

The following chart illustrates standard features (Feature Group 9) of an IQ Transfer (ATC-600) unit.

Standard Features	Feature Number	Customer Adjustments
Voltmeter for Source 1	–	–
Voltmeter for Source 2	–	–
Voltmeter for Load	–	–
Frequency Meter for Source 1	–	–
Frequency Meter for Source 2	–	–
Under Voltage Sensing on Source 1	–	1-Phase or 3-Phase – Depending on System Voltage Dropout Voltage – 90% of Nominal to 50% of Nominal Pickup Voltage – 100% of Nominal to (Dropout + 2%)
Under Voltage Sensing on Source 2	5J	1-Phase or 3-Phase – Depending on System Voltage Dropout Voltage – 90% of Nominal to 50% of Nominal Pickup Voltage – 100% of Nominal to (Dropout + 2%)
Under Frequency Sensing on Source 2	5J	Dropout Frequency – 100% of Nominal to 90% of Nominal Pickup Frequency (Dropout + 1 Hz)
Time Delay Normal to Emergency	1	Adjustable 0-1800 Seconds
Time Delay Emergency to Normal	3	Adjustable 0-1800 Seconds
Time Delay Engine Start	2	Adjustable 0-120 Seconds
Time Delay Engine Cooldown	4	Adjustable 0-1800 Seconds
Time Delay Emergency Failure	7	Adjustable 0-6 Seconds
System Selection	–	Utility/Generator or Dual Utility or Dual Generator
Position Indicators	12C, 12D	–
Source Availability Indicators	12G, 12H	–
Preferred Source Indicator	–	–
Load Energized Indication	–	–
History		
Source Availability Time	–	–
Source Run Time	–	–
Source Connected Time	–	–
Load Energized Time	–	–
Number of Transfers	–	–
Date, Time and Reason for last 16 Transfers	–	–
Viewable Set Points	–	–
PowerNet Capability	–	Communications via PowerNet on Personal Computer
Real-Time Clock	–	Set Time and Date
Programmable Engine Test	6	Run Engine Only or Load Test
Remote Alarm Contact	–	–
Auxiliary Relay Contacts	14C, 14D	–

Optional Features

Quick Summary of IQ Transfer (ATC-600) Factory Options and Customer Adjustments

The following chart illustrates factory installed optional features of an IQ Transfer (ATC-600) unit.

Optional Features	Feature Number	Customer Adjustments
Over Voltage Sensing on Source 1	26C	Dropout Voltage – 120% of Nominal to 105% Pickup Voltage – 95% of Nominal to (Dropout – 2%)
Over Voltage Sensing on Source 2	5E	Dropout Voltage – 120% of Nominal to 105% Pickup Voltage – 95% of Nominal to (Dropout – 2%)
Under Frequency Sensing on Source 1	26E	Dropout Frequency – 100% of Nominal to 90% of Nominal Pickup Frequency – 110% of Nominal to (Dropout + 1 Hz)
Over Frequency Sensing on Source 1	26F	Dropout Frequency – 120% of Nominal to 100% of Nominal Pickup Frequency – 90% of Nominal to (Dropout – 2%)
Over Frequency Sensing on Source 2 (Also Includes Over Voltage Sensing on Source 2)	5K	Dropout Frequency – 120% of Nominal to 100% of Nominal Pickup Frequency – 90% of Nominal to (Dropout – 2%)
Time Delay Bypass Pushbutton Manual Return to Source 1	8C or 8D 29E	– –
Delayed Transition Time Delay Neutral Load Voltage Decay In-Phase Monitor/Load Voltage Decay In-Phase Monitor/Time Delay Neutral Timer	32A 32B 32C 32D	0-120 Seconds 0-30% of Nominal Voltage In-Phase Frequency Difference – 0.0 to 3.0 Hz In-Phase Synchronization Timer – 1 to 60 Minutes Load Voltage Decay – 0 to 30% of Nominal Voltage In-Phase Frequency Difference – 0.0 to 3.0 Hz In-Phase Synchronization Timer – 1 to 60 Minutes Delayed Transition Timer – 0 to 120 Seconds
Preferred Source Selection Maintenance Selector Switch	10B or 10D 9	Selectable – Source 1 or Source 2 or None –
Plant Exerciser with Real-Time Clock	23J	Set Mode (Load or No-Load Test) with Fail Safe and Time and Day of Exercise
Interruptible Rate (Area Protection) Inhibit to Emergency	26D 36	– –
Load Sequencing Pre-transfer Signal Phase Rotation (Contact Factory for Availability.)	45 35 5H or 26H	Up to 10 Devices Time Delay Initiated or Confirmation Initiated (up to 10 Devices) –

Open Transition and the PowerNet System

IQ Transfer

Cutler-Hammer IQ Transfer (ATC-600) Switches through PowerNet allow remote monitoring of emergency, normal and load voltages, transfer status, transfer times and load energized time. Transfer switch current settings are easily verified, generator exercise schedules are verified and easily documented, and loads can be shed before transferring to emergency sources.

Power Quality



Monitoring, Event Triggering and Waveform Snapshot

Information and Systems Integration

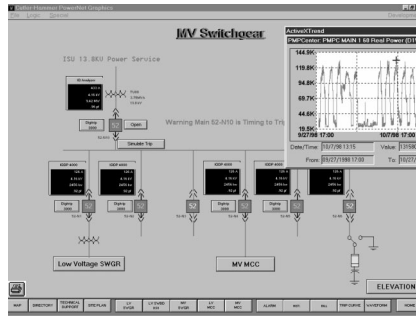

- Graphical one line, elevation and site plan interface
- Multi-vendor capable
- Real-time monitoring
- Scripting language
- Event logging
- Trending and reporting

Reliability and Uptime

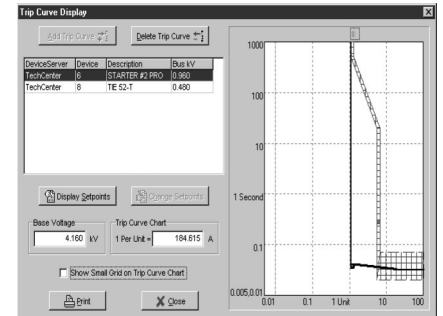

Online Coordination Verification Alarming and Paging

Energy Management

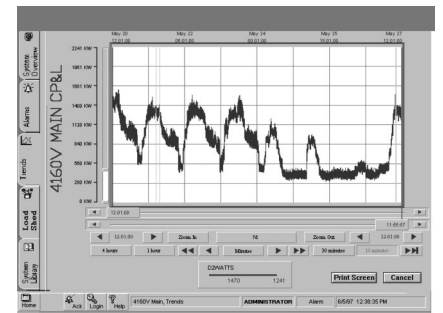

Load Profiling, Cost-allocation, Load Shifting, Arc Shredding and Peak Shaving

Using PowerNet, You Can Communicate with Your ATS and Other Electrical Distribution Assemblies

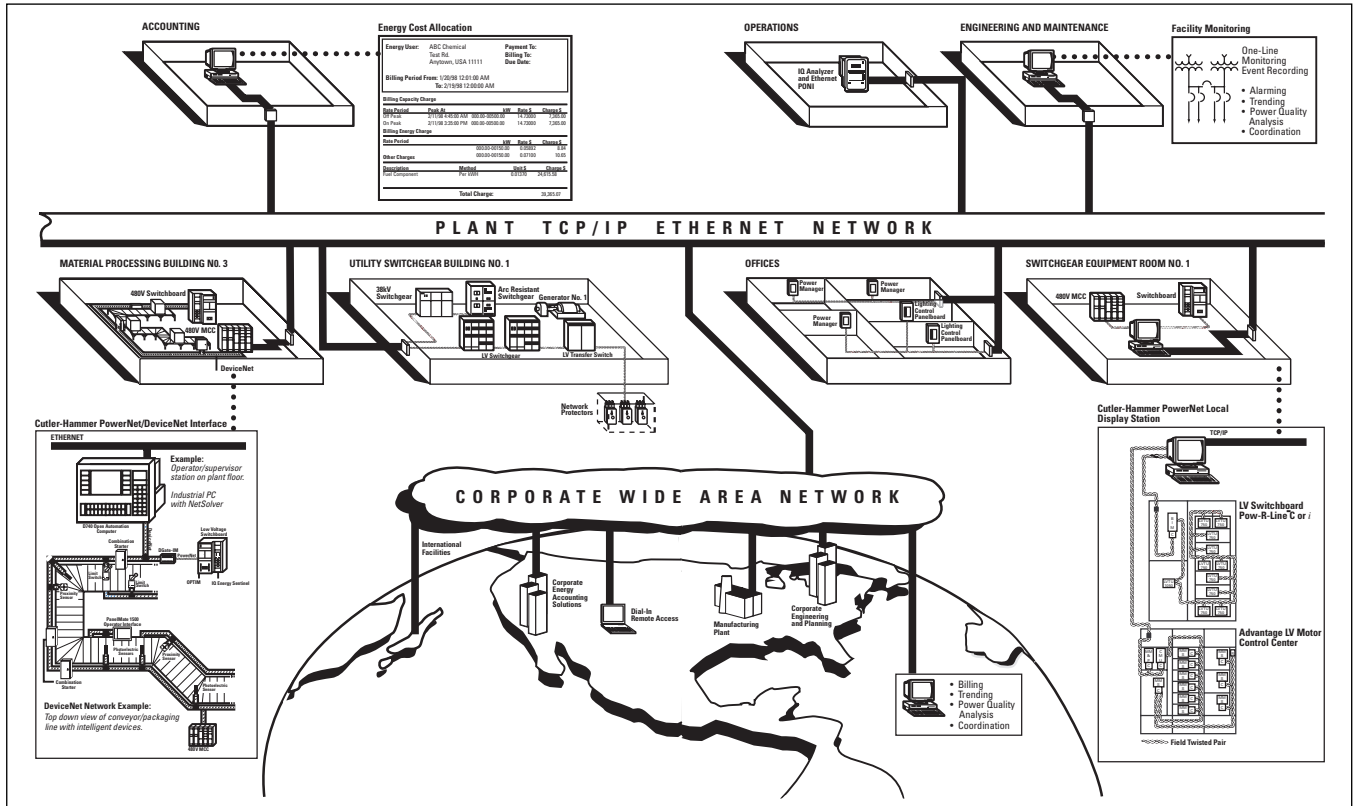

Programmable Features/Set Points

All Available Programmable Features/Set Points (Order Specific)

Programmable Feature Display	Set Point Possibilities	Display Explanation
TDES TDNE TDEN TDEC	0 to 120 Seconds 0 to 1800 Seconds 0 to 1800 Seconds 0 to 1800 Seconds	Time Delay Engine Start Timer Time Delay Normal to Emergency Timer Time Delay Emergency to Normal Timer Time Delay Engine Cooldown Timer
NOMF NOMV	50 or 60 Hz 120 to 600V	System Nominal Frequency (Hz) System Nominal Voltage (volts)
1UVD 2UVD 1UVP 2UVP	97% to 50% of Nominal 97% to 50% of Nominal (Dropout +2%) to 99% (Dropout +2%) to 99%	Source 1 Under Voltage Dropout (volts) Source 2 Under Voltage Dropout (volts) Source 1 Under Voltage Pickup (volts) Source 2 Under Voltage Pickup (volts)
1OVD 2OVD 1OVP 2OVP	105% to 120% 105% to 120% 103% to (Dropout -2%) 103% to (Dropout -2%)	Source 1 Over Voltage Dropout (volts) Source 2 Over Voltage Dropout (volts) Source 1 Over Voltage Pickup (volts) Source 2 Over Voltage Pickup (volts)
1UFD 2UFD 1UFP 2UFP	90% to 97% 90% to 97% (Dropout +1 Hz) to 99% (Dropout +1 Hz) to 99%	Source 1 Under Frequency Dropout (Hz) Source 2 Under Frequency Dropout (Hz) Source 1 Under Frequency Pickup (Hz) Source 2 Under Frequency Pickup (Hz)
1OFD 2OFD 1OFF 2OFF	103% to 110% 103% to 110% 101% to (Dropout -1 Hz) 101% to (Dropout -1 Hz)	Source 1 Over Frequency Dropout (Hz) Source 2 Over Frequency Dropout (Hz) Source 1 Over Frequency Pickup (Hz) Source 2 Over Frequency Pickup (Hz)
TDN	0 to 120 Seconds	Time Delay Neutral Timer
TDNLD	0 = Disabled 1 = Enabled	Time Delay Neutral Load Decay
LDCY	2% to 30% of Nominal Voltage	Load Decay Voltage
PRF SRC	None 1 = Source 1 2 = Source 2	Preferred Source
EXER	1 = Enabled 0 = Disabled	Plant Exerciser Enabled or Disabled
EXLD	1 = Enabled 0 = Disabled	Load Transfer with Plant Exerciser
PEDAY	1 to 7 (1 = Sunday)	Plant Exerciser Day of Week
PEH	1 a.m. to 11 p.m.	Plant Exerciser Hour
PEMIN	0 to 59 Minutes	Plant Exerciser Minute
MANTR	0 = Automatic 1 = PB Return	Retransfer Mode
CTDNE	0 = Not Committed 1 = Committed	Commitment to Transfer in TDNE
TMODE	0 = No Load Transfer 1 = Load Transfer 2 = Disable Test Pushbutton	Engine Test with/without Load Transfer
TER	0 to 600 Minutes	Engine Test/Plant Exerciser Run Time
TPRE	1 to 120 Seconds	Pre-transfer Sub-network Time Delay
GENNO	0 to 2	Number of Generators (Single Generator must be on Source 2)
PHASE	1 or 3	Number of System Phases
TSEQ	1 to 120 Seconds	Time Delay Load Sequencing
PT	2:1 to 500:1	PT Ratio
IPHASE	1 = Enabled 0 = Disabled	In-Phase Transition Enabled or Disabled
IPFD	0.0 to 3.0 Hz	In-Phase Transition Frequency Difference (Hz)
SYNC	1 to 60 Minutes	Closed/In-Phase Transition Synchronization Timer
TDEF	0 to 60 Seconds	Time Delay Emergency Fail

IQ Upgrade Module

If an optional feature needs to be added after a transfer switch is in the field, contact the factory for availability of field upgrades with the IQ Transfer Options Upgrade Module. This module can download new programs into the Open Transition IQ Transfer (ATC-600) via connection to the communication module connector on the rear of the IQ device.



IQ Transfer Options Upgrade Module

Dimensions in Inches (mm)

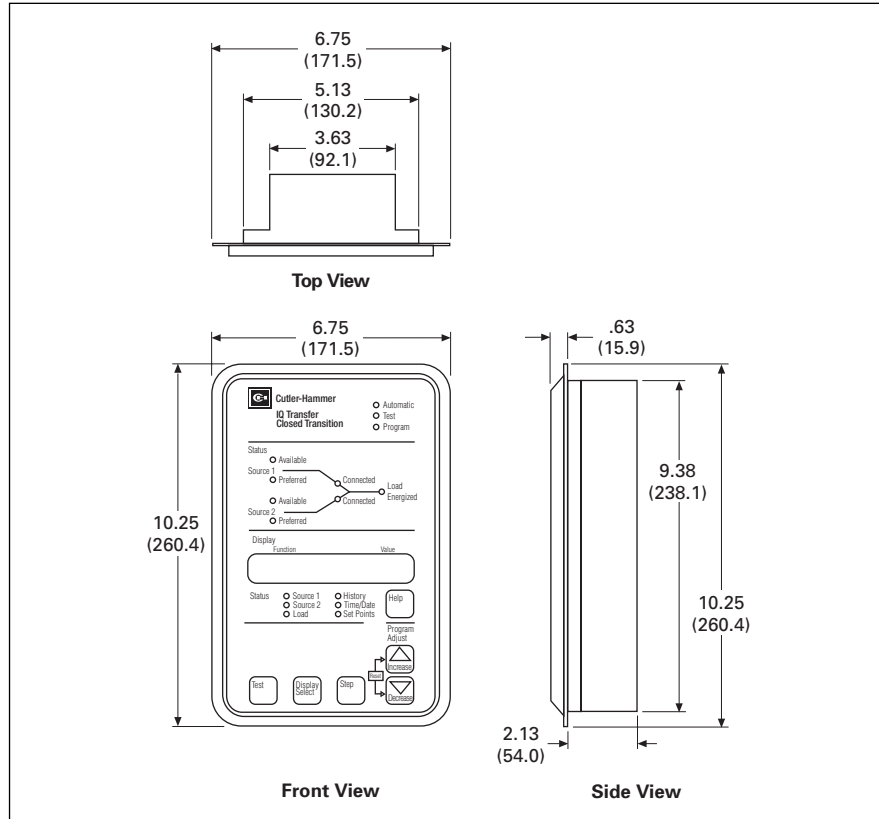

Open Transition IQ Transfer (ATC-600)

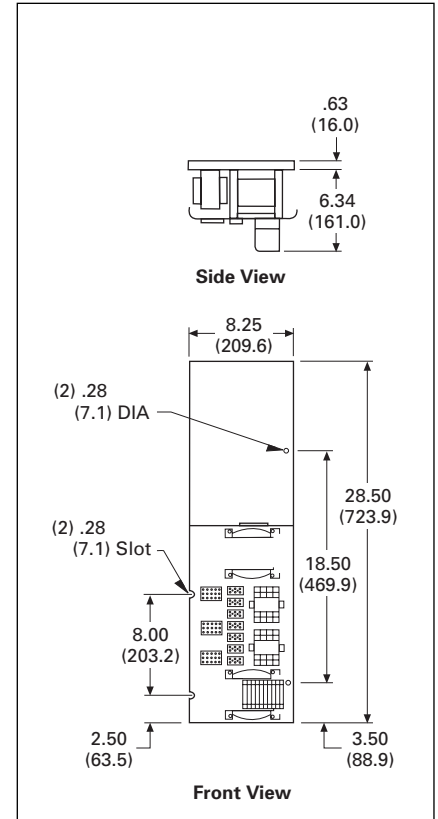

Typical Transformer Panel

Copyright Cutler-Hammer Inc., 2001.
All rights reserved.

Dimensions are approximate and should not be used for construction purposes (1 inch = 25.4 mm).

Notes

Notes

Notes

