

**MODEL 2000 AUTOMATIC TRANSFER
CONTROL SYSTEM**

Manual 5, Revision 15

Russelectric Inc.

Model 2000 Automatic Transfer Control System

Manual 5, Revision 15

For Use with Firmware Revision G, Hardware Revision G

Foreword

This manual is a guide to using the RUSSELECTRIC MODEL 2000 AUTOMATIC TRANSFER CONTROL SYSTEM.

The following pages describe the Model 2000 Automatic Transfer Control System with specific instructions on how the system operates. Included is a System Description, Installation Procedures, Operating Instructions, Troubleshooting, and an Appendix to provide you with a complete overview of all functions.

The Model 2000 is a microprocessor-based controller for either a Russelectric single motor ATS Model RMT, or a dual motor ATS Model RMTD. This controller allows the operator to monitor and control all operational functions of the Automatic Transfer Switch, including customer specified, standard, and optional accessories.

<u>Revision</u>	<u>Date</u>	<u>Changes Made</u>
As-Built	5/25/95	Updates to text 6/28/95
Rev. 1	8/30/95	Updates to As-Built Issue
Rev. 2 Issue (K)	9/13/95	Updates to Rev. 1 Issue
Rev. 3 Issue (L)	12/8/95	Updates to Rev. 2 Issue
Rev. 4 Issue (M)	3/07/96	Updates to Rev. 3 Issue
Rev. 5 Issue (N)	8/01/96	Updates to Rev. 4 Issue
Rev. 6 Issue (P)	10/21/96	Update to EPROM Software
Rev. 7 Issue (Q)	4/15/97	Update to EPROM Software
Rev. 8 Issue (R)	10/28/97	Revisions to Issue Q
Rev. 9 Issue (S)	5/8/98	Revisions to Issue R
Rev. 10 Issue (S)	9/24/98	Revised Figure 2 & 3 Titles; Revised Accessory 12A Description.
Rev. 11 Issue (T)	9/10/99	Update to Firmware Revision A
Rev. 12	12/15/99	Update to Firmware Rev. B, Hardware Rev. G
Rev. 13	1/24/00	Update to Firmware Rev. C, Hardware Rev. G
Rev. 14	9/26/00	Update to Firmware Rev. F, Hardware Rev. G
Rev. 15	3/15/01	Update to Firmware Rev. G, Hardware Rev. G

Table of Contents

Foreword	
Table of Contents	i
List of Figures.....	v
About This Manual.....	vi
Safety Precautions	ix
Nameplate Identification	xi
System Description	1
1.0 Overview	1
1.1 Transfer Switch Base.....	3
1.1.1 Spring Assembly.....	4
1.1.2 Motor Operator.....	5
1.1.3 Auxiliary Contacts.....	5
1.1.4 Contact Positions.....	5
1.2 Model 2000 Automatic Transfer Control System.....	7
1.2.1 Introduction	7
1.2.2 Control System Software/Hardware	7
1.3 Theory of Operation	11
Installation	2
2.0 Inspection	1
2.1 Switch Installment	3
2.1.1 Wall-Mounted Enclosed Switches.....	3
2.1.2 Free-Standing Enclosed Switches.....	4
2.1.3 Conduit Installation	5
2.1.4 Power Cabling	5
2.1.5 Control Wiring Connections.....	6

Operating Instructions

3

3.0 Operating the Automatic Transfer Switch	1
3.1 ATS Manual Operation	2
3.1.1 Manual Operator (Internal).....	2
3.1.2 Manual Operator (External)	3
3.2 Model 2000 ATS Control System	5
3.2.1 Introduction	5
3.2.2 Viewing the Main Menu Screen	5
3.2.3. Parameter Setup.....	6
F1 Timer Setup.....	7
F2 Normal Setup	9
F3 Emergency Setup	13
F4 Synchronizing Check Setup	13
F1 and F2 Phase Sequence Setup	14
F3 Exerciser Setup	15
F4 Clock Setup.....	17
F1 Serial Communication Setup.....	18
F2 Reset Default Values.....	20
F3 Reset Exerciser Events.....	20
3.2.4 Control ATS.....	21
F1 Timer Bypass Setup	22
F2 Start Load Test.....	23
F3 Stop Load Test.....	23
F4 Bypass BTR	24
F1 Commit.....	24
F2 No Commit.....	25
F1 Exerciser (Ex) Override On	26
F2 Exerciser (Ex) Override Off.....	27
F1 Exerciser On.....	27
F2 Exerciser Off.....	28
F3 Exerciser (Ex) Load.....	29
F4 Exerciser (Ex) No-Load	30
F1 Daylight Savings On	31

F2 Daylight Savings Off.....	31
F3 Maint Emer On.....	32
F4 Maint Emer Off.....	33
F1 Auto Tran Mode.....	34
F2 Man Tran Mode.....	34
F3 Tran to Normal.....	35
F4 Tran to Emer.....	36
3.2.5 Viewing ATS Status.....	37
F1 System Status.....	37
F2 Timer Status.....	41
F3 Normal Source.....	41
F4 Emergency Source.....	42
F1 Sync Check Status.....	42
F2 System Time.....	43
Firmware Status.....	44
3.2.6 Accessory Setup.....	45
3.2.7 Historical Data.....	47
F1 Display Historical (Disp Hist) Data.....	47
F2 Display (Disp) Source Data.....	49
F3 Record Reset.....	50
3.3 Optional Accessory Plate Status and Operation.....	51
3.3.1 Annunciation Devices.....	51
3.3.2 Control Switches and Push Buttons.....	52
Alarm Horn Silence - ACC28.....	52
Block Transfer-To-Emergency Override - BTRK.....	52
Bypass Time Delay On Retransfer-To-Normal (TD2) - ACC6B.....	52
Exerciser Mode Selector Load/No Load - ACC11C.....	52
Exerciser Mode Selector On/Off - ACC11D.....	52
Load Test - ACC5A.....	53
Maintain Emergency Position - ACC5D.....	53
Retransfer-To-Normal - ACC6A.....	53
Retransfer-To-Normal - ACC6E.....	53
Retransfer-To-Normal - ACC6F.....	53

Transfer Mode Selector - ACC12B.....	53
Transfer Mode Selector - ACC12C.....	54
Transfer Mode Selector - ACC12X.....	54
Transfer-To-Emergency - ACC6F.....	54
Troubleshooting & Maintenance	4
4.0 General.....	1
4.1 Preventive Maintenance.....	1
Troubleshooting Chart.....	3
Startup Checklist.....	(inserted section pages 1-5)
Appendix	5
Accessory List.....	2

List of Figures

System Description	1
Figure 1. The Automatic Transfer Switches - Typical One-Line Diagram.....	2
Figure 2. The 100 - 2000A Transfer Switch Base (400A, 3-pole dual motor)	3
Figure 3. The 3000 - 4000A Transfer Switch Base (3-pole dual motor)	4
Figure 4. The Model 2000 Automatic Transfer Control System	7
Figure 5. Status LEDs.....	9
Installation	2
Figure 6. Unpacking the Switch.....	1
Figure 7. Transfer Switch Installation	2
Figure 8. Typical Wall-Mounted Enclosure	3
Figure 9. Free-Standing Enclosure	4
Figure 10. Wall-Mounted Relay Plate Connections	8
Figure 11. Free-Standing Relay Plate Connections.	8
Operating Instructions	3
Figure 12. Manual Operator.....	3
Figure 13. External Manual Operator.....	3
Figure 14. Contact Position Indicator.....	4
Figure 15. Optional Accessory Plate.....	51

About This Manual...

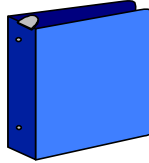

This manual consists of the following five sections: System Description, Installation Procedures, Operating Instructions, Troubleshooting, and an Appendix. Preceding these sections is the Title Page, Foreword, Table of Contents, List of Figures, About This Manual, Field Service Data, Safety Precautions, and Nameplate Identification.

The manual is shipped with the most recent date. If changes are made to the manual, a revision change occurs, and the manual displays the next revision number.

Front Matter

- ◆ Title Page (Manual Name, Revision Level)
- ◆ Foreword
- ◆ Table of Contents
- ◆ List of Figures
- ◆ About This Manual
- ◆ Company Address, Field Service Information
- ◆ Safety Precautions
- ◆ Nameplate Identification.

Sections

Section 1. System Description

This section is an overview of the Model 2000 Automatic Transfer Control System with a description of each component.

Section 2. Installation

This section contains information on how to install, mount, and connect wires for the Model 2000 Automatic Transfer Control System.

Section 3. Operating Instructions

This section describes how the Model 2000 Automatic Transfer Control System operates. It includes all automatic and manual procedures.

Section 4. Troubleshooting

The Troubleshooting section contains information about preventive maintenance procedures, transfer to emergency procedures, and re-transfer to normal procedures.

Section 5. Appendix

This section contains the Accessory Table and other system specifications.

**© Copyright 2001, Russelectric Inc.
All Rights Reserved**

RUSSELECTRIC INC.

South Shore Park, Hingham, MA 02043-4387

(781) 749-6000

FIELD SERVICE INFORMATION

To order supplies and replacement parts, or if a problem arises with your system, please contact a field service representative at

(781) 749-6000 or the 24-hour emergency number 800-654-3020.

Telefax (781) 749-8077



NOTICE

*The information in this manual is subject to change.
This manual is believed to be complete and accurate at the
time of publication and no responsibility is assumed for any errors
that may appear. In no event shall Russelectric Inc. be liable for incidental or
consequential damages in connection with or arising
from the use of the manual and its accompanying related materials.*

Safety Precautions

Special information for the operator is divided into four types. The precautions contained in these Notes, Cautions, Warnings, and Dangers, provides a clear method of detailing the severity of the information as it relates to the operation and/or personal safety of the operator:



NOTE

Note contains information that is pertinent to the relevant material.



CAUTION

Caution contains information that indicates unsafe conditions. Take notice of this message to prevent possible damage to equipment or personal injury.



WARNING

Warning contains information that indicates EXTREMELY HAZARDOUS conditions. Take notice of this message to prevent personal injury or possible death.



DANGER

Danger contains information that indicates FATAL conditions. Take notice of this message to prevent serious personal injury or death.

Safety Guidelines:

When working around cubicles, observe the following guidelines:

- Be careful when opening and entering cubicles. Dangerous voltages may exist on the interior sections.
- Keep all unattended cubicle sections closed and locked.
- Restrict all non-authorized individuals from exposed interior ATS areas.
- Ensure that the normal and emergency sources are shut down when servicing or cleaning ATS interiors.

Nameplate Identification

Each Russelectric Automatic Transfer Switch (ATS) is identified by a unique combination of model and serial numbers. These numbers, along with the electrical rating data, are provided on a nameplate affixed to the transfer switch.

Write the necessary information in the spaces provided on the sample nameplate, to keep a permanent and readily available record. This data is required to specifically identify your unit. When contacting the factory to order parts, you will need to provide the caller with the appropriate model and serial number for your system.

<i>Russelectric</i>	
MODEL 2000	
TRANSFER SWITCH CONTROL SYSTEM	
SERIAL	<input type="text"/>
<small>SSL0003028-A</small>	

<i>Russelectric Inc.</i>			
<small>coordinated power control systems</small>			
<small>SO. SHORE INDUSTRIAL PARK</small>		<small>HINGHAM, MASS.</small>	
<small>(617) 749-6000</small>			
MODEL	<input type="text"/>		
SERIAL	<input type="text"/>	AMPS	<input type="text"/>
VOLTAGE	<input type="text"/>		
PHASE	<input type="text"/>	WIRE	<input type="text"/>
		HZ	<input type="text"/>

1

System Description

1.0 Overview

The Russelectric Automatic Transfer Switches (ATS) are modern, high-speed switching devices. These devices are designed to transfer electrical loads from a normal source to an emergency power source upon reduction or loss of voltage, and to re-transfer loads once normal power is restored. There are two ATS models available:

- RMT
- RMTD.

RMT

The model RMT is a double-throw, single motor automatic transfer switch, commonly used for critical loads. This device is actuated by a simple over-center type mechanism to an electrical motor, and is momentarily energized to transfer load. Total transfer time does not exceed one-half of a second, and is capable of transferring successfully in either direction.

RMTD

The model RMTD is a dual motor, automatic transfer switch, generally used to transfer large inductive motor loads between two sources of power that are not in synchronism with one another. This transfer switch provides an adjustable off-time period. This means that both sets of contacts remain open during the timing cycle. The *center-off* position of the dual-motor switch avoids false triggering and latch-up of Silicon Controlled Rectifier (SCR) power devices, when they are transferred between two asynchronous power sources. This switch is often used in conjunction with generator paralleling systems because of its ability to be maintained in the *center-off* position.

Both the RMT and RMTD models are provided with mechanical and electrical position interlocks. These interlocks prevent simultaneous closing of both sets of contacts. The automatic transfer switch contains two basic components:

- Transfer switch base
- Control system.

Figure 1. The Automatic Transfer Switches - Typical One-Line Diagram

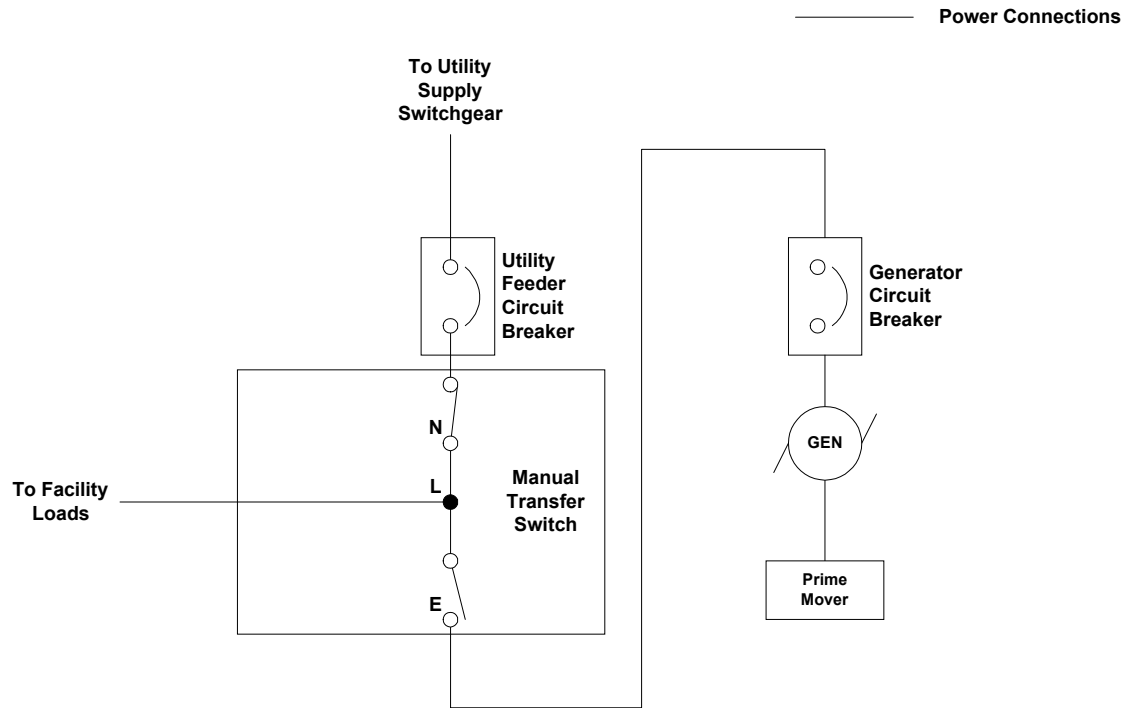

1.1 Transfer Switch Base

The transfer switch base provides two sets of fully-rated, main contacts for transferring the main load between the normal and emergency sources. One or two unidirectional motors are used to operate the contacts. There are also auxiliary transfer switch contacts for the control system and customer use.

Figure 2. The 100-3000A Transfer Switch Base (400A, 3-pole dual motor shown below)

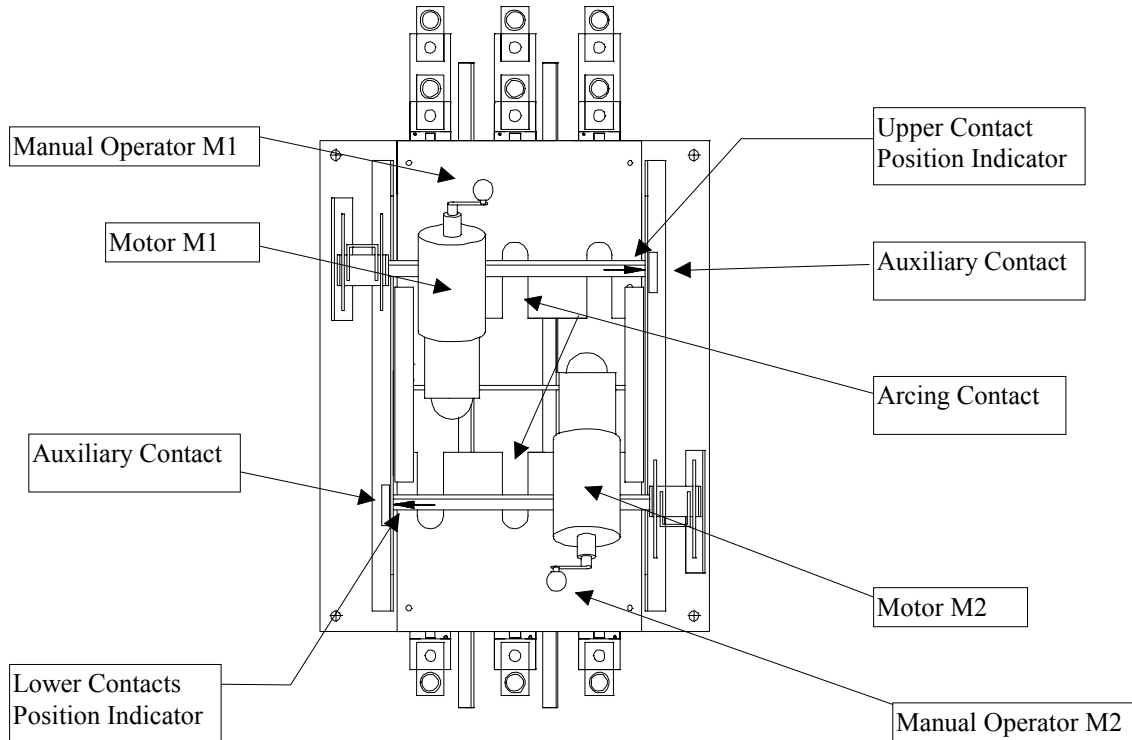
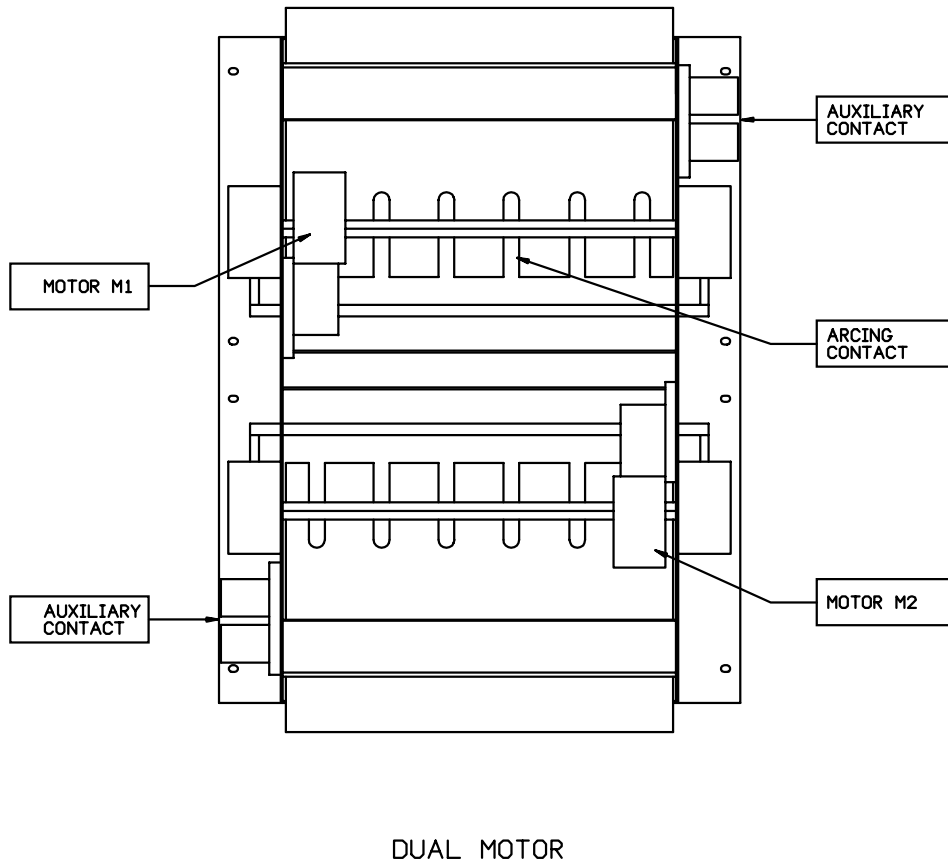

Figure 3. The 4000A Transfer Switch Base (3-pole dual motor shown below)



1.1.1 Spring Assembly

Springs are connected to the transfer switch contacts to allow the contact sets to operate independently of both the motor and manual operators. The pre-load springs are charged in the first 120° of travel. Once the springs travel past 120°, or the *over-center* position, they operate the contacts at high speed ahead of the motor or manual operators until the contacts are locked by a knee-locking mechanism in the closed position. The springs then snap open the closed contact set (quick break) and snap close the open contact set (quick make) with a momentary break in between. The quick break feature provides for full arc interruption, with maximum voltage and amperage in less than one-half cycle, to considerably reduce contact erosion and increase the useful life of the switch. This eliminates the possibility of a flash or heavy arcing during manual operation. It also provides safe, manual operation of the transfer switch at the same contact-to-contact operating speed as the electrical operator.

1.1.2 Motor Operator

A high-torque motor, operating in one direction only for both opening and closing operations, actuates the transfer switch operation to either the normal or emergency position as determined by the control circuitry. The motor is connected to the linkage rod through a drive arm assembly. The linkage rod is connected to the springs, and the springs are connected to the contact set. As the motor rotates, the drive-arm mechanism drives the linkage rod to charge the springs.

The dual motor automatic transfer switches operate similar to the single motor, except they provide an independent motor for each contact set.

1.1.3 Auxiliary Contacts

Auxiliary contacts are located on the movable shaft of each contact set. These contacts are used in the control logic circuitry of the transfer switch to disconnect power to the motor operator when the switch transfers. Extra contacts are available for other customer requirements.

1.1.4 Contact Positions

The position of the contacts on the wiring diagrams show normal and emergency power in a de-energized state. Below is an example of four contact positions:

- **Normal Shaft Closed**

The contact on the normal shaft is **closed** when the switch is in the *Normal* position. It **opens** when it is in the *Emergency* position.

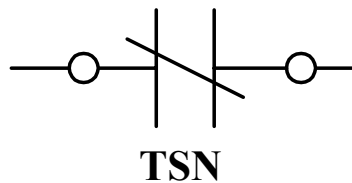

- **Normal Shaft Open**

The contact on the normal shaft is **open** when the switch is in the *Normal* position. It is **closed** when the switch is in the *Emergency* position.

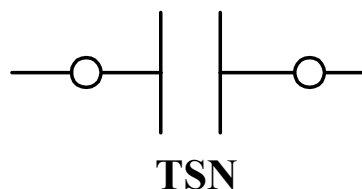

- **Emergency Shaft Closed**

The contact on the emergency shaft is **closed** when the switch is in the *Normal* position. It **opens** when it is in the *Emergency* position.

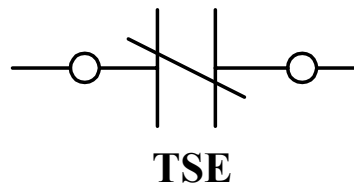

- **Emergency Shaft Open**

The contact on the emergency shaft is **open** when the switch is in the *Normal* position. It is **closed** when the switch is in the *Emergency* position.

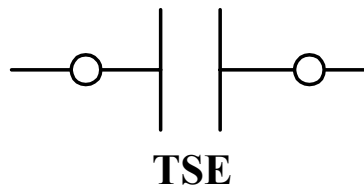

1.2 Model 2000 Automatic Transfer Control System

Figure 4. The Model 2000 Automatic Transfer Control System

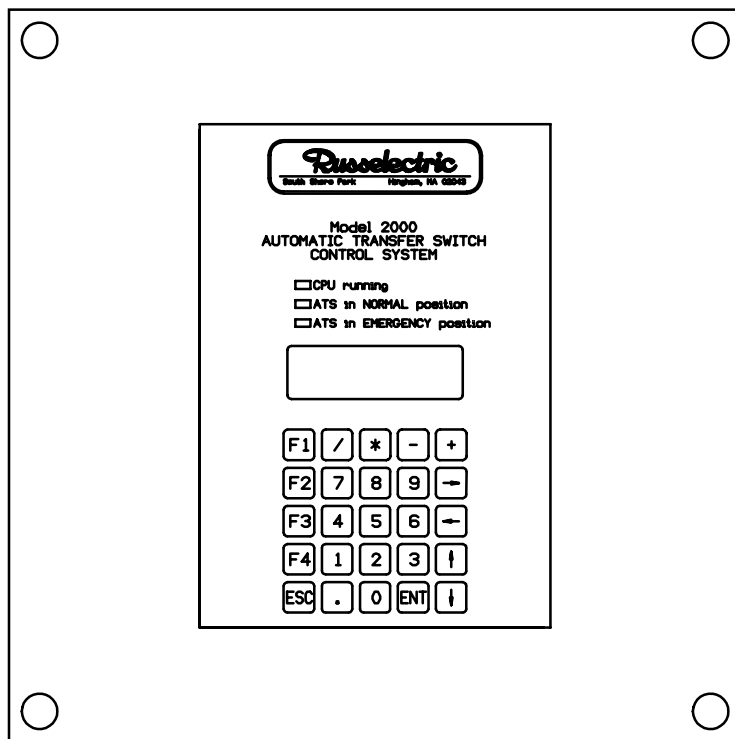

1.2.1 Introduction

The Model 2000 is a microprocessor-based controller for use with either the Model RMT or RMTD transfer switches. Located on the front of the cubicle door, this controller allows the operator to program and monitor various ATS functions through an operator interface. Its primary function is to transfer the main load to the currently available source. In addition, the controller also performs secondary functions such as load test, exercise mode, and peak shave. Provisions are made for remote monitoring and control through a serial communications port.

1.2.2 Control System Software/Hardware

Software

The control system software is pre-programmed at the factory and stored on non-volatile Erasable Programmable Read-Only Memory (EPROM). Adjustable parameters are stored on Electrically Erasable Programmable Read-Only Memory (EEPROM) and are set to factory default values. An operator interface provides easy access to the control system.

Hardware

The Model 2000 Transfer Control System consists of:

- Microprocessor control board
- Power supply/motor control board
- Two voltage attenuator boards
- Operator interface.

Microprocessor Control Board

The microprocessor control board consists of:

- Eight-bit microprocessor with a 1MB memory management system
- Two asynchronous RS-422/485 communication ports
- Battery-backed real-time clock
- Microprocessor supervisor system (watchdog/power fail circuit)
- Discrete and analog I/O
- Eight status LEDs.

Operator Interface

The operator interface consists of:

- Three Light Emitting Diode (LED) indicators
- 20-character, four-line Liquid Crystal Display (LCD)
- 5 x 5 tactile keypad
- 8 status LEDs.

Light Emitting Diode (LED) Indicators

- **CPU Running**
Illuminates a green indicator when the CPU is running.
- **ATS in Normal Position**
Illuminates a green indicator when the transfer switch is in the normal position (the building load is connected to the normal source).
- **ATS in Emergency Position**
Illuminates a red indicator when the transfer switch is in the emergency position (the building load is connected to the emergency source).

Status LEDs

Figure 5. Status LEDs

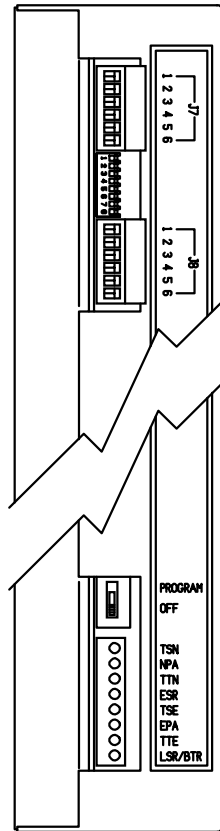

The following status LEDs are located on the right side of the controller.

- **(TSN) Normal Position**
Illuminates when the ATS is in the *Normal* position.
- **(NPA) Normal Power Available**
Illuminates when the normal power source is available.
- **(TTN) Transfer-to-Normal**
Illuminates when the ATS is in a retransfer-to-normal sequence. It flashes when either the TD2, TDBT, or TNTD timers are in a timing sequence.
- **(ESR) Engine Start Relay Status**
Shuts off when the engine is signaled to stop, and illuminates when the engine generator is signaled to start. The indicator flashes when either the TD1 or AUT timers are in a timing sequence.
- **(TSE) Emergency Position**
Illuminates when the ATS is connected to the emergency source.
- **(EPA) Emergency Power Available**
Illuminates when the emergency source is available.

- **(TTE) Transfer-to-Emergency**
Illuminates when the ATS is in a transfer-to-emergency sequence. This indicator flashes when either the TD3, TDBT, or TETD timers are in a timing sequence.
- **(BTR/LSR) Block Transfer and Load Shed Status**
Flashes if a load shed relay condition occurs, or if the transfer-to-emergency sequence is waiting for the block transfer relay signal from the generator control switchgear.

Power Supply/Motor Control Board

The power supply/motor control board contains a 20 W power supply and motor control relays.

Voltage Attenuator

The voltage attenuator boards are used to attenuate the normal and emergency primary voltages for input to the control system analog-to-digital converter circuit.

1.3 Theory of Operation

The Model 2000 Automatic Transfer Control System and Transfer Switchbase are designed to automatically transfer the load to the available source, with the normal source being the preferred source of power.

Under normal operating conditions the **LOAD TEST** switch is in the *Off* position, normal power is available, and the ATS is in the *Normal* position.

When the **LOAD TEST** switch is in the *Auto* position and the normal source is within acceptable voltage and frequency limits, the ATS is in the *Normal* position. The green ATS IN NORMAL POSITION light located on the front of the control panel illuminates.

When a loss or interruption of the normal source is detected, the controller initiates an engine start sequence. If normal power is unavailable for a period greater than the engine start delay preset (TD1), the engine start relay de-energizes. At this time the emergency source generator is commanded to start. When the voltage and frequency of the emergency source reaches acceptable limits, the transfer-to-emergency sequence begins.

There are two timers associated with the transfer-to-emergency sequence:

- Transfer-to-emergency time delay (TD3)
- Time delay before transfer (TDBT).

If these optional, adjustable, time delays are enabled, they are factory set at three and five seconds respectively. When the above mentioned time delays expire, the transfer switch motor operator transfers the main contacts from the normal source to the emergency source. If the transfer switch is a dual-motor operator (model RMTD) two motor operators are used. The normal source main contacts are opened with motor operator #1, then the adjustable emergency transition time delay (TETD) begins timing.

After expiration of the TETD, factory set at three seconds, the emergency source main contacts are closed using motor operator #2. The red ATS IN EMERGENCY POSITION light located on the front of the control panel illuminates.

Once normal power is restored, the time delay on re-transfer timer (TD2) begins timing. When the TD2 timer expires, the transfer switch motor operator transfers the main contacts from the emergency source to the normal source. If the transfer switch is a dual-motor operator (model RMTD) two motor operators are used. The emergency source main contacts are opened with motor operator #2, then the adjustable normal transition time delay (TNTD) begins timing. After expiration of the TNTD, factory set at three seconds, the normal source main contacts are closed using motor operator #1. The green ATS IN NORMAL POSITION light on the membrane switch illuminates.

Once the transfer switch retransfers to normal, the engine cool down timer (AUT) begins. When this adjustable timer (factory set at 300 seconds) expires, the engine start signal is removed, and the engine generator shuts down.

2 Installation

2.0 Inspection

The Russelectric Automatic Transfer Switch (ATS) is packed for shipment in a wooden crate, as shown in *Figure 6*. Upon receiving the ATS, check the crate for any obvious damage. Report any damage immediately to your local representative, or the Russelectric factory.



WARNING: Check out all rigging equipment to ensure that it is capable of lifting the switch. Failure to do so, may result in severe personal injury. Refer to switch dimensions and weights provided with installation drawings.

Smaller, enclosed, or open-type switches are not equipped with special bolts and must be installed by other means. Enclosed-type switches, 1000A, or above, are equipped with eye bolts for installation purposes.

Unpacking the Transfer Switch

Remove the transfer switch from the packing crate. Check the transfer switch and equipment for dents, scratches, or damage caused by shipping. If the switch is in good condition, discard the crate, otherwise, keep the crate for possible re-shipment.

Figure 6. Unpacking the Switch

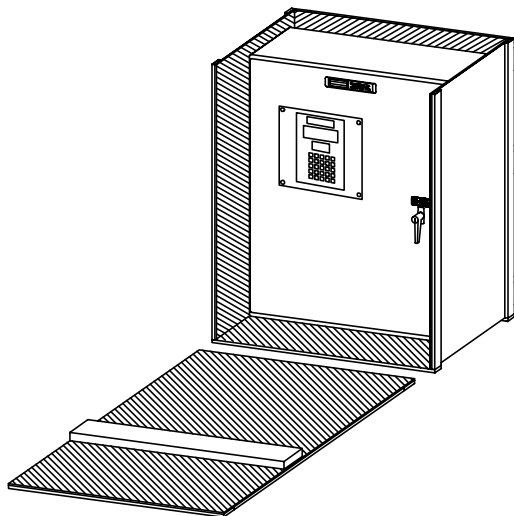

Mounting the Switch

Before you begin, consult the installation drawings provided with the transfer switch to ensure proper mounting of the switch and enclosure. Refer to *Figure 7* for identification purposes.

Figure 7. Transfer Switch Installation

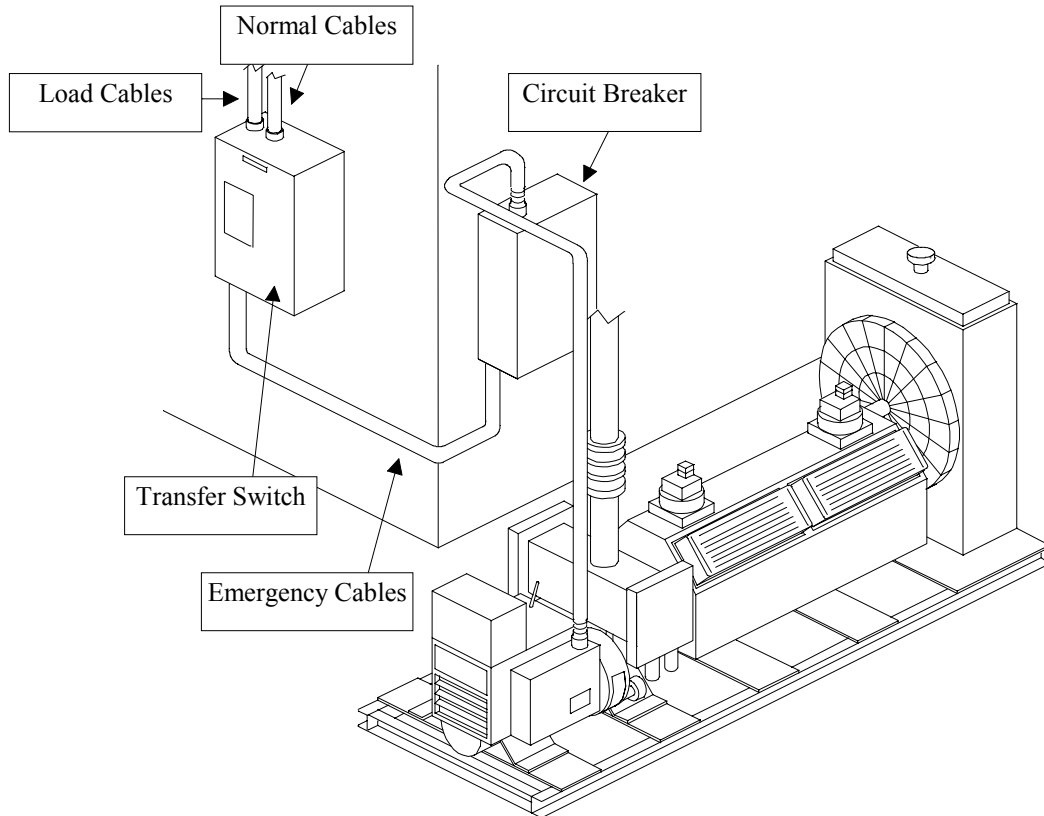

WARNINGS:

1. ***Before installing the transfer switch, ensure that there is a service disconnect in the commercial power line.***
2. ***Be sure to install the ATS in an area away from wires, plumbing, or gas exhaust lines.***
3. ***Do not install the equipment near fuel tanks, solvents, batteries, or any other flammable materials.***
4. ***Ensure that the mounting surface and the bolts used can support the weight of the transfer switch during normal operation.***
5. ***Mount the ATS on a smooth level surface. Failure to do so could cause problems racking the ATS in and out of its enclosure.***

2.1 Switch Installment

There are two ways to install a switch:

- Wall-Mounted
- Free-Standing.

2.1.1 Wall-Mounted Enclosed Switches

Figure 8. Typical Wall-Mounted Enclosure

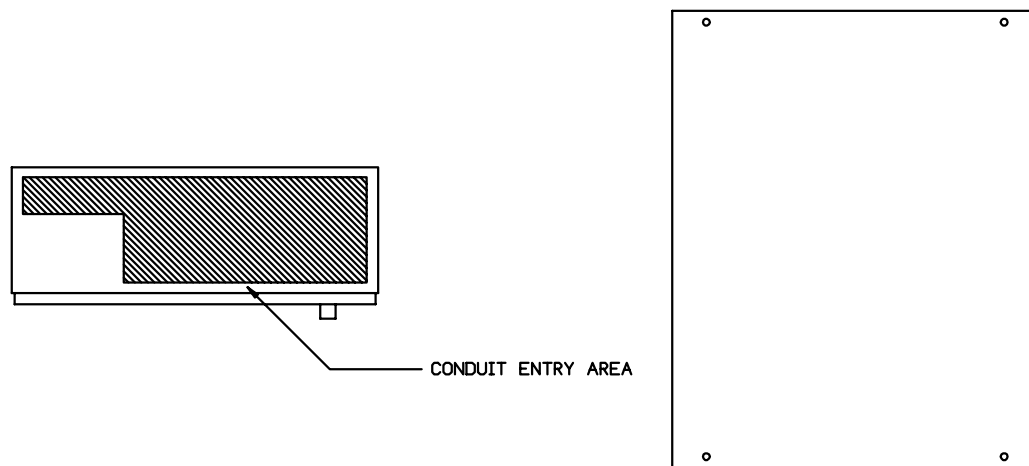

To install a wall-mounted enclosed switch:

1. Align the cabinet flush against the wall. If the cabinet does not align properly, place a wedge-type device in the area required to level the equipment.
2. Tighten all mounting bolts. *Figure 8* shows a typical wall-mounted enclosure with the mounting hole locations.
3. Once the switch is installed, check all mounting and enclosure bolts for tightness.

2.1.2 Free-Standing Enclosed Switches

Figure 9. Free-Standing Enclosure

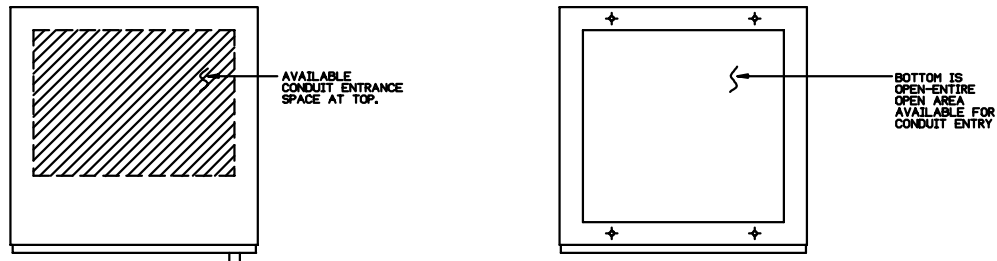

To install a free-standing enclosed switch:

1. Ensure that the base foundation has been leveled properly.
2. Verify that the anchoring holes are positioned correctly by measuring them before installing the switch. Tighten all mounting bolts. *Figure 9* shows a typical free-standing enclosure with the mounting hole locations.



NOTE: *If bottom entry is required on a free-standing switch, ensure that the height of the conduit is within limits as specified on the drawings. If the conduit is too high, the conduit may need to be cut and re-threaded to provide cable bending space. If the switch requires top entry, ensure that the conduit or duct is terminated in the area as outlined on the installation drawing.*

3. Once the switch is installed, check all mounting and enclosure bolts for tightness.
4. Clean the enclosure and switch to remove any shavings or other material that may have entered during installation.
5. Check the mounting of all components and all wiring terminals. Tighten where necessary.
6. Check the door of the enclosure, locking bars, and mechanism for proper operation and alignment.
7. Operate all control switches and check for free movement and contact continuity.
8. Manually operate the transfer switch to ensure proper switching action. Refer to the **Operating Instructions** section in this manual.



NOTE : *Report any defects to your local representative or the Russelectric factory.*

2.1.3 Conduit Installation



WARNING: Before beginning conduit installation, cover the transfer switch to prevent the accidental entry of metal chips. A common cause of failure is the result of metal chips penetrating through the enclosure and falling into the terminals of the transfer switch. Cutouts can then be made through the top or bottom of the cabinet.

1. Prior to connecting the ATS, perform a meggar test to the normal, emergency, and load cables.
2. Verify that the phase rotation of the emergency and normal building sources are the same, and that they are proper for the building loads. Make corrective actions before proceeding with this installation procedure.



WARNINGS: Before installing the cable, ensure that the circuit breakers or disconnects to the normal and emergency sources are opened.

3. Open all breakers or disconnects on the load service switchboard or panel.
4. Install conduit in accordance with the National Electrical Code and local code standards and requirements.
5. Ensure that the cabinets and main frames of all equipment are solidly grounded prior to the application of power.



NOTE: The transfer switch controller is factory set for ABC phase sequence for both normal and emergency sources. If CBA phase sequence is required, upon power up change the phase sequence as outlined in Section 3.2.3, Phase Sequence Setup.

2.1.4 Power Cabling



NOTE : Wiring diagrams are furnished with this manual. Refer to these drawings for special accessories included with the transfer switch. All wiring must be manufactured in accordance with the National Electrical Code and local codes.

1. Check the ATS nameplate to determine proper operation specifications, voltage, phase, wire, and current. Be certain to record this information in the *Nameplate Identification* section in the front of this manual for reference.
2. Check the installation drawings for cable size, and lug data. If the connecting cable is not the same size as specified on the drawings, notify the Russelectric factory.



DANGER: All line conductors and auxiliary circuit conductors must be de-energized before connecting to the transfer switch. Normal and Emergency line connections must be in proper phase rotation.

3. Place the engine generator starting control in the **Off** position. If the engine-generator set is used in this operation, be certain that it is not in operation.
4. Bundle all cables on the left side of the transfer switch. Do not run cables behind the transfer switch. Maintain proper electrical clearance (1" minimum) between the live metal parts and grounded metal.
5. Connect source and load conductors to clearly marked terminal lugs on the transfer switch. Refer to the wiring diagrams furnished with this manual for complete details.



WARNINGS: Be careful when stripping insulation from the cables. Avoid nicking or ringing the conductor.

6. Remove surface oxides from cables by cleaning with a wire brush. When an aluminum conductor is used, apply joint compound to conductor, then carefully wipe away excess compound.
7. Tighten the cable lugs to the torque specified on the rating label.

2.1.5 Control Wiring Connections

Observe the following safety precautions before connecting the control wires:



DANGER: Failure to prevent the generator set from starting before wiring procedures are performed may result in severe shock, causing personal injury or death.



WARNING: Run control circuit wiring in a separated conduit from the power wiring; otherwise, induced currents could cause operational problems within the transfer switch. If cable connections need to be changed from top to bottom or vice versa, you must run an external conduit. Do not attempt to run cables across the front of the relay panel.



WARNING: Ensure that the control and power wires are separated in the enclosure. Failure to observe this warning may result in false inputs being fired by noise.

STEPS:

1. Once the enclosure is cut and cables are installed, clean the transfer switch and remove any drill chips.
2. Make a final inspection to ensure that no damage has occurred. If there is any damage, report it to your Russelectric representative.
3. Consult the schematic and wiring diagrams furnished with the ATS before attempting to connect control wires. *Figure 10* (shown on the next page) illustrates the connections for a wall-mounted relay plate. *Figure 11* shows the connections for a free-standing relay plate.



WARNING: Improper wiring of start-stop connections can result in severe personal injury or equipment damage. Carefully follow all wiring instructions.

4. Install wiring in accordance with the National Electrical Code and local code standards and requirements.

Figure 10. Wall-Mounted Relay Plate Connections

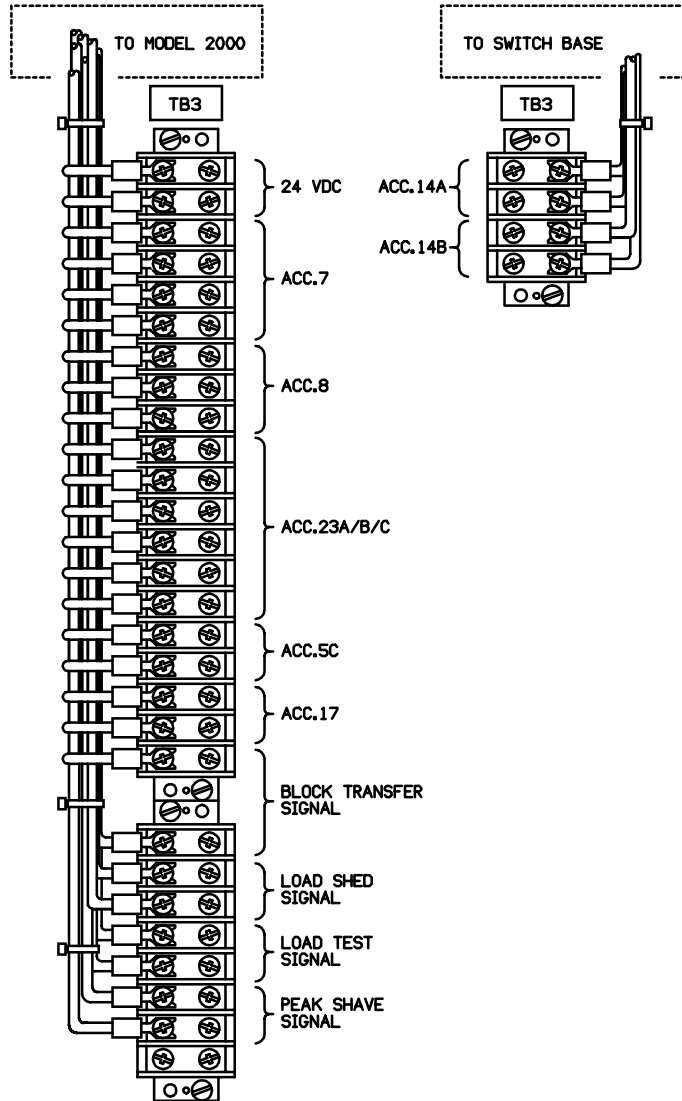
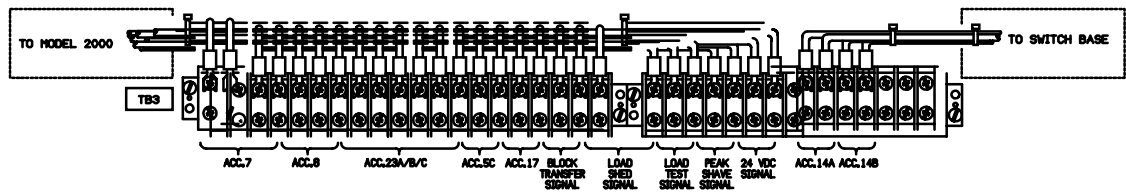

Figure 11. Free-Standing Relay Plate Connections



3 Operating Instructions

3.0 Operating the Automatic Transfer Switch

The following instructions explain how to operate the Automatic Transfer Switch (ATS). The operator can perform functions by using the manual operator, switches on the accessory plate, or by pressing the appropriate keys on the Model 2000 ATS Control System keypad.

3.1 ATS Manual Operation



WARNING: *Lethal voltages exist inside the automatic transfer switch enclosure. Use extreme care when opening and entering these sections.*

The operator has the ability to manually transfer load by using the manual operator handle located inside the ATS cubicle. Rotating the handle enables the contacts to open and close at the same rate of speed as they would using the electrical operator. This occurs because the switching mechanism (whether electrically or manually actuated) uses the pre-loaded transfer principle that precludes the possibility of a flash-over or heavy arcing.

3.1.1 Manual Operator (Internal)

There are two types of manual operators:

- Amperes - permanently connected to the shaft of the motor by a clutch mechanism:
100 - 2000 A
- Amperes - using a removable handle connected to the gearbox at the base of the motor operator:
1600 A, 4-pole (single motor)
2000 A, 3-pole and 4-pole (single motor)
3000 and 4000 A.



NOTE: *On dual motor transfer switches, each motor has its own manual operator (see Figure 12).*

Depending upon the type of ATS (single or dual motor), select the appropriate instructions:

SINGLE MOTOR ATS

1. Turn the handle in the direction indicated on the motor housing until the closed contact set opens and the open contact set closes.
2. Release or remove the handle and store it in the proper place.
3. Close and secure the enclosure door.

DUAL MOTOR ATS

1. Observe the contact position indicators (see *Figure 14*) to determine which contact set is closed. Operate the handle for the closed contact set.
2. Turn the handle in the direction indicated on the motor housing until the contact set opens, then proceed to operate the other handle until the contact set closes in the same manner.
3. Release or remove the handle and store it in the proper place.
4. Close and secure the enclosure door.

Figure 12. Manual Operator

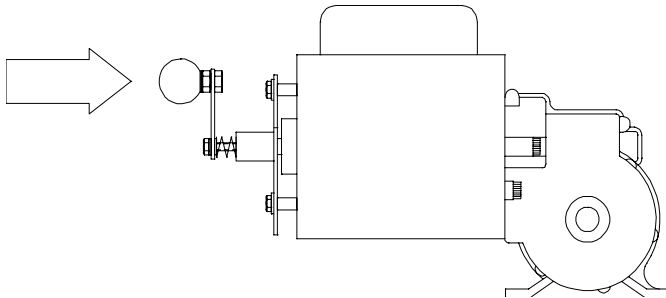

3.1.2 Manual Operator (External)

1. Access the manual operator by opening the automatic transfer switch enclosure. Other switches are provided with external manual operators (EMO) that allow easy access to the manual operator, eliminating the need to open the enclosure.



NOTE: Press the manual operator in firmly to ensure that the drive arm mechanism is engaged.

Figure 13. External Manual Operator

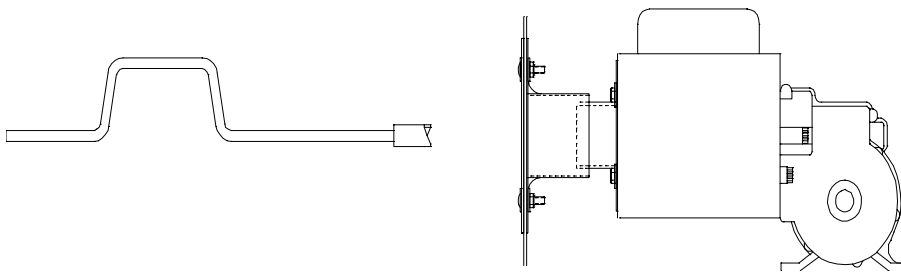

Depending upon the type of ATS (single or dual motor), select the appropriate instructions:

SINGLE MOTOR ATS

1. Turn the removable handle in the direction indicated on the enclosure door beside the external manual operator cut-out. Continue turning the handle until the closed contact set opens and the open contact set closes (see *Figure 14*).
2. Remove the handle and store it in the proper place.

DUAL MOTOR ATS

1. Determine which source is connected to the switch.
2. Turn the removable handle in the direction indicated to operate the closed contact set until the contact set opens (see *Figure 14*).
3. Turn the removable handle in the direction indicated to operate the open contact set until the contact set closes.
4. Remove the handle and store it in the proper place.

Figure 14. Contact Position Indicator

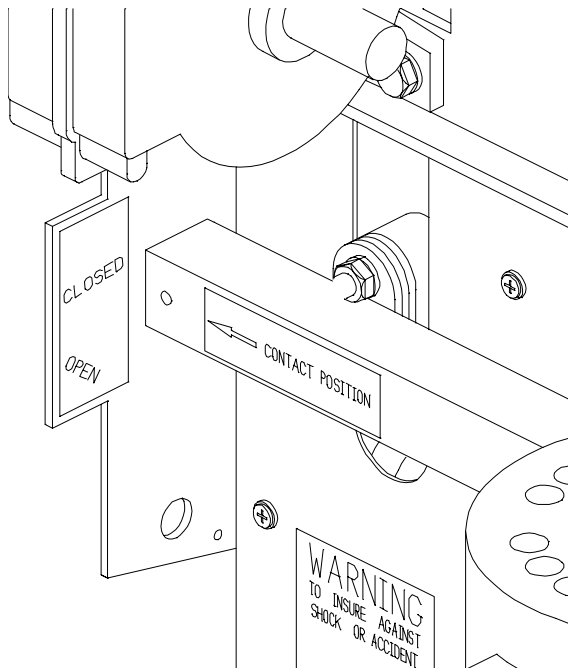

3.2 Model 2000 ATS Control System

3.2.1 Introduction

The Model 2000 operator interface allows the operator to modify and display data that is pertinent to the operation of the Model 2000 ATS Control System. Refer to **Section 1.2, Model 2000 Automatic Transfer Control System** for additional information.

Liquid Crystal Display (LCD) and Keypad

The LCD and keypad located on the front of the enclosure allow the user to communicate to the controller through a menu-driven system. The 20-character, four-line LCD is used to display the pre-programmed operator interface screens. The following sub-menus and setup screens are available from the **Main Menu** screen:

- Parameter Setup
- Control ATS
- ATS Status
- Accessory Setup
- Historical Data.



NOTE: *The ATS is pre-programmed at the factory with default parameters. Refer to the operating instructions later in this section to adjust these settings.*

3.2.2 Viewing the Main Menu Screen

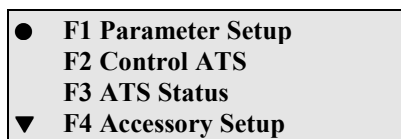

All screens are obtained through the **Main Menu** screen. This screen automatically displays when the system is powered up. If the **Main Menu** screen is not in view, press the  key repeatedly until it displays.

The bullet (•) in the top left position indicates that you are at the top page of this menu. The down arrow (⌵) located at the lower left of the menu indicates that you can access additional pages. The up arrow (⌶) located at the upper left of the menu indicates that previous pages can be accessed. The bullet (•) in the bottom left position indicates that you are at the bottom page.

Keypad Function Key Definitions

The keypad is used to set adjustable parameters, check ATS status, and control ATS operation. The following function keys are found on the 5x5 character keypad:

- **Function Keys** **F1** - **F4**
Use these keys to select a specific screen or function within a screen.
- **Command Keys** **ESC**, **ENT**
Use the **ESC** key to back up from sub-menus and to cancel new settings without making changes (provided that the **ENT** key was not pressed). Use the **ENT** key to accept new settings, confirm control functions, and confirm warnings and error messages.
- **Number Keys** **0** - **9**
Use these keys to enter new values in the setup fields.
- **Arrow Keys** **→**, **←**, **↑**, **↓**
Use the **→** and **←** keys to move forward or backward within a setup field. Use the **↑** and **↓** keys to move to the next or previous pages on multiple page screens.
- **Special Keys** **+**, **-**, *****, **/**
Use the **+** and **-** keys to change adjustable settings. The **+** key increments a value by one, and the **-** key decrements a value by one. If either key is held down continuously, a value ramps to its limit. Use the ***** key to delete entries one digit at a time. The **/** key has no function at this time.

3.2.3 Parameter Setup



The *Parameter Setup* screen allows you to modify or display the following parameter values:



- Timer Presets
- Normal Source Voltage/Frequency Failure Settings
- Emergency Source Voltage/Frequency Failure Settings
- Sync-Check Phase and Voltage Windows
- System Phase Sequence ABC
- System Phase Sequence CBA
- Exerciser Event Setup
- Time of Day Clock Setup
- Serial Communications Setup
- Reset To Factory Default Values
- Reset Exerciser Events.

To make any changes to the parameter values, ensure that the **PROGRAM MODE** switch, located on the rear left edge of the controller, is in the *Program* position.

Timer Setup

The *Timer Setup* menu allows the user to set the preset value of the following eight timers:

Timer	Range	Default	Description
AUT Timer	0-9999 Sec.	300 Sec.	The time delay for engine cooldown provides an adjustable period for unloaded engine operation. This device is generally required to return the engine to a temperature that is acceptable for shutdown. When the AUT timer expires, the engine start relay energizes, the ACC7 contact opens, and the ACC8 contact closes, signaling the emergency generator to stop.
TD1 Timer	0-9999 Sec.	3 Sec.	The time delay before engine starting overrides momentary normal source power outages. It prevents the starting of the engine generator by holding the engine start relay energized for the duration of the TD1 setting. When the timer expires, the engine start relay de-energizes, the ACC7 contact closes, and the ACC8 contact opens, signaling the emergency generator to start.  Note: Do not set the this timer to a value greater than six seconds unless an external, non-interruptible 24 Vdc source is connected to the controller power supply.
TD2 Timer	0-9999 Sec.	300 Sec.	The time delay on retransfer to normal allows the normal source to stabilize. When the timer expires, the retransfer to normal sequence begins.
TD3 Timer	0-9999 Sec.	3 Sec.	The time delay on transfer to emergency allows the emergency source to stabilize when building loads are sequenced to the emergency source. When the timer expires, the transfer to emergency sequence begins.
TDBT Timer	0-9999 Sec.	5 Sec.	The time delay before transfer in either direction provides a time delay before transfer for control of an auxiliary relay. Two sets of form 'C' contacts are available that change state prior to the TDBT delay. These contacts are generally used to signal equipment in the building that a transfer is about to occur. The contacts change state, then the TDBT time delay begins. When the timer expires, the transfer sequence continues. If ACC23B is installed, the contacts return to their original state immediately after transfer. If ACC23C is installed, the contacts return to their original state after the TDMI timer expires.  Note: The TDBT timer is only available when accessory ACC23B or ACC23C is installed.

Timer	Range	Default	Description
TDMI Timer	0-9999 Sec.	5 Sec.	<p>The time delay after transfer in either direction provides a time delay after a transfer occurs for control of an auxiliary relay. Two sets of form 'C' contacts are available that change state prior to the TDBT delay when ACC23C is installed. If ACC23A is installed, the contacts change state just prior to transfer. These contacts are generally used to signal equipment in the building that a transfer is about to occur. The contacts return to their original state after the TDMI timer expires.</p> <p> Note: The TDMI timer is only available when accessory ACC23A or ACC23C is installed.</p>
TETD Timer	0-9999 Sec.	3 Sec.	<p>The time delay to control main contact transition time on transfer to emergency allows rotating equipment's back EMF (electromotive force) to decay to an acceptable level for transfer to occur between two non-synchronized sources. On transfer to emergency, the normal source main contacts open, then the TETD timer begins. When the TETD timer expires, the emergency source main contacts close.</p> <p> Note: The TETD timer is only available on RMTD transfer switches.</p>
TNTD Timer	0-9999 Sec.	3 Sec.	<p>The time delay to control main contact transition time on retransfer to normal allows rotating equipment's back EMF (electromotive force) to decay to an acceptable level for a transfer to occur between two non-synchronized sources. On retransfer to normal, the emergency source main contacts open, then the TNTD timer begins. When the TNTD timer expires, the normal source main contacts close.</p> <p> Note: The TNTD timer is only available on RMTD transfer switches.</p>

To set the timer values:

1. Press the **F1** key on the *Main Menu* screen. The *Parameter Setup* screen displays.

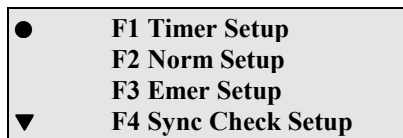

- Press the **F1** key. The *Timer Setup* screen displays.

●	F1 AUT	300 Sec
	F2 TD1	3 Sec
	F3 TD2	300 Sec
▼	F4 TD3	3 Sec

Use the **↓** key to display the second page of the *Timer Setup* screen. The following screen displays:





▲	F1 TDBT	5 Sec
	F2 TDMI	5 Sec
	F3 TETD	3 Sec
●	F4 TNTD	3 Sec



- Press the appropriate function key (**F1** - **F4**) to select timer presets. The cursor flashes in the timer value field.
- Enter a new value to change the default value shown.
- Press the **ENT** key to accept the new value or the **ESC** key to exit this screen without making changes and return to the *Parameter Setup* screen.
- Repeat Steps 3 through 5 to change additional timer presets.

Normal Setup

The *Normal Setup* screen allows the operator to preset the following values:

Value	Range	Default	Description
Undervoltage Pickup	70% to 100% Rated System Voltage	90%	The source becomes available when the monitored voltage is greater than or equal to the undervoltage pickup setting. The factory setting is used for testing and installation purposes only. Set this value to meet protection requirements of the particular load connected to this transfer switch. The value must be greater than or equal to the undervoltage dropout setting.
Undervoltage Dropout	70% to 100% Rated System Voltage	80%	The source fails when the monitored voltage is less than the undervoltage dropout setting. The factory setting is used for testing and installation purposes only. Set this value to meet protection requirements of the particular load connected to this transfer switch. The value must be less than or equal to the undervoltage pickup setting.

Value	Range	Default	Description
Overvoltage Pickup	100% to 120% Rated System Voltage	120%	<p>The source fails when the monitored voltage is greater than or equal to the overvoltage pickup setting. The factory setting is used for testing and installation purposes only. Set this value to meet protection requirements of the particular load connected to this transfer switch. The value must be greater than or equal to the overvoltage dropout setting.</p> <p> Note: This setting is only available when accessory ACC4B (normal source) and ACC26 (emergency source) are installed.</p>
Overvoltage Dropout	100% to 120% Rated System Voltage	110%	<p>The source becomes available when the monitored voltage is less than the overvoltage dropout setting. The factory setting is used for testing and installation purposes only. Set this value to meet protection requirements of the particular load connected to this transfer switch. The value must be less than or equal to the overvoltage pickup setting.</p> <p> Note: This setting is only available when accessory ACC4B (normal source) and ACC26 (emergency source) are installed.</p>
Underfrequency Pickup	70% to 100% Rated System Frequency	90%	<p>The source becomes available when the monitored frequency is greater than or equal to the underfrequency pickup setting. The factory setting is used for testing and installation purposes only. Set this value to meet protection requirements of the particular load connected to this transfer switch. The value must be greater than or equal to the underfrequency dropout setting.</p>
Underfrequency Dropout	70% to 100% Rated System Frequency	70%	<p>The source fails when the monitored frequency is less than the underfrequency dropout setting. The factory setting is used for testing and installation purposes only. Set this value to meet protection requirements of the particular load connected to this transfer switch. The value must be less than or equal to the underfrequency pickup setting.</p> <p> Note: This setting is only available when accessory ACC4B (normal source) and ACC26 (emergency source) are installed.</p>
Overfrequency Pickup	100% to 120% Rated System Frequency	120%	<p>The source fails when the monitored frequency is greater than or equal to the overfrequency pickup setting. The factory setting is used for testing and installation purposes only. Set this value to meet protection requirements of the particular load connected to this transfer switch. The value must be greater than or equal to the overfrequency dropout setting.</p> <p> Note: This setting is only available when accessory ACC4B (normal source) and ACC26 (emergency source) are installed.</p>

Value	Range	Default	Description
Overfrequency Dropout	100% to 120% Rated System Frequency	110%	<p>The source becomes available when the monitored frequency is less than the overfrequency dropout setting. The factory setting is used for testing and installation purposes only. Set this value to meet protection requirements of the particular load connected to this transfer switch. The value must be less than or equal to the overfrequency pickup setting.</p> <p> Note: This setting is only available when accessory ACC4B (normal source) and ACC26 (emergency source) are installed.</p>
Differential Pickup	5% to 20% Rated System Voltage	20%	<p>The differential voltage is the value of the difference between the phase-to-phase voltages. For example, if the phase 'A-B' voltage is 477V, the phase "B-C" voltage is 432V, and the system voltage is 480V, the differential voltage is:</p> $(477-432) / 480 = 45 / 480 = 9.4\%.$ <p>The differential voltage condition occurs when the calculated value is greater than or equal to the setting. This protection is designed to detect a single phase condition when three-phase motor loads are used. The back EMF of rotating three-phase machinery may hold the voltage of a lost phase above the conventional undervoltage dropout value. However, there is approximately 5% to 10% of a differential between phases, detectable with the voltage differential system.</p> <p> Note: This setting is only available when accessory ACC4B (normal source) and ACC26 (emergency source) are installed.</p>

To set the pickup and dropout values:

1. Press the **F1** key on the *Main Menu* screen. The *Parameter Setup* screen displays.

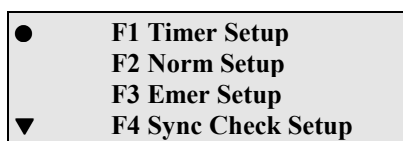

2. Press the **F2** key. The *Normal Setup* screen displays.

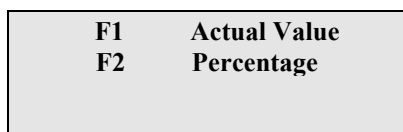

At this point you have the option of working in *Actual Value* or *Percentage* mode. The following steps (3-10), show the *Percentage* mode. If you wish to work in *Actual Value* mode, follow Steps 1 and 2, but at Step 3, press the **F1** key for actual values.

- Press the **F2** key to select **Percentage** mode. The following screen displays:

●	F1 UndV PU	90.0 %
	F2 UndV DO	80.0 %
	F3 OvrV PU	120.0 %
▼	F4 OvrV DO	110.0 %

Press the **↓** key to display the second and third pages of the screen. The following screens display:

▲	F1 UndF PU	90.0 %
	F2 UndF DO	70.0 %
	F3 OvrF PU	120.0 %
▼	F4 OvrF DO	110.0 %

▲	F1 Dif V PU	20.0 %
●		

- Press the appropriate function key (**F1** - **F4**) to select pickup or dropout values. The cursor flashes in the selected value field.
- Enter a new value to change the default value shown.



NOTE: *The decimal point is inserted automatically. It is not necessary to enter the decimal point when changing values.*

- Press the **ENT** key to accept the new value or the **ESC** key to exit this screen without making any changes.
- Repeat Steps 4 through 6 to change additional timer presets.



NOTE: *If an incorrect value is entered the following error message displays:*

●	F1 UndV PU	95.0 %
	<i>error</i>	850.0 %
	F3 OvrV PU	120.0 %
▼	F4 OvrV DO	110.0 %

*Press the appropriate function key and re-enter the correct value, or press the **ESC** key to cancel.*

Emergency Setup

Follow the same steps as *Normal Setup* except at Step 2, press the **F3** key to select *Emergency Setup*. All displays are the same.

Synchronizing (Sync) Check Setup

The Synchronizing (Sync) Check voltage window is adjustable from 5% to 20% of rated system voltage and is factory set at 20%. The sync-check phase window is adjustable from 5° to 20° and is factory set at 20°. These windows prevent transfer from one source to another unless the voltage differential and phase angle between the two sources are less than the settings.

For example, if the normal source voltage is 470 V, rated system voltage is 480 V, and emergency source voltage is 456 V, the voltage window is:

$$(470-456)/480 = 14/480 = 2.9\%.$$

To set the synchronizing check values:

1. Press the **F1** key on the *Main Menu* screen. The *Parameter Setup* screen displays.

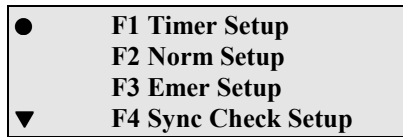

2. Press the **F4** key. The *Sync Check Setup* screen displays.



3. Press the appropriate function key **F1**, **F2** to select sync check voltage or phase. The cursor flashes in the selected value field.
4. Enter a new value to change the default value shown.
5. Press the **ENT** key to accept the new value or the **ESC** key to exit this screen without making changes and return to the *Parameter Setup* screen.

Phase Sequence Setup

The phase sequence setup is used to select either ABC or CBA system phase sequence. The phase sequence detector prevents transfer to a source if phase sequence of that source does not match the system phase sequence setting. The phase sequence detector is only used on three-phase systems.



NOTE: *The phase sequence detector is only used on three-phase systems when ACC4B (normal source) and ACC26 (emergency source) are installed.*

To set the phase sequence:

1. Press the **F1** key on the *Main Menu* screen. The *Parameter Setup* screen displays.

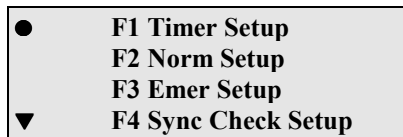

2. Press the **↓** key. The second page of the *Parameter Setup* screen displays.

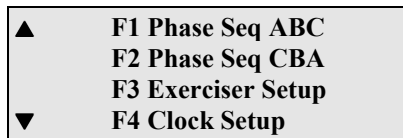

3. Press the appropriate function key **F1**, **F2** to select phase sequence ABC or CBA. One of the following two confirmation screens displays.

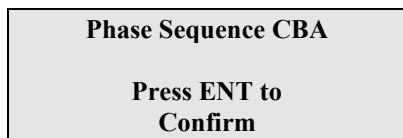
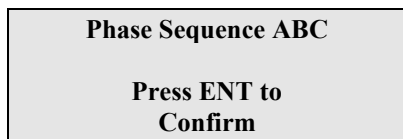

4. Press the **ENT** key to confirm, or the **ESC** key to cancel the command and return to the previous screen.

Exerciser Setup

The exerciser can automatically initiate a no-load or load test. A load test simulates a normal source power failure, starts the generator, and transfers the load to the emergency source. A no-load test starts the engine generator without a load transfer.

The exerciser is only enabled when one of the following accessories is installed:

- **ACC11A**
No-load test. Starts the engine-generator without a load transfer.
- **ACC11B**
Load test. Simulates a normal source failure, starts the engine-generator, and transfers the load to the emergency source.
- **ACC11C**
Exerciser with switch to select no-load or load test as described above.
- **ACC11D**
Exerciser with switch to select on or off. **On**, enables exerciser events. **Off**, disables exerciser events.



NOTE: Refer to Section 3.2.4, Control ATS for exerciser Load/No-Load and On/Off switch control.

The exerciser has 34 events. Each event has a unique start and stop time in 24-hour format (HH:MM). The first 10 events are used for 7-day cycles and can be programmed for the following days:

- Sunday
- Monday
- Tuesday
- Wednesday
- Thursday
- Friday
- Saturday
- Weekdays
- Everyday
- None.

Events 11-34 are calendar mode events and can be programmed for specific days of the month, or set to 00/00. Refer to **Section 3.2.4, Control ATS** for more information on controls exerciser (Override On/Off, On/Off, Load/No Load Test).

To set the exerciser values:

1. Press the **F1** key on the *Main Menu* screen. The *Parameter Setup* screen displays.

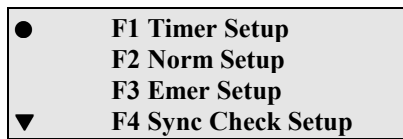

2. Press the **↓** key. The second page of the *Parameter Setup* screen displays.

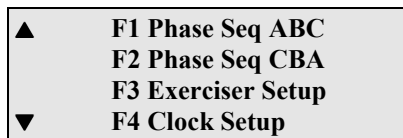

3. Press the **F3** key. The *Exerciser Setup* screen displays.

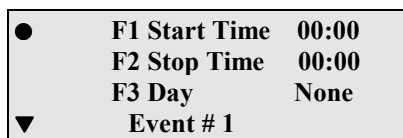

Press the **↓** key to display additional pages of the screen. The page for Event #34, shown below, is the last page of this screen.

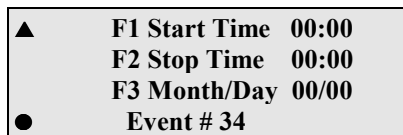

4. Press the appropriate function key **F1** - **F3** to select exerciser value presets. The cursor flashes in the selected exerciser value field.

5. Change the exerciser default values as follows:

- **Start Time, Stop Time**

Enter a new value in the field.

- **Day**

Use the **+** and **-** keys to scroll through the screen choices for events 1-10.

- **Start Time, Stop Time**

Use the **→** and **←** keys to select between the month and day field for events 11-34.
Enter a new value in the field.

- Press the **ENT** key to accept the new value or the **ESC** key to exit this screen without making changes and return to the *Parameter Setup* screen.

Clock Setup

The controller has a built-in, battery-backed, real-time clock. This clock uses the Epson 72421 chip which is accurate to approximately one second per day. Time is kept in one-second intervals, and counts up to 80 years in the future. A ten-year lithium battery maintains the time when no power is available to the controller. The clock setup display allows the operator to enter the current minutes, hours, day, month, and year.

To set the exerciser values:

- Press the **F1** key on the *Main Menu* screen. The *Parameter Setup* screen displays.

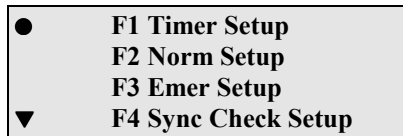

- Press the **↓** key. The second page of the *Parameter Setup* screen displays.

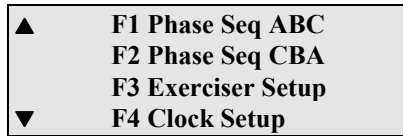

- Press the **F4** key. The *Clock Setup* screen displays.



- Press the appropriate function key **F1** - **F4** to select clock values. The cursor flashes in the selected clock value field.
- Change the clock values as follows:
 - Time, Day, Year**
Press the **+** or **-** key to increment or decrement the value shown, or enter a new value in the field.
 - Month**
Press the **+** or **-** key to scroll through the screen choices.
- Press the **ENT** key to accept the new value or the **ESC** key to exit this screen without making changes and return to the *Parameter Setup* screen.

Serial Communication Setup

An RS422/485 compatible serial port is provided for connection to the generator control switchgear or the building management system. The serial port uses ModBus™ RTU protocol. The RTU protocol is implemented in the controller for slave operation only. Refer to the *Serial Communications Manual* for detailed information about the serial communications system and a definition of RTU Protocol.



NOTE: *ModBus is a trademark of Gould Inc.*

The following describes the serial port setup for use with the Russelectric SCADA system. Included is a list of communication parameters supported by the system.



NOTE: *The default values are shown for use with the Russelectric ATS SCADA SYSTEM. Refer to the ATS SCADA SYSTEM manual for information about this program. If you are using a different SCADA system, ensure that the communication settings are correct.*

The communication parameters supported are listed below:

Value	Range	Default	Description
Baud Rate	9600, 4800, 2400, 1200	9600	A unit of transmission speed equal to the number of code elements (bits) per second.
Parity	None, Odd, Even	None	An additional non-data bit attached to a binary word to provide a check of the data integrity by making the sum of the number of ones in a word always even or odd.
Stop Bit	1, 2	1	A bit sent in asynchronous communications indicating the end of a character.
RTU Address	0 – 999	0	The communication bus can link up to 32 devices. The RTU address identifies each transfer switch on the communication bus. This number must be unique for each transfer switch.
Load Priority	0 - 999	0	Sets the transfer switch load priority when using block transfer and load shed signals via the serial communications port. It is recommended that you hard-wire the block transfer and load shed signals between the generator control switchgear and each transfer switch. These functions are also available via serial communications. Refer to the Russelectric <i>Serial Communications Manual</i> for details on using this feature. Set this field to zero if block transfer and load shed are hard-wired or not used.

To set the serial communication values:

1. Press the **F1** key on the *Main Menu* screen. The *Parameter Setup* screen displays.

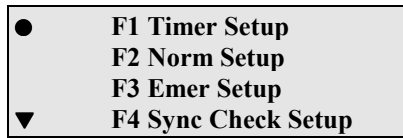

2. Press the **↓** key twice. The third page of the *Parameter Setup* screen displays.



3. Press the **F1** key. The *Serial Communication Setup* screen displays.

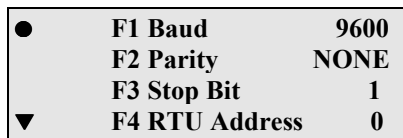

Press the **↓** key to display the second page of the screen. The following screens display:

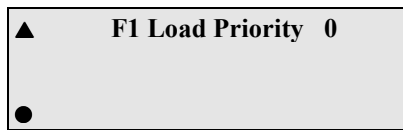

4. Press the appropriate function key **F1** - **F3** to select serial communication values. The cursor flashes in the selected serial communication value field.
5. Change the serial communication values as follows:
 - **Baud Rate, Stop Bit, RTU Address, Load Priority**
Press the **+** or **-** key to increment or decrement the value shown, or enter a new value in the field.
 - **Parity**
Press the **+** or **-** key to scroll through the screen choices.
6. Press the **ENT** key to accept the new value or the **ESC** key to exit this screen without making changes and return to the *Parameter Setup* screen.

Reset Default Values

This function is used to reset all timers, normal and emergency voltage/frequency settings, and sync-check settings, to factory default values.

To reset the default values:

1. Press the **F1** key on the *Main Menu* screen. The *Parameter Setup* screen displays.

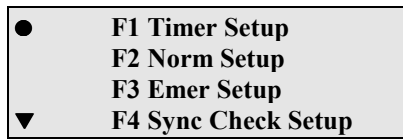

2. Press the **↓** key twice. The third page of the *Parameter Setup* screen displays.

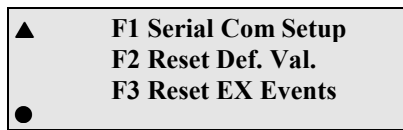

3. Press the **F2** key. The following confirmation screen displays:

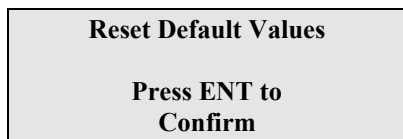

4. Press the **ENT** key to confirm, or the **ESC** key to cancel the command and return to the previous screen.

Reset Exerciser Events

This function clears all exerciser events from EEPROM memory.



WARNING: *Since you can erase all previously configured exercise periods, use this function with extreme caution.*

To reset exerciser events:

1. Press the **F1** key on the *Main Menu* screen. The *Parameter Setup* screen displays.

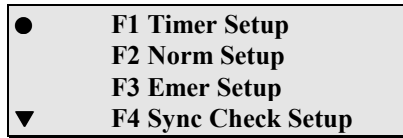

2. Press the **↓** key twice. The third page of the *Parameter Setup* screen displays.

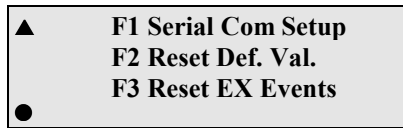

3. Press the **F3** key. The following confirmation screen displays:

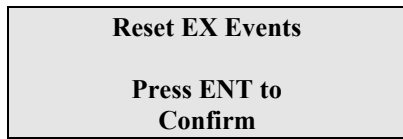

4. Press the **ENT** key to confirm, or the **ESC** key to cancel the command and return to the previous screen.

3.2.4 Control ATS

The *Control ATS* screen allows the operator to control the following transfer switch functions:

- Timer Bypass
- Load Test Start/Stop
- Bypass Block Transfer
- Commit/No Commit
- Exerciser (Override On/Off, On/Off, Load/No Load Test)
- Daylight Savings On/Off
- Maintain Emergency On/Off
- Auto/Man Transfer Mode
- Transfer to Normal
- Transfer to Emergency.

To allow the operator access to the control functions, ensure that the **PROGRAM MODE** switch, located on the rear left edge of the controller, is in the *Program* position.

Timer Bypass Setup

The *Timer Bypass* screen allows the operator to bypass any of the eight timers associated with the control system. The selected timer is bypassed for the current timing sequence.

To bypass a timer:

1. Press the **F2** key on the *Main Menu* screen. The *Control ATS* screen displays.

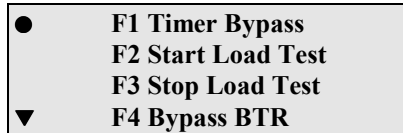

2. Press the **F1** key. The *Timer Bypass* screen displays.

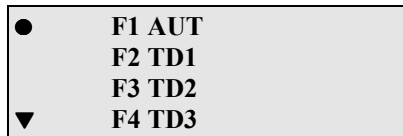

Use the **↓** key to display the second page of the *Timer Bypass* screen. The following screen displays:

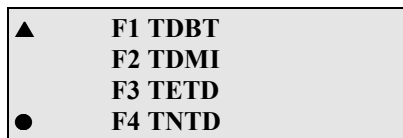

3. Press the appropriate function key (**F1** - **F4**) to select a timer to bypass. A **Press ENT** prompt displays next to the selected timer.
4. Press the **ENT** key to bypass the selected timing sequence or the **ESC** key to cancel the command. The *Control ATS* screen displays.
5. Repeat Steps 2 through 4 to bypass additional timers.

Start Load Test

This function allows the operator to simulate a normal source failure and transfer the load to the emergency source.

To initiate a load test:

1. Press the **F2** key on the *Main Menu* screen. The *Control ATS* screen displays.

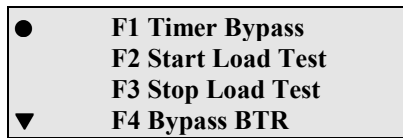

2. Press the **F2** key. The following confirmation screen displays:

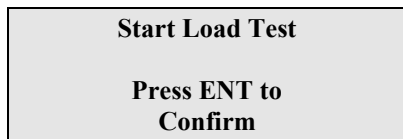

3. Press the **ENT** key to confirm, or the **ESC** key to cancel the command and return to the previous screen.

Stop Load Test

This function allows the operator to terminate a load test previously initiated by the Start Load Test function, or via serial communications interface.

To terminate a load test:

1. Press the **F2** key on the *Main Menu* screen. The *Control ATS* screen displays.

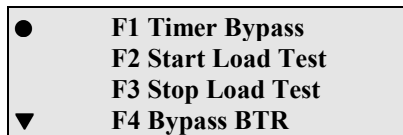

2. Press the **F3** key. The following confirmation screen displays:

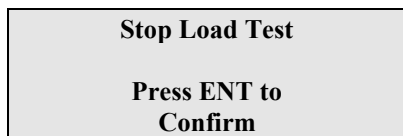

3. Press the **ENT** key to confirm, or the **ESC** key to cancel the command and return to the previous screen.

Bypass BTR

This function allows the operator to momentarily bypass the block transfer signal. When installed, the block transfer signal (BTR) is a permissive signal that allows transfer to the emergency source. This permissive signal occurs when sufficient generating capacity is available as determined by the generator control switchgear.



WARNING: *Since an engine-generator overload may occur when bypassing this signal, use extreme caution.*

To momentarily bypass the block transfer signal:

1. Press the **F2** key on the *Main Menu* screen. The *Control ATS* screen displays.

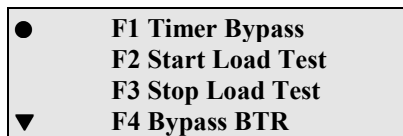

2. Press the **F4** key. The following confirmation screen displays:

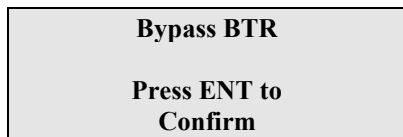

3. Press the **ENT** key to confirm, or the **ESC** key to cancel the command and return to the previous screen.

Commit

While in *Commit* mode, whenever the engine-generator starts as a result of a normal power failure, the ATS transfers the load to the emergency source. The transfer-to-emergency occurs even if normal power is restored.



NOTE: *This function is only enabled when ACC12X is installed.*

To place the system in *Commit* mode:

1. Press the **F2** key on the *Main Menu* screen. The *Control ATS* screen displays.

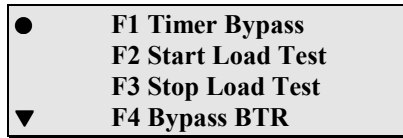

2. Press the **↓** key. The second page of the *Control ATS* screen displays.

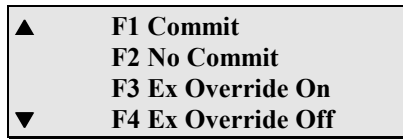

3. Press the **F1** key. The following confirmation screen displays:

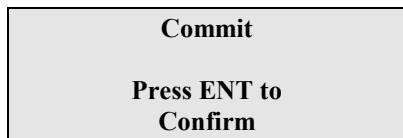

4. Press the **ENT** key to confirm, or the **ESC** key to cancel the command and return to the previous screen.

No Commit

While in *No Commit* mode, whenever the normal source fails, the TD1 timer begins timing and subsequently starts the engine-generator. In this case, the transfer switch does not transfer the load to the emergency source until it reaches its proper rated values. If the normal source returns prior to the transfer-to-emergency sequence initiation, the transfer sequence aborts and the ATS remains in the *Normal* position.



NOTE: This function is only enabled when ACC12X is installed.

To place the system in *No Commit* mode:

1. Press the **F2** key on the *Main Menu* screen. The *Control ATS* screen displays.

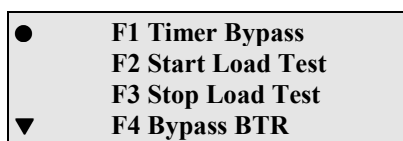

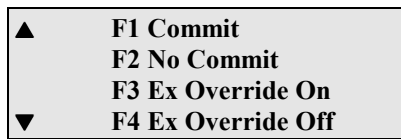

2. Press the  key. The second page of the *Control ATS* screen displays.

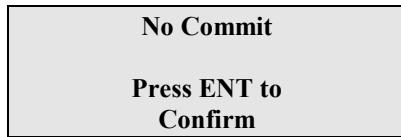

3. Press the  key. The following confirmation screen displays:



4. Press the  key to confirm, or the  key to cancel the command and return to the previous screen.

Exerciser (Ex) Override On

This function overrides the current or next exerciser event to prevent the occurrence of an exercise period. Once an exercise period ends, this function automatically resets. It is not necessary to use the *Exerciser Override Off* function to terminate this function.

To override the current or next exerciser event:

1. Press the  key on the *Main Menu* screen. The *Control ATS* screen displays.

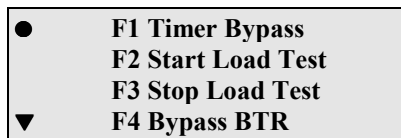

2. Press the  key. The second page of the *Control ATS* screen displays.

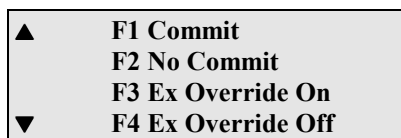

3. Press the  key. The following confirmation screen displays:

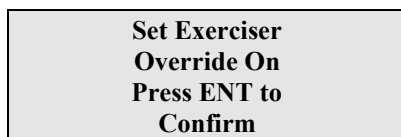

4. Press the **ENT** key to confirm, or the **ESC** key to cancel the command and return to the previous screen.

Exerciser (Ex) Override Off

This function allows the operator to turn off the *Exerciser Override* mode previously selected using the *Exerciser Override On* function, or via the serial communications interface.

To turn off the *Exerciser Override* mode:

1. Press the **F2** key on the *Main Menu* screen. The *Control ATS* screen displays.

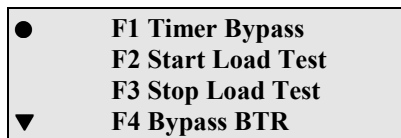

2. Press the **↓** key. The second page of the *Control ATS* screen displays.

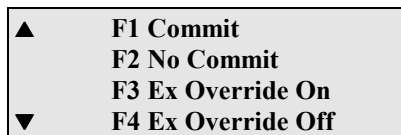

3. Press the **F4** key. The following confirmation screen displays:

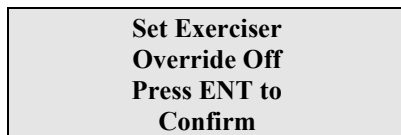

4. Press the **ENT** key to confirm, or the **ESC** key to cancel the command and return to the previous screen.

Exerciser On

This function allows the operator to enable the exerciser events.

To enable the exerciser:



NOTE: *The exerciser events must be programmed before an exerciser period can occur. This function is only enabled when ACC11D is installed.*

1. Press the **F2** key on the *Main Menu* screen. The *Control ATS* screen displays.

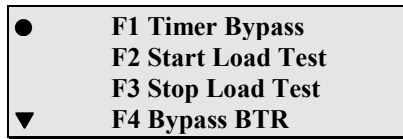

2. Press the **↓** key twice. The third page of the *Control ATS* screen displays.

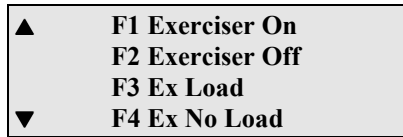

3. Press the **F1** key. The following confirmation screen displays:

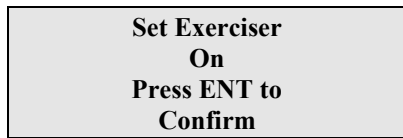

4. Press the **ENT** key to confirm, or the **ESC** key to cancel the command and return to the previous screen.

Exerciser Off

This function allows the operator to disable the exerciser events.



NOTE: *The exerciser events do not occur while the exerciser is disabled. This function is only enabled when ACC11D is installed.*

To disable the exerciser:

1. Press the **F2** key on the *Main Menu* screen. The *Control ATS* screen displays.

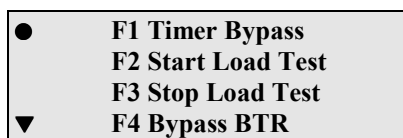

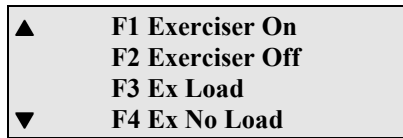

2. Press the  key twice. The third page of the *Control ATS* screen displays.

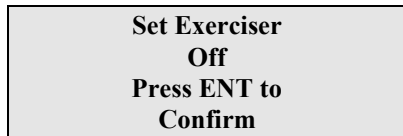

3. Press the  key. The following confirmation screen displays:



4. Press the  key to confirm, or the  key to cancel the command and return to the previous screen.

Exerciser (Ex) Load

The Exerciser (Ex) Load function allows you to set the exerciser to *Load Test* mode. During all exercise events, the ATS load is transferred to the emergency source.



NOTE: *The exerciser events must be programmed before an exerciser period can occur. This function is only enabled when ACCIIC is installed.*

To set the exerciser to *Load Test* mode:

1. Press the  key on the *Main Menu* screen. The *Control ATS* screen displays.

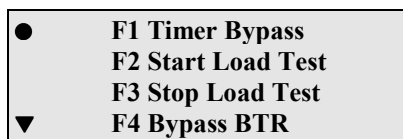

2. Press the  key twice. The third page of the *Control ATS* screen displays.

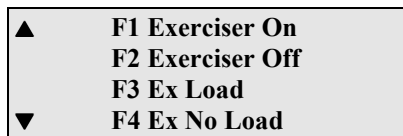

3. Press the **F3** key. The following confirmation screen displays:

**Set Exerciser
Load Test
Press ENT to
Confirm**

4. Press the **ENT** key to confirm, or the **ESC** key to cancel the command and return to the previous screen.

Exerciser (Ex) No-Load

The Exerciser (Ex) No-Load function allows you to set the exerciser mode to *No Load Test* mode. During all exercise events, the engine-generators start, but the ATS load is not transferred to the emergency source.



NOTE: *The exerciser events must be programmed before an exerciser period can occur. This function is only enabled when ACC11C is installed.*

To set the exerciser to *No-Load Test* mode:

1. Press the **F2** key on the *Main Menu* screen. The *Control ATS* screen displays.

● **F1 Timer Bypass**
F2 Start Load Test
F3 Stop Load Test
▼ **F4 Bypass BTR**

2. Press the **↓** key twice. The third page of the *Control ATS* screen displays.

▲ **F1 Exerciser On**
F2 Exerciser Off
F3 Ex Load
▼ **F4 Ex No Load**

3. Press the **F4** key. The following confirmation screen displays:

**Set Exerciser
No Load Test
Press ENT to
Confirm**

4. Press the **ENT** key to confirm, or the **ESC** key to cancel the command and return to the previous screen.

Daylight Savings On

This function allows the operator to add one hour to the system time clock to compensate for regional areas that observe daylight savings time.

To add one hour for daylight saving time:

1. Press the **F2** key on the *Main Menu* screen. The *Control ATS* screen displays.

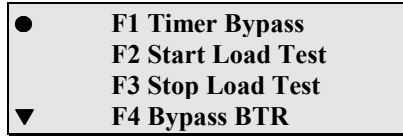

2. Press the **↓** key three times. The fourth page of the *Control ATS* screen displays.

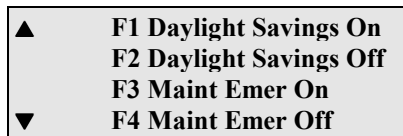

3. Press the **F1** key. The following confirmation screen displays:



4. Press the **ENT** key to confirm, or the **ESC** key to cancel the command and return to the previous screen.

Daylight Savings Off

This function allows the operator to subtract one hour from the system time clock to compensate for regional areas that observe Daylight Savings Time.

To subtract one hour for daylight saving time:

1. Press the **F2** key on the *Main Menu* screen. The *Control ATS* screen displays.

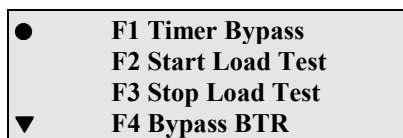

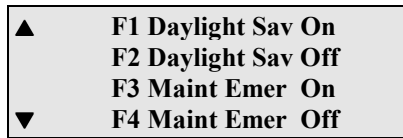

2. Press the  key three times. The fourth page of the **Control ATS** screen displays.



3. Press the  key. The following confirmation screen displays:



4. Press the  key to confirm, or the  key to cancel the command and return to the previous screen.

Maint Emer On

This function allows the operator to override the transfer switch automatic controls so that the transfer switch remains indefinitely connected to the emergency power source, regardless of the condition of the normal power source.



NOTE: *This function is only enabled when ACC5D is installed.*

To place the transfer switch in **Maint Emer On** mode:

1. Press the  key on the **Main Menu** screen. The **Control ATS** screen displays.

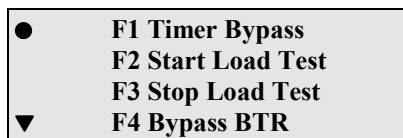

2. Press the  key three times. The fourth page of the **Control ATS** screen displays.

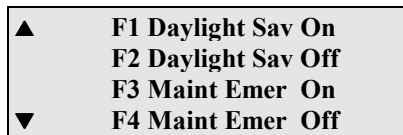

3. Press the **F3** key. The following confirmation screen displays:

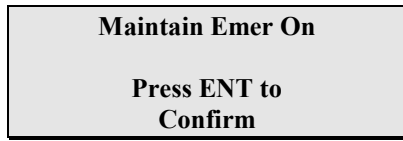

4. Press the **ENT** key to confirm, or the **ESC** key to cancel the command and return to the previous screen.



WARNING: *This function does not initiate a transfer-to-emergency.*

Maint Emer Off

This shuts off the *Maint Emer On* mode to allow for automatic retransfer-to-normal.



NOTE: *This function is only enabled when ACC5D is installed.*

To allow for automatic retransfer to normal:

1. Press the **F2** key on the *Main Menu* screen. The *Control ATS* screen displays.

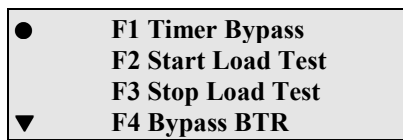

2. Press the **↓** key three times. The fourth page of the *Control ATS* screen displays.

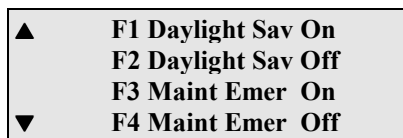

3. Press the **F4** key. The following confirmation screen displays:

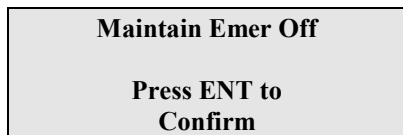

4. Press the **ENT** key to confirm, or the **ESC** key to cancel the command and return to the previous screen.

Auto Tran Mode

Enables the ATS to transfer-to-emergency and retransfer-to-normal automatically.



NOTE: *This function is only enabled when ACC12C is installed.*

To allow for automatic transfer-to-emergency and retransfer-to-normal:

1. Press the **F2** key on the **Main Menu** screen. The **Control ATS** screen displays.

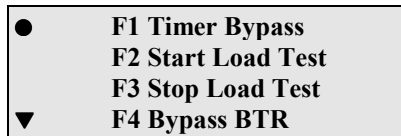

2. Press the **↓** key four times. The fifth page of the **Control ATS** screen displays.

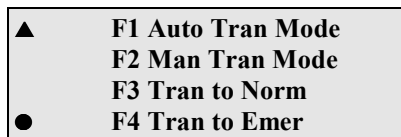

3. Press the **F1** key. The following confirmation screen displays:

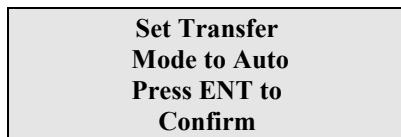

4. Press the **ENT** key to confirm, or the **ESC** key to cancel the command and return to the previous screen.

Man Tran Mode

In this mode, the ATS does not transfer to normal or emergency automatically. The appropriate push button on the accessory plate must be used.



NOTE: *This function is only enabled when ACC12C is installed.*

To allow for manual transfer-to-emergency and retransfer-to-normal:

1. Press the **F2** key on the *Main Menu* screen. The *Control ATS* screen displays.

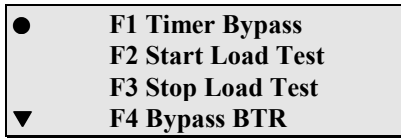

2. Press the **↓** key four times. The fifth page of the *Control ATS* screen displays.

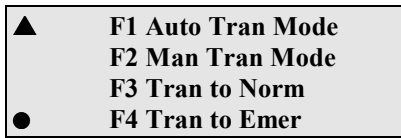

3. Press the **F2** key. The following confirmation screen displays:

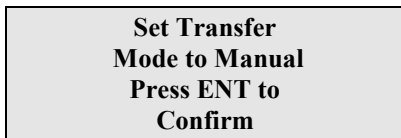

4. Press the **ENT** key to confirm, or the **ESC** key to cancel the command and return to the previous screen.

Tran to Normal

Initiates a retransfer-to-normal when ACC12C is in the *Manual* position.

To initiate a retransfer-to-normal while ACC12C is in the *Manual* position:

1. Press the **F2** key on the *Main Menu* screen. The *Control ATS* screen displays.

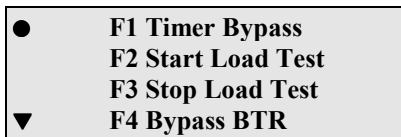

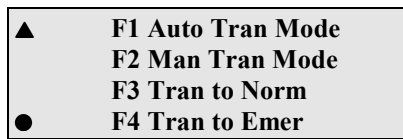

2. Press the  key four times. The fifth page of the *Control ATS* screen displays.

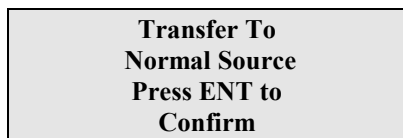

3. Press the  key. The following confirmation screen displays:



4. Press the  key to confirm, or the  key to cancel the command and return to the previous screen.

Tran to Emer

Initiates a retransfer-to-emergency when ACC12C is in the *Manual* position.

To initiate a retransfer-to-emergency while ACC12C is in the *Manual* position:

1. Press the  key on the *Main Menu* screen. The *Control ATS* screen displays.

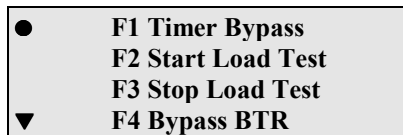

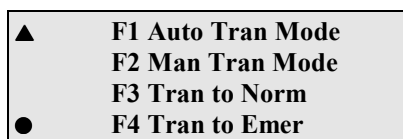

2. Press the  key four times. The fifth page of the *Control ATS* screen displays.

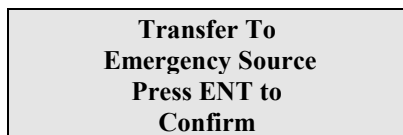

3. Press the  key. The following confirmation screen displays:



4. Press the  key to confirm, or the  key to cancel the command and return to the previous screen.

3.2.5 Viewing ATS Status

The *ATS Status* screen allows the operator to view status of the following transfer switch functions:

- System Status
- Timer Status
- Normal Source
- Emergency Source
- Synchronizing Check Status
- System Time
- Firmware Status.

System Status

The *System Status* screen allows the operator to view the status of the following transfer switch information:

Information	Status	Description
ATS Position	Norm	The ATS is in the <i>Normal</i> position.
	Off	The ATS is in the <i>Center-Off</i> position.
	Emer	The ATS is in the <i>Emergency</i> position.
Norm Source	Off	The normal power source is not available.
	On	The normal power source is available. The normal source availability is determined by the pickup, dropout, and differential settings. Refer to <i>Section 3.2.3, Parameter Setup</i> for more information on the source available settings.
Emer Source	Off	The emergency power source is not available.
	On	The emergency power source is available. The emergency source availability is determined by the pickup, dropout, and differential settings. Refer to <i>Section 3.2.3, Parameter Setup</i> for more information on the source available settings.
Engine Start	Off	The engine start relay is de-energized and signaling the engine generator to start.
	On	The engine start relay is energized and signaling the engine generator to stop. The control system is equipped with an engine start relay with two sets of contacts available for engine starting. Refer to the <i>Section 5, Accessory List</i> for more information on ACC7 and ACC8.

Information	Status	Description
Load Test	Off	The transfer switch is not in <i>Load Test</i> mode.
	Test	The transfer switch is in <i>Load Test</i> mode.
Remote Load Test	Off	The transfer switch is not in <i>Remote Load Test</i> mode.
	Test	The transfer switch is in <i>Remote Load Test</i> mode.
Exerciser	Off	None of the programmed exerciser events are active.
	On	One or more of the programmed exerciser events is active.
Exerciser Mode	Off	The EXERCISER MODE switch is off and ignores all programmed exerciser events.
	Load	The EXERCISER MODE switch is in the <i>Load Test</i> mode. When a programmed exerciser event begins, the engine generator starts. The ATS load is transferred to the emergency source.
	No-Load	The EXERCISER MODE switch is in the <i>No-Load</i> mode. When a programmed exerciser event begins, the engine generator starts. The ATS load does not transfer to the emergency source.
LTR	Off	The LTR signal from the generator control switchgear is off. The load test that was previously initiated by the LTR On function is terminated.
	On	The LTR signal from the generator control switchgear is on. The ATS is placed in <i>Load Test</i> mode.
BTR	Off	The BTR signal from the generator control switchgear is off. The ATS is not allowed to transfer to the emergency source until this signal is on, or until a bypass block transfer operation occurs.
	On	The permissive signal from the generator control switchgear allows transfer-to-emergency. This function is on when the signal from the generator control switchgear is on, or when the BTR accessory is not installed.
LSR	Off	The LSR signal from the generator control switchgear is off. The <i>Load Shed</i> mode previously initiated by the LSR On function is terminated.
	On	The LSR signal from the generator control switchgear is on. The ATS is placed in <i>Load Shed</i> mode.
PSR	Off	The peak shave function is off.
	On	The peak shave function is on. This function can be initiated through a signal from the generator control switchgear or via the serial communication interface.
Phase Sense	Three	The ATS is set up as a three-phase switch. All three phases are monitored by the voltage and frequency detection systems.
	Single	The ATS is set up as a single-phase switch. Only phase A-B is monitored by the voltage and frequency detection systems. Phase sequence detection is disabled.
System Phase Sequence	ABC	The system phase sequence is set to ABC.
	CBA	The system phase sequence is set to CBA.

Information	Status	Description
Normal Phase Sequence	ABC	The normal source phase sequence is ABC.
	CBA	The normal source phase sequence is CBA.
Emergency Phase Sequence	ABC	The emergency source phase sequence is ABC.
	CBA	The emergency source phase sequence is CBA.
Area Protection	Off	The area protection input is open.
	On	The area protection input is closed.
Commit	Off	When the normal power source fails, the TD1 timer begins and subsequently starts the engine generator. In this case, the transfer switch does not transfer the load to the emergency source until it reaches proper rated values. If the normal source returns prior to the initiation of the transfer-to-emergency sequence, the transfer sequence aborts, and the ATS remains connected to the normal power source.
	On	Whenever the engine generator starts as a result of a normal failure, the ATS transfers the load to the emergency source. The transfer-to-emergency occurs even if the normal power is restored. However, the transfer switch does not transfer to the Emergency position after an outage if utility power returns prior to the TD1 time delay. In this case, the ATS remains in the Normal position.
Motor	Single	The ATS is a single motor transfer switch.
	Dual	The ATS is a dual motor transfer switch.
DST	Off	One hour has been subtracted from the system time clock to compensate for daylight savings time.
	On	One hour has been added to the system time clock to compensate for daylight savings time.
ATS Mode	Auto	The transfer switch is in Automatic operation mode.
	Manual	The transfer switch is in Manual operation mode.
Maintain Emergency	Off	The transfer switch controls allow for automatic retransfer-to-normal.
	On	The transfer switch remains connected to the emergency power source regardless of the condition of the normal or emergency power sources.

To view the transfer switch system status information:

1. Press the **F3** key on the *Main Menu* screen. The *ATS Status* screen displays.

●	F1 System Status
	F2 Timer Status
	F3 Normal Source
▼	F4 Emergency Source

2. Press the **F1** key. The *System Status* screen displays.

●	ATS Position	Norm
	Norm Source	On
	Emer Source	Off
▼	Engine Start	Off

Use the **↓** key to display additional pages of the *System Status* screen. The following screens display:

▲	Load Test	Off
	RemLoad Test	Off
	Exerciser	Off
▼	Ex Mode	Load

▲	LTR	Off
	BTR	Off
	LSR	Off
▼	PSR	Off

▲	Phase Sense	Three
	Sys Pha Seq	ABC
	Norm Pha Seq	ABC
▼	Emer Pha Seq	ABC

▲	Area Prot	Off
	Commit	Off
	Motor	Dual
▼	DST	Off

▲	ATS Mode	Auto
	Tran Mode	Norm
	Sync Check	Off
●	Main Emer	Off

3. Press the **ESC** key to return to the *ATS Status* screen.

Timer Status

The *Timer Status* screen allows the operator to view the status of the transfer switch timers. The first column of numbers represents the preset value, and the second column represents the accumulated value.

To view the transfer switch timer status information:

1. Press the **F3** key on the *Main Menu* screen. The *ATS Status* screen displays.

●	F1 System Status
	F2 Timer Status
	F3 Normal Source
▼	F4 Emergency Source

2. Press the **F2** key. The *Timer Status* screen displays.

●	AUT = 300	0 Sec
	TD1 = 3	0 Sec
	TD2 = 300	0 Sec
▼	TD3 = 3	0 Sec

Use the **↓** key to display the second page of the *Timer Status* screen. The following screen displays:

▲	TDBT = 0	0 Sec
	TDMI = 0	0 Sec
	TETD = 3	0 Sec
●	TNTD = 3	0 Sec

3. Press the **ESC** key to return to the *ATS Status* screen.

Normal Source

The *Normal Source* screen allows the user to view the status of the normal source phase-to-phase voltages and the normal source frequency.

To view the transfer switch normal status information:

1. Press the **F3** key on the *Main Menu* screen. The *ATS Status* screen displays.

●	F1 System Status
	F2 Timer Status
	F3 Normal Source
▼	F4 Emergency Source

- Press the **F3** key. The *Normal Source* screen displays.

Norm	∅A-∅B	480 V
Norm	∅B-∅C	480 V
Norm	∅C-∅A	480 V
Norm Freq		60.0 Hz

- Press the **ESC** key to return to the *ATS Status* screen.

Emergency Source

The *Emergency Source* screen allows the user to view the status of the emergency source phase-to-phase voltages and the emergency source frequency.

To view the transfer switch emergency status information:

- Press the **F3** key on the *Main Menu* screen. The *ATS Status* screen displays.

●	F1 System Status
	F2 Timer Status
	F3 Normal Source
▼	F4 Emergency Source

- Press the **F4** key. The *Emergency Source* screen displays.

Emer	∅A-∅B	480 V
Emer	∅B-∅C	480 V
Emer	∅C-∅A	480 V
Emer Freq		60.0 Hz

- Press the **ESC** key to return to the *ATS Status* screen.

Sync Check Status

The *Synchronizing Check Status* screen allows the user to view the voltage differential and phase angle between two sources.

To view the transfer switch synchronizing check status information:

- Press the **F3** key on the *Main Menu* screen. The *ATS Status* screen displays.

●	F1 System Status
	F2 Timer Status
	F3 Normal Source
▼	F4 Emergency Source

2. Press the  key. The second page of the *ATS Status* screen displays.

▲	F1 Sync Chk Status
	F2 System Time
●	F3 Firmware Status

3. Press the  key. The *Synchronizing Check Status* screen displays.

●	Phase Ang	180°
	Volt Win	100%
	Norm Freq	60.0 Hz
▼	Emer Freq	60.0 Hz

4. Press the  key. The second page of the *Synchronizing Check Status* screen displays.

▲	Norm Volts	480 V
	Emer Volts	480 V
●	Slip Rate	60.0 Hz

5. Press the  key to return to the previous level on the *ATS Status* screen.

System Time

The *System Time* screen displays the current time, day, month, and year.

To view the system time status information:

1. Press the  key on the *Main Menu* screen. The *ATS Status* screen displays.

●	F1 System Status
	F2 Timer Status
	F3 Normal Source
▼	F4 Emergency Source

2. Press the  key. The second page of the *ATS Status* screen displays.

▲	F1 Sync Chk Status
	F2 System Time
●	F3 Firmware Status

3. Press the **F2** key. The *System Time* screen displays.

Time	09:45:07
Day 10	Saturday
Month	July
Year	1997

4. Press the **ESC** key to return to the *ATS Status* screen.

Firmware Status

The *Firmware Status* screen displays the type and revision level of the installed firmware.

To view the firmware status information:

1. Press the **F3** key on the *Main Menu* screen. The *ATS Status* screen displays.

●	F1 System Status
	F2 Timer Status
	F3 Normal Source
▼	F4 Emergency Source

2. Press the **↓** key. The second page of the *ATS Status* screen displays.

▲	F1 Sync Chk Status
	F2 System Time
	F3 Firmware Status
●	

3. Press the **F3** key. The *Firmware Status* screen displays.

Program for use with Standard ATS Firmware Rev. X.XX

4. Press the **ESC** key to return to the *ATS Status* screen.

3.2.6 Accessory Setup

The *Accessory Setup* screen allows you to install and de-install optional control accessories.



NOTE: For a complete list of Accessory items, refer to Section 5, Appendix in this manual.

To install or de-install an accessory:

1. Press the **F4** key on the *Main Menu* screen. The *Password* screen displays.

Enter Password
Press ENT to Cont.
Press ESC to Exit

2. Enter **3 0 2 0** in the flashing password field.
3. Press the **ENT** key to confirm the password and continue, or the **ESC** key to return to the *Main Menu* screen. If you press the **ENT** key and continue the *Accessory Setup* screen displays.

●	F1 ACC1DX	OUT
	F2 ACC4B	OUT
	F3 ACC5A	IN
▼	F4 ACC5B	OUT



NOTE: The words **In** and **Out** indicate if the accessory is currently installed or not installed.

Use the **↓** and **↑** keys to scroll through additional pages of the *Accessory Setup* screen.

4. Press the corresponding function key **F1** - **F4** to select an accessory to install or de-install. The following screen displays:

F1 Install
F2 De-Install

- 5a. Press the **F1** key to install the selected accessory. The following confirmation screen displays:



OR:

- 5b. Press the **F2** key to remove the selected accessory. The following confirmation screen displays:



6. Press the **ENT** key to accept change or the **ESC** key to exit this screen without making changes and return to the previous screen.
7. After pressing the **ENT** key on the confirm menu, the screen returns to the *Accessory Setup* screen. Confirm that the accessory install status (IN/OUT) is correct. Press the **ESC** key to return to the *Accessory Setup* screen.
8. Repeat Steps 4 - 7 to install or de-install additional accessories.

3.2.7 Historical Data

Display Historical Data

The controller logs the most recent ten transfer events. Event number one is the most recent and event number ten is the oldest. Each event contains a date and time stamp along with an information field.

The information field is a numeric expression that is the sum of the values specifying the type and cause of the transfer. The Display Historical Data screen allows the user to view the following values:

Group	Numeric Value	Acronym	Description
1	1	TTN	Transfer to Normal
1	2	TTE	Transfer to Emergency
2	4	UV	Undervoltage
2	8	OV	Overvoltage
2	16	UF	Underfrequency
2	32	OF	Overfrequency
2	64	VD	Voltage Differential
2	128	PR	Phase Reversal
3	256	LTH	Load Test Hardware (via physical LOAD TEST switch).
3	512	EX	Exerciser
3	1024	RLT	Remote Load Test
3	2048	LTS	Load Test Software (via membrane switch or SCADA system).
3	4096	PSR	Peak Shave
3	8192	AP	Area Protection
3	16384	CTT	Commit to Transfer
3	32768	LSR	Load Shed



NOTE: *The first group of numeric values (1, 2) describes the direction of the transfer, the second group of numeric values (4, 8, 16, 32, 64, 128) describes the normal or emergency voltage sensing failure, and the third group of numeric values (256, 512, 1024, 2048, 4096, 8192, 16384, 32768) describes user invoked transfer functions.*

The numeric value displayed in the Info field in the **Historical Data** screen is the sum of one number from Group 1, and one or more numbers from Groups 2 and 3.

To interpret the numeric value in the Info field, perform the following calculation:

1. Determine the largest number in the table that can be subtracted from the number in the Info field.
2. Subtract this number and continue to repeat these steps until the remainder is zero.
3. Compare these numbers to those in the table to interpret the numeric value.

For example:

If the number in the Info field is 258, then largest number in the table that can be subtracted is 256. The remainder is two. Next, subtract the largest number in the table from the remainder. When you subtract two from two, the remainder is zero. By comparing these numbers to those in the table, you can see that the number two indicates that a transfer-to-emergency occurred, and the number 256 indicates that the transfer was initiated via load test hardware.

To display the historical data:

1. Press the  key on the *Main Menu* screen. The second page of the *Main Menu* screen displays.

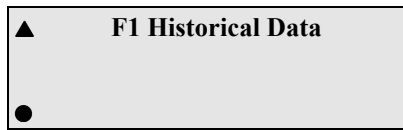



2. Press the  key on the *Main Menu* screen. The *Historical Data* screen displays.

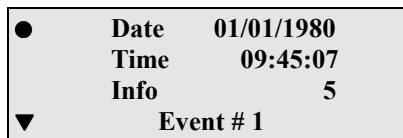

3. Press the  key. The first page of the *Display Historical Data* screen displays.



Use the  key to display the additional nine pages of the *Display Historical Data* screen.

4. Press the  key to return to the *Historical Data* screen.

Display Source Data

The source data displays, in seconds, the amount of time the normal and emergency sources are available, the amount of time each source was connected to the load, and the number of transfer operations to that source.

To display the source data:

1. Press the  key on the *Main Menu* screen. The second page of the *Main Menu* screen displays.



2. Press the  key on the *Main Menu* screen. The *Historical Data* screen displays.



3. Press the  key. The *Display Source Data* screen displays.

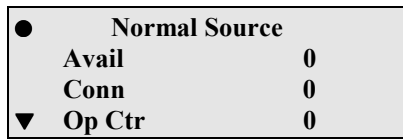

Use the  key to display the second page of the *Display Source Data* screen.

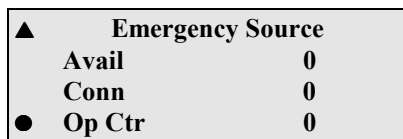

4. Press the  key to return to the *Historical Data* screen.

Record Reset

This function provides a means to clear the historical data event fields and source data fields.

To clear the historical data and source data event fields:

1. Press the  key on the *Main Menu* screen. The second page of the *Main Menu* screen displays.





2. Press the  key on the *Main Menu* screen. The *Historical Data* screen displays.

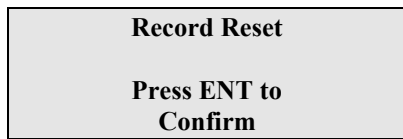

3. Press the  key. The following confirmation screen displays.



4. Press the  key to confirm the reset or the  key to return to the *Historical Data* screen without clearing the event data fields.

3.3 Optional Accessory Plate Status and Operation

Figure 15. Optional Accessory Plate

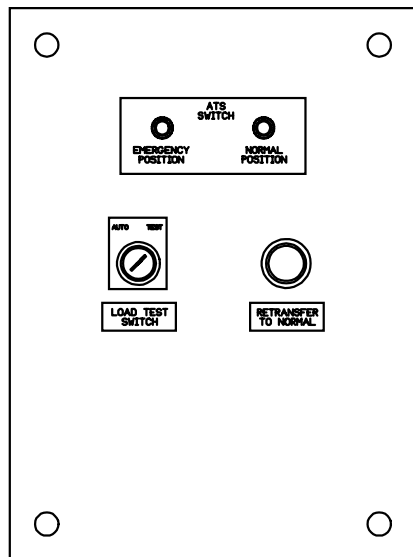

The optional accessory plate provides a separate set of ATS status LEDs and control switches to initiate various secondary functions of the control system. This plate is used in conjunction with the automatic controller. The accessory plate may contain one or more of the following devices.

3.3.1 Annunciation Devices

Alarm Horn

The alarm horn sounds an audible alarm when the ATS is in the *Emergency* position.

Status LEDs

The status LEDs indicate various status points and provide the operator with a highly visible indication of pertinent events during system operation. The accessory plate may contain the following LEDs:

LED	Description
Alarm Horn Silenced	Illuminates when the alarm horn is silenced.
Emergency Position	Illuminates when the ATS is in the <i>Emergency</i> position.
Emergency Power Available	Illuminates when the emergency source is available.
Normal Position	Illuminates when the ATS is in the <i>Normal</i> position.
Normal Power Available	Illuminates when the normal source is available.
Not In AUTO	Illuminates when the ATS is in the <i>Manual</i> operation mode.

3.3.2 Control Switches and Push Buttons

The following switches and push buttons are generally located externally on the accessory plate:

ALARM HORN SILENCE (ACC28)

This push button silences the alarm horn and illuminates the Alarm Horn Silenced LED.

BLOCK TRANSFER-TO-EMERGENCY OVERRIDE (BTRK)

This switch allows the operator to momentarily bypass the block transfer signal. When installed, the block transfer signal (BTR) is a permissive that allows transfer to the emergency source. This permissive signal occurs when sufficient generating capacity is available as determined by the generator control switchgear.



WARNING: Since an engine-generator overload could occur, use extreme caution when bypassing this signal.

To bypass the BTR signal, momentarily turn this switch to the *Transfer* position. This initiates the transfer-to-emergency sequence.

BYPASS TIME DELAY ON RETRANSFER-TO-NORMAL (TD2) (ACC6B)

This accessory provides a means to bypass the retransfer-to-normal timer (TD2). Operate this push button momentarily to bypass the TD2 timer and initiate the retransfer-to-normal sequence.

EXERCISER MODE SELECTOR (ACC11C)

This switch is used to set the exerciser to *Load* or *No-Load* mode.

- ***Load***
Allows an operator to set the exerciser to *Load Test* mode. The ATS load transfers to the emergency source during all exercise events.
- ***No-Load***
Allows an operator to set the exerciser to *No-Load Test* mode. The engine-generator starts, but the ATS load does not transfer to the emergency source during all exercise events.

EXERCISER MODE SELECTOR (ACC11D)

This switch is used to enable or disable exerciser.

- ***On***
Enables the exerciser for *Load Test* mode. The ATS load transfer to the emergency source during all exercise events.
- ***Off***
Disables the exerciser for all exerciser events.

LOAD TEST (ACC5A)

This switch allows the operator to simulate a normal source failure.

- ***Test***
This position simulates a normal source failure and transfers the load to the emergency source.
- ***Auto***
This position terminates the load test.

MAINTAIN EMERGENCY POSITION (ACC5D)

There are two positions available for operation:

- ***Auto***
This function returns the ATS controls to allow automatic retransfer to normal.
- ***Maintain Emergency***
This function allows the operator to override the ATS automatic controls so that the ATS remains indefinitely connected to the emergency power source, regardless of the condition of the normal power source.

RETRANSFER-TO-NORMAL (ACC6A)

When this accessory is provided, the ATS does not retransfer-to-normal automatically unless the engine generator fails while normal power is available. Operate this push button momentarily to initiate the retransfer to normal sequence.

RETRANSFER-TO-NORMAL (ACC6E)

This push button initiates a retransfer-to-normal when the **TRANSFER MODE SELECTOR** switch (ACC12B) is in the ***Manual*** position.

RETRANSFER-TO-NORMAL (ACC6F)

This push button initiates a retransfer-to-normal when the **TRANSFER MODE SELECTOR** switch (ACC12C) is in the ***Manual*** position.

TRANSFER MODE SELECTOR (ACC12B)

This switch allows the operator to choose between a manual or fully automatic retransfer of loads to the normal source.

- ***Automatic***
The ATS automatically retransfers-to-normal.
- ***Manual***
The ATS does not retransfer-to-normal automatically unless the engine-generator fails while normal power is available. The **RETRANSFER-TO-NORMAL** push button (ACC6E) must be operated to initiate a retransfer.

TRANSFER MODE SELECTOR (ACC12C)

There are two positions available for operation:

- ***Automatic***
The ATS operates as an automatic transfer switch. Transfer-to-emergency and retransfer-to-normal is automatically initiated.
- ***Manual***
The ATS does not retransfer-to-normal automatically. The **RETRANSFER-TO-NORMAL** push button (ACC6F) must be operated to initiate a retransfer.

The ATS does not transfer-to-emergency automatically. The **TRANSFER-TO-EMERGENCY** push button (ACC6G) must be operated to initiate a transfer.

TRANSFER MODE SELECTOR (ACC12X)

This switch allows the operator to select either ***Commit*** or ***No Commit*** operation.

- ***Commit Position (On)***
The ATS automatically transfers the load to the emergency source. This transfer occurs even if normal power is restored. However, the ATS does not transfer to the ***Emergency*** position after an outage if utility power returns prior to the TD1 time delay. In this case, the ATS remains in the ***Normal*** position.
- ***No Commit (Off)***
When the normal source fails, the TD1 timer begins timing and subsequently starts the engine generator. In this case, the ATS does not transfer the load to the emergency source until it reaches its proper rated values. If the normal source returns prior to the initiation of the transfer-to-emergency sequence, the transfer sequence aborts, and the ATS remains in the ***Normal*** position.

TRANSFER-TO-EMERGENCY (ACC6F)

This push button initiates a transfer-to-emergency when the **TRANSFER MODE SELECTOR** switch (ACC12C) is in the ***Manual*** position.

4

Troubleshooting & Maintenance

4.0 General

This section describes how to service and maintain the Automatic Transfer Switch (ATS). It is intended to be a guide for maintenance technicians. It contains a troubleshooting chart, instructions, and appropriate warnings where necessary. Also included is a sample Start-up Checklist used by Field Service personnel.

The ATS does not require regular maintenance other than periodic cleaning and visual inspection for contact condition, components, and wiring. The motor operators are lubricated, and the gear cases are packed and sealed with grease at the factory. This is done to eliminate the need for further lubrication. Occasionally, you may need to change a time delay setting.

4.1 Preventive Maintenance



WARNING: *Lethal voltages exist inside the automatic transfer switch enclosure. Use extreme care when opening and entering these sections.*

Wiring and Components

STEPS:

Preliminary step - Check equipment service records for previous problems.

1. Perform visual inspections of all wiring and connections for signs of tracking, overheating, and insulation deterioration.
2. Check and tighten where necessary, all control circuit wiring terminals.
3. Check manual switches for free movement and contact continuity.
4. Check all time delay settings and adjust to the customer specifications.
5. Check condition of main, arcing, and auxiliary contacts.
6. Check all common and ground wires. Measure and record resistance to ground readings.
7. Check lug connections and mounting insulator bolts.
8. Meggar test for grounds or leakage.
9. Perform a load test to verify proper transfer operation.
10. Perform relative infrared heat scan on all contacts.

Enclosure

STEPS:

1. Wipe down and touch up minor exterior scratches.
2. Clean interior of enclosure and remove accumulated dust and/or dirt.
3. Check door enclosure, locking bars, and mechanism for proper operation.

Miscellaneous

STEPS:

1. Record findings of the inspection. Note corrective action to be taken.
2. Report unsafe conditions.
3. Report recommendations for replacement of major components.

ATS Troubleshooting Chart*



WARNING

EXERCISE EXTREME CAUTION WHILE WORKING WITHIN THE TRANSFER SWITCH SECTION. LETHAL VOLTAGES ARE PRESENT.

SYMPTOM	PROBABLE CAUSE	CORRECTIVE ACTION
Transfer switch does not transfer from normal to emergency.	1. Emergency source not available.	1. Check emergency source feeder breaker or disconnect switch.
	2. Engine-generator did not start.	2. Check engine start contacts, circuitry and wires.
		Engine-generator in Off position; place in Auto position.
3. Check the emergency power available light (EPA) located on the side of the microprocessor.	3. If the light is on, consult the Russelectric factory. If the light is out, ensure that the corrective actions in 1 and 2 above have been checked. Consult the Russelectric factory.	
Transfer switch does not transfer from emergency to normal.	4. Check the transfer to emergency light (TTE) on the side of the microprocessor.	4. If the light is flashing, the time delay on the transfer-to-emergency is timing. If the light is steady, consult the Russelectric factory.
	5. Normal source not available.	5. Check normal source feeder breaker or disconnect switch.
	6. Check the normal power available light (NPA) on the side of the microprocessor.	6. If the light is on, consult the Russelectric factory. If the light is out, ensure that corrective action #5 has been checked. Consult the Russelectric factory.
	7. Check the transfer-to-normal light (TTN) on the side of the microprocessor.	7. If the light is flashing, the time delay on the transfer-to-normal is timing. If the light is steady, consult the Russelectric factory.
	8. Check the LOAD TEST SWITCH.	8. Ensure that the LOAD TEST SWITCH is not in the Load Test position.

*This chart covers a basic transfer switch. Optional accessories may contribute to probable causes.

Startup Checklist for Model 2000 Automatic Transfer Switches for _____, Shop Order Number

Serial # _____ Model # _____ Voltage _____ Amps _____ Freq. _____ Customer I.D.

Initial Step: Record the following serial numbers/revisions using the information from the components

Processor # _____ Processor Firmware Revision # _____ Normal Attenuator Board # _____

Emergency Attenuator Board # _____

Microprocessor Power Supply and Motor Control Board # _____

PROCEDURE

INITIALS/DATE

Perform the following procedure, and place your initials and current date in the right hand column.

1. **Verify all wiring:**

Plug-in Connectors _____

Control Circuit Wiring Terminals _____

2. **Verify the operation of the following LED indicators**

(located on the front of the controller):

CPU Running _____

ATS in Normal Position _____

ATS in Emergency Position _____

3. **Verify the operation of the following status LED's**

(located on the right side of the controller):

(TSN) Normal Position Indicator _____

(NPA) Normal Power Available _____

(TTN) Transfer to Normal (TD2, TDBT, TNTD timing) _____

(ESR) Engine Start Relay Status (TD1 and AUT timing) _____

PROCEDURE

INITIALS/DATE

(TSE) Emergency Position Indicator _____

(EPA) Emergency Power Available _____

(TTE) Transfer to Emergency (TD3, TDBT, TETD timing) _____

(BTR/LSR) Block Transfer and Load Shed Status _____

**Startup Checklist for
Model 2000 Automatic Transfer Switches
for _____, Shop Order Number**

4. **PARAMETER SETUP:**

Timer Setup:

Record the following preset values of the eight timers associated with the control system:

AUT ____ Sec TD1 ____ Sec TD2 ____ Sec TD3 ____ Sec _____

TDBT ____ Sec TDMI ____ Sec TETD ____ Sec TNTD ____ Sec _____

5. **Verify the following functions:**

Engine start signal _____

Transfer to emergency _____

Transfer to normal _____

Load shed _____

Block transfer _____

Bypass block transfer _____

Load test _____

Bypass to normal (RTB Only) _____

Bypass to emergency (RTB Only) _____

Isolation (RTB Only) _____

Sneak Circuit Logic _____

**Startup Checklist for
Model 2000 Automatic Transfer Switches
for _____, Shop Order Number**

PROCEDURE

INITIALS/DATE

6. **Verify the following annunciation:**

Emergency Power Available

Normal Power Available

Normal Position

Emergency Position

Bypass Normal (RTB Only)

Bypass Emergency (RTB Only)

Switch Isolated (RTB Only)

7. **Normal Voltage**

A-B ____ B-C ____ C-A ____

Rotation _____

8. **Emergency Voltage**

A-B ____ B-C ____ C-A ____

Rotation _____

Hz _____

9. Review accessory sheet and ensure all items have been tested and inspected.

Startup Checklist for Model 2000 Automatic Transfer Switches for _____, Shop Order Number

PROCEDURE

INITIALS/DATE

10. *Procedures for Testing the load shed/block transfer logic.*

A. **Block Transfer**

- 1. Ensure that all interconnect wiring to switchgear has been tested.
- 2. This ATS is priority number _____.
- 3. Place the ATS in the *Test* position.
- 4. Do not allow any engines to close to the emergency bus.
- 5. Allow (1) generator to close to the emergency bus.

Note: Ensure ATS does not transfer to the emergency bus.

- 6. Allow 2nd generator to close to the bus. The ATS should only transfer until the appropriate number of engines are on-line to match its priority sequence.

B. **Block Transfer Bypass**

- 1. Place the ATS in the *Test* position.
- 2. Allow (1) generator to close the emergency bus.

Note: Ensure ATS does not transfer.

- 3. Operate BYPASS BLOCK TRANSFER switch on accessory plate. ATS will transfer to the emergency source with only (1) generator on the bus.

**Startup Checklist for
Model 2000 Automatic Transfer Switches
for _____, Shop Order Number**

PROCEDURE

INITIALS/DATE

C. Load Shed

1. Place the ATS in the Test position and allow all generators to start and transfer to the emergency bus.
2. Start shutting down the generators one at a time until the ATS transfers back to the utility source. The ATS should only transfer back to normal when there is less than the appropriate number of generators on the bus to match its priority.
3. The load shed condition will override the manual block transfer override as mentioned in (B3).

5 Appendix

ACCESSORY LIST

NOTE: *INTERNAL* refers to the internal feature of the Microprocessor. *EXTERNAL* refers to a separate feature of the Microprocessor that requires additional hardware components mounted on the transfer switch.

DEVICE	FUNCTION	TYPE
STD	Voltage and frequency sensing of normal source. Under voltage sensing (programmable range: 70%-100%) factory set at 90% pickup, 80% dropout. Under frequency sensing (programmable range: 70%-100%) factory set at 90% pickup, 70% dropout. (Internal)	Standard
STD	Voltage and frequency sensing of emergency source. Under voltage sensing (programmable range: 70%-100%) factory set at 90% pickup, 80% dropout. Under frequency sensing (programmable range: 70%-100%) factory set at 90% pickup, 70% dropout. (Internal)	Standard
1d	TD1 Time delay to override momentary normal source power outages to delay engine start signal and transfer switch operation. Programmable 0-9999 seconds. Factory set at 3 seconds. A time setting > six seconds requires an external 24 Vdc, 1 Amp power supply. (Do not use with a two-utility source switch). (Internal)	Standard
1dx	TD1 Time delay to override momentary normal source power outages to delay transfer switch operation. Programmable 0-9999 seconds. Factory set at 3 seconds. A time setting > six seconds requires an external 24 Vdc, 1 Amp power supply. (Use with a two-utility source switch) (Internal)	Standard
2a	TD2 Time delay on re-transfer to normal. Programmable 0-9999 seconds. Factory set at 300 seconds. (Do not use with ACC.6a) (Internal)	Standard
2b	TD3 Time delay on transfer-to-emergency. Programmable 0-9999. Factory set at 3 seconds. (Internal)	Standard
2c	TD1 Time delay to override momentary normal source power outages to delay engine start signal and transfer switch operation air diaphragm. Factory set at 3 seconds. (Adjustable 1-300 seconds). (Use when an external power supply is not available.) Program Accessory 1d to 0 seconds - Do not use with a two-utility source switch). You must use external AUT with external TD1. Set both internal TD1 and AUT to 0 seconds. (External)	Optional
2d	TNTD TETD Time delay to control contact transition time on transfer to either source. Programmable 0-9999 seconds. Factory set at 3 seconds. (Used on dual motor switches) (Do not use with ACC.27a or 27b) (Internal)	Standard

2e	AUT	Engine overrun to provide unloaded engine operation after re-transfer to normal. Programmable 0-9999. Factory set at 300 seconds. (Internal)	Standard
4b	ACC4b	Over voltage sensing of the normal source (programmable range: 100%-120%) factory set at 120% pickup, 110% dropout. Over frequency sensing (programmable range: 100%-120%) factory set at 120% pickup, 110% dropout. Voltage differential between phases (programmable range: 5%-20%) factory set at 20%. Underfrequency dropout (range 70%-100% - factory set at 70%). (Internal)	Standard
5a	ACC.5a	Programmable load test function to simulate normal power failure (Maintained type). Keypad initiated. (Do not use with ACC.12a) (Internal)	Standard
5al	ACC.5al	Load test switch to simulate normal power failure. Lever operated switch. Legend plate marked "Auto" - "Test", Nameplate marked "Load Test Switch". (Do not use with ACC.12a, 5at, 5ak) (External)	Optional
5at	ACC.5at	Load test switch to simulate normal power failure. Toggle operated switch. Legend plate marked "Auto" - "Test", Nameplate marked "Load Test Switch". (Do not use with ACC.12a, 5al, 5ak) (External)	Optional
5ak	ACC.5ak	Load test switch to simulate normal power failure. Key operated switch, key removable in left position. Legend plate marked "Auto" - "Test", Nameplate marked "Load Test Switch". (Do not use with ACC.12a, 5al, 5at) (External)	Optional
5c	ACC.5c	Contact closure provided by customer to simulate normal power failure. (Internal)	Standard
5d	ACC.5d	Programmable override function to bypass the automatic transfer switch controls so that the transferred switch remains indefinitely connected to the emergency power source regardless of the condition of the normal power source. Keypad initiated. (Internal)	Standard
5dl	ACC.5dl	Override lever switch to bypass the automatic transfer switch controls so that the transferred switch will remain indefinitely connected to the emergency power source regardless of the condition of the normal power source. Nameplate marked "Maintain Emergency Position" - "Auto Re-transfer To Normal". (External)	Optional

5dt	ACC.5dt	Override toggle switch to bypass the automatic transfer switch controls so that the transferred switch will remain indefinitely connected to the emergency power source regardless of the condition of the normal power source. Nameplate marked “ Maintain Emergency Position” - “Auto Re-transfer To Normal”. (External)	Optional
5dk	ACC.5dk	Override key operated switch to bypass the automatic transfer switch controls so that the transferred switch will remain indefinitely connected to the emergency power source regardless of the condition of the normal power source. Nameplate marked “ Maintain Emergency Position” - “Auto Re-transfer To Normal”. (External)	Optional
6ap	ACC.6ap	Push button re-transfer-to-normal. Transfer switch will not return to normal automatically unless generator fails with normal power available. (Do not use with ACC.6b or ACC.2a) (External)	Optional
6b	ACC.6b	Programmable function to bypass (TD2) time delay on re-transfer-to-normal. Keypad initiated. (Do not use with ACC.6a) (Internal)	Standard
6bp	ACC.6bp	Push button to bypass (TD2) time delay on re-transfer-to-normal. (Do not use with ACC.6a) (External)	Optional
7	ACC.7	Contact to close on failure of normal source to initiate engine starting or other customer functions. (Internal)	Standard
7x	ACC.7x	Contact to close to indicate normal power has failed. This relay action is before engine starting time delay. (One contact standard) (External) With: Normal Status Relay	Optional
8	ACC.8	Contact to open on failure of normal source for customer functions. (ACC.7 & 8 can only be utilized in the following manner: (1) ACC.7 & (1) ACC.8, (2) ACC.7s, or (2) ACC.8s) (Internal)	Standard
9a	ACC.9a	Green LED to indicate switch in normal position. (Internal)	Standard

9ax	ACC.9ax	Amber LED to indicate normal power available. (Included with RTB/RTBDs - No Charge) (External)	Optional
9b	ACC.9b	Red LED to indicate switch in emergency position. (Internal)	Standard
9bx	ACC.9bx	Amber LED to indicate emergency power available. (Included with RTB/RTBDs - No Charge) (External)	Optional
9nbp	LT3	Green LED. Constant - Indicates load bypassed to the normal source. Isolating contacts closed, transfer switch energized. Flashing - Indicates load bypassed to the normal source. Isolating contacts open, transfer switch bypassed and isolated. (Included with RTB/RTBDs - No Charge) (External)	Standard
9ebp	LT4	Red LED. Constant - Indicates load bypassed to the emergency source. Isolating contacts closed, transfer switch energized. Flashing - Indicates load bypassed to the emergency source. Isolating contacts open, transfer switch bypassed and isolated. (Included with RTB/RTBDs - No Charge) (External)	Standard
9x	ACC. 9x	Red LED to indicate transfer switch is in the manual mode. (External)	Optional
10a	ACC.10a	12 volt dc battery charger (.05 to 2 amperes adjustable trickle charger). (External)	Optional
10b	ACC.10b	24 volt dc battery charger (.05 to 2 amperes adjustable trickle charger). (External)	Optional
NOTE: Use accessory "11" only for Model 2000 ATS processors (gold label on the back of the processor) revision "L" and higher.			
11	ACC.11	Plant exerciser with (10) seven-day events programmable for any day of the week (Mon., Tues., etc.) and (24) calendar events programmable for any month/day (03/01, 04/15, 10/24, etc.). To automatically exercise generating plant Programmable in one minute increments. Load Sets the exerciser to Load Test mode. The ATS load transfers to the emergency source during all exercise events. No-Load Sets the exerciser to No-Load Test mode. The engine-generator starts, but the ATS load does not transfer to the emergency source during all exercise events. Off The exerciser is bypassed and no exerciser operation takes place. On Places the exerciser in a functional mode that allows a keypad-initiated load test.	Standard

NOTE: Use accessory “11a” through “11dl” only for Model 2000 ATS processors (gold label on the back of the processor) PRIOR to revision “L”.			
11a	ACC.11a	Plant exerciser with (10) seven-day events programmable for any day of the week (Mon., Tues., etc.) and (24) calendar events programmable for any month/day (03/01, 04/15, 10/24, etc.). To automatically exercise generating plant without load transfer. Programmable in one minute increments. (Internal)	Standard
11b	ACC.11b	Plant exerciser with (10) seven-day events programmable for any day of the week (Mon., Tues., etc.) and (24) calendar events programmable for any month/day (03/01, 04/15, 10/24, etc.). To simulate a normal power failure and transfer the load to the generating plant. Programmable in one minute increments. (Internal)	Standard
11c	ACC.11c	Plant exerciser with (10) seven-day events programmable for any day of the week (Mon., Tues., etc.) and (24) calendar events programmable for any month/day (03/01, 04/15, 10/24, etc.). To automatically exercise generating plant Programmable in one minute increments. (Internal) With: Programmable function to select either “No Load” (Switch will not transfer), or “Load” (Switch will transfer) exercise period. Keypad initiated. (Internal)	Standard
11cl	ACC.11cl	Plant exerciser with (10) seven day events programmable for any day of the week (Mon., Tues., etc.) and (24) calendar events programmable for any month/day (03/01, 04/15, 10/24, etc.). To automatically exercise generating plant Programmable in one minute increments. (Internal) With: Lever switch to select either “No Load” (Switch will not transfer), or “Load” (Switch will transfer) exercise period. (External)	Optional

11d	ACC.11d	<p>Plant exerciser with (10) seven-day events programmable for any day of the week (Mon., Tues., etc.) and (24) calendar events programmable for any month/day (03/01, 04/15, 10/24, etc.). To automatically exercise generating plant Programmable in one minute increments.</p> <p>(Internal)</p> <p>With:</p> <p>Two-position exerciser mode On-Off programmable function. By placing this switch in the <i>Off</i> position, the exerciser is bypassed and no exerciser operation takes place. Placing this switch in the <i>On</i> position places the exerciser in a functional mode that allows a keypad initiated load test.</p> <p>(Internal)</p>	Optional
11dk	ACC.11dk	<p>Plant exerciser with (10) seven-day events programmable for any day of the week (Mon., Tues., etc.) and (24) calendar events programmable for any month/day (03/01, 04/15, 10/24, etc.). To automatically exercise generating plant Programmable in one minute increments.</p> <p>(Internal)</p> <p>With:</p> <p>Two-position exerciser mode On-Off key operated selector switch. By placing this switch in the <i>Off</i> position, the exerciser is bypassed and no exerciser operation takes place. Placing this switch in the <i>On</i> position places the exerciser in a functional mode to allow a load test.</p> <p>(External)</p>	Optional
11dl	ACC.11dl	<p>Plant exerciser with (10) seven-day events programmable for any day of the week (Mon., Tues., etc.) and (24) calendar events programmable for any month/day (03/01, 04/15, 10/24, etc.). To automatically exercise generating plant Programmable in one-minute increments.</p> <p>(Internal)</p> <p>With:</p> <p>Two-position exerciser mode On-Off lever operated selector switch. By placing this switch in the <i>Off</i> position, the exerciser is bypassed and no exerciser operation takes place. Placing this switch in the <i>On</i> position places the exerciser in a functional mode that allows a keypad initiated load test.</p> <p>(External)</p>	Optional
12a	ACC.12a	<p>Lever-operated four-position selector switch with <i>Load Test</i> – starts generator and transfers switch to the emergency source; <i>Automatic</i>, monitors normal and emergency sources to allow transfer to desired position; <i>Off</i> – does not allow generator to start; and <i>Hand Crank</i> – starts generator only/no load transfer positions.</p> <p>(Do not use with ACC.5a, 5al, 5at or 5ak)</p> <p>(External)</p>	Optional
12b	ACC.12b ACC.6e	<p>Two-position selector switch to select either automatic or manual re-transfer-to-normal operation.</p> <p>(External)</p> <p>With:</p> <p>Push button re-transfer-to-normal. Operable only when two-position selector switch is in the <i>Manual</i> position. Transfer switch does not return to normal automatically unless generator fails with normal power available.</p> <p>(External)</p>	Optional

12cl	<p>ACC.12cl</p> <p>ACC.6fp</p> <p>ACC.6gp</p>	<p>Two-position lever-operated selector switch that selects either automatic or manual transfer operation.</p> <p>(External)</p> <p>With:</p> <p>Push button re-transfer-to-normal. Operable only when two-position selector switch is in the <i>Manual</i> position.</p> <p>(External)</p> <p>With:</p> <p>Push button transfer-to-emergency. Operable only when two-position switch is in the <i>Manual</i> position.</p> <p>(External)</p>	Optional
12c	<p>ACC.12c</p> <p>ACC.6f</p> <p>ACC.6g</p>	<p>Programmable function to select either automatic or manual transfer operation.</p> <p>(Internal)</p> <p>With:</p> <p>Programmable function to select re-transfer-to-normal. Operable only when two-position selector switch is in the <i>Manual</i> position.</p> <p>(Internal)</p> <p>With:</p> <p>Programmable function to select transfer-to-emergency. Operable only when two-position switch is in the <i>Manual</i> position.</p> <p>(Internal)</p>	Optional
12x	ACC.12x	<p>Programmable function to select either No-Commit or Commit to transfer operation in the event of a normal power failure.</p> <p><i>Commit Position:</i></p> <p>When the Commit function is enabled, the transfer switch automatically transfers the load to the emergency source. This occurs even if normal power is restored.</p> <p><i>No-Commit Position:</i></p> <p>When the No-Commit function is enabled and the normal source fails, the TD1 timer begins timing and subsequently starts the engine-generator. In this case, the transfer switch does not transfer the load to the emergency source until it reaches its proper rated values. If the normal source returns prior to the transfer-to-emergency sequence initiation, then the transfer sequence aborts, and the ATS remains in the <i>Normal</i> position.</p> <p>Keypad initiated.</p> <p>(Internal)</p>	Standard

12xl	ACC.12xl	<p>Two-position lever-operated selector switch to select either No-Commit or Commit to transfer operation in the event of a normal power failure.</p> <p><i>Commit Position:</i></p> <p>When the switch is in the Commit position, the transfer switch automatically transfers the load to the emergency source. This occurs even if normal power is restored.</p> <p><i>No-Commit Position:</i></p> <p>When the switch is in the No-Commit position and the normal source fails, the TD1 timer begins timing and subsequently starts the engine-generator. In this case, the transfer switch does not transfer the load to the emergency source until it reaches its proper rated values. If the normal source returns prior to the transfer-to-emergency sequence initiation, then the transfer sequence aborts, and the ATS remains in the Normal position.</p> <p>(External)</p>	Optional
12xk	ACC.12xk	<p>Two-position key-operated selector switch to select either No-Commit or Commit to transfer operation in the event of a normal power failure.</p> <p><i>Commit Position:</i></p> <p>When the switch is in the Commit position, the transfer switch automatically transfers the load to the emergency source. This occurs even if normal power is restored.</p> <p><i>No-Commit Position:</i></p> <p>When the switch is in the No-Commit position and the normal source fails, the TD1 timer begins timing and subsequently starts the engine-generator. In this case, the transfer switch does not transfer the load to the emergency source until it reaches its proper rated values. If the normal source returns prior to the transfer-to-emergency sequence initiation, then the transfer sequence aborts, and the ATS remains in the Normal position.</p> <p>(External)</p>	Optional

12dx	PSSS	<p>Preferred source selector switch to select either source-1 or source-2 supply as the preferred source.</p> <p><u>OPERATION OF PREFERRED SOURCE SELECTOR SWITCH:</u></p> <p>The Preferred Source selector switch allows periodic selection between two available sources. The source selected to supply the load is considered the preferred source, and the second available source is considered the alternate source.</p> <p>Operation of the PSSS from source-1 to source-2 or from source-2 to source-1 is a manual function only. The load is momentarily interrupted while the transfer switch contacts are in motion.</p> <p>In the event of a source-1 power outage, or load test operation (ACC.5a) with source-1 as the preferred source, control circuitry allows transfer to source-2. If re-transfer to source-1 is desired, the PSSS should be left in the source-1 position. When the source-1 supply returns and after the re-transfer time delay expires, the switch automatically re-transfers to source-1.</p> <p>A similar operation exists when the PSSS is placed in the source-2 position with source-1 as the alternative supply.</p> <p><i>Note: During a load test operation (ACC. 5A), use the Preferred Source Selector switch until the completion of the load test sequence.</i></p>	Optional
14a	ACC.14a	<p>Auxiliary contact closed in normal position wired to terminal strip. (One contact standard)</p> <p>(External)</p>	Optional
14b	ACC.14b	<p>Auxiliary contact closed in emergency position wired to terminal strip. (One contact standard)</p> <p>(External)</p>	Optional
14x	ACC.14x	<p>Auxiliary contact to indicate ATS is in the <i>Center-Off</i> position. Wired to terminal strip.</p> <p>(Use with dual motor switches only)</p> <p>(External)</p>	Optional
16t	ACC.16t	<p>Switch to disconnect the engine starting contact. Toggle operated switch. Nameplate marked "Engine Lockout Sw./Lockout - Auto".</p> <p>(External)</p>	Optional
16l	ACC.16l	<p>Switch to disconnect the engine starting contact. Lever operated switch. Legend plate marked "Lockout" - "Auto", Nameplate marked "Engine Lockout Switch".</p> <p>(External)</p>	Optional
16k	ACC.16k	<p>Switch to disconnect the engine starting contact. Key-operated switch. Legend plate marked "Lockout" - "Auto", Nameplate marked "Engine Lockout Switch".</p> <p>(External)</p>	Optional
17	ACC.17	<p>Circuit for area protection</p> <p>(Internal)</p>	Standard
18a	AM CT	<p>Ammeter to read current in phase two only of load circuit - 2% accuracy.</p> <p>(External)</p>	Optional

18b	AM CT	Ammeter with four-position selector switch marked “Off-1-2-3” to read current in all three phases of load circuit - 2% accuracy. (External)	Optional
19a	VM	Voltmeter connected across phase one and phase three of the emergency source (self contained type VM) - 2% accuracy. (External)	Optional
19b	VM	Voltmeter with four-position selector switch marked “Off, 1-2, 2-3, 3-1”. Three-phase type to read phase-to-phase voltage of the emergency source - 2% accuracy. (External)	Optional
19bd	VM/FM	Digital voltmeter, three-phase type to read phase-to-phase voltage and frequency on the normal and the emergency source - 1% accuracy. (Internal)	Standard
19c	VM	Voltmeter with seven-position selector switch marked “3-1, 2-3, 1-2, Off, 1, 2, 3”. Three-phase type to read phase-to-phase and phase-to-neutral voltage of emergency source - 2% accuracy. (External)	Optional
21x	ESR	Normally open contact to close whenever the generator is available (One contact standard) (External) With Emergency Status Relay	Optional
22	ACC.22	20A, fused circuit energized from emergency source (line-to-line). (External)	Optional
22x	ACC.22x	20A, fused circuit energized from normal source (line-to-line). (External)	Optional
22xx	ACC.22xx	20A, fused circuit energized from load source (line-to-line). (External)	Optional
23a	TDMI	(2) Time delay form “C” contacts that change state simultaneously just (milliseconds) prior to transfer in either direction. These contacts reset after a time delay (programmable 0-9999 seconds) after transfer. Factory set at 5 seconds. (Internal)	Standard
23b	TDBT	Consisting of TDBT function to provide (2) form “C” contacts that change state simultaneously 5 seconds (0-9999) before transfer in either direction and reset instantaneously after transfer. Factory set at 5 seconds. (Internal)	Standard
23c	TDBT TDMI	Consisting of TDBT & TDMI function to provide (2) form “C” contacts that change state simultaneously 5 seconds (programmable 0-9999) seconds) before transfer in either direction and reset 5 seconds (programmable 0-9999) after the ATS has completed transfer. (Internal)	Standard
26	ACC.26	Over voltage sensing of the emergency source (programmable range: 100%-120%) factory set at 120% pickup, 110% dropout. Over frequency sensing (programmable range: 100%-120%) factory set at 120% pickup, 110% dropout. Voltage differential between phases (programmable range: 5%-20%) factory set at 20%. (Internal)	Standard

27a	SCR	Automatic synchronizing check relay function to prevent re-transfer from emergency to normal until the normal and emergency sources are within acceptable limits. (Used with single motor switches only) (Do not use with ACC.2d or ACC.27b) (Internal)	Standard
27b	SCR	Automatic synchronizing check relay function to prevent transfer from normal to emergency or re-transfer from emergency to normal until the normal and emergency sources are within acceptable limits. (Used with single motor switches only) (Do not use with ACC.2d or ACC.27a) (Internal)	Standard
28	HSB, HSL, HA	Audible alarm to indicate switch in emergency position with alarm silence circuit and LED to indicate that alarm has been silenced. Nameplate for light marked “Audible Alarm Silenced”, Nameplate for horn marked “Audible Alarm”, and Nameplate for push button marked “Audible Alarm Silence Push Button”. (External)	Optional
30	ACC30	If normal power fails, the transfer switch bypasses any or all of the following timers, if installed: TD3, TETD, and TDBT. (Internal)	
THS/ST1	THS/ST1	Thermostat and strip heater assembly. (External)	Optional
BTR	BTR	Block transfer function energized by 24 Vdc signal from generator control switchgear to allow transfer-to-emergency with keypad initiated bypass block transfer-to-emergency. (Operating voltage: 24 vdc-48 Vdc) (Internal)	Standard
BTRK	BTRK	Block transfer function energized by 24 Vdc signal from generator control switchgear to allow transfer-to-emergency. This accessory is supplied with two position spring-return keyed-operator to bypass the block transfer relay, and is used for manual operation. (Operating voltage: 24 vdc-48 Vdc) (External)	Optional
LSR	LSR	Load shed function energized by 24 Vdc signal from generator control switchgear to disconnect the load from the emergency source when an overload condition occurs. An automatic load shed feature is provided. Whenever LSR is enabled the emergency source frequency is compared to the load shed frequency pick-up and drop-out values. If the emergency frequency is less than the load shed frequency drop-out value (93%, 56Hz) and the load shed timer has expired, then a load shed condition is initiated. The load shed timer is adjustable from 0-9999 seconds and factory set at 1 second. Once the emergency frequency is greater than or equal to the load shed frequency pick-up value (96%, 58Hz) the load shed condition is removed. (Operating voltage: 24 vdc-48 Vdc) (Internal)	Standard

LTR	LTR	Load test function energized by 24 Vdc signal from generator control switchgear to simulate a normal power failure. (Operating voltage: 24 vdc-48 Vdc) (Internal)	Standard
PRR	PRR	Normal/Emergency Phase Sequence	Optional
PSR	PSR	Peak shave function energized by 24 Vdc signal from generator control switchgear. This function starts the emergency generator and transfers the ATS to the emergency source, reducing the utility supply to the building. After this peak shave signal is removed, the ATS re-transfers to the normal supply by bypassing the re-transfer time delay. (Operating voltage: 24 vdc-48 Vdc) (Internal)	Standard
EMO	EMO	External manual operator.	Optional
MDS	MDS	Motor disconnect switch to disable the ATS motor operator when placed in the disconnect position. Key-operated switch, key removable in both positions. Legend plate marked “Auto-Disconnect”. Nameplate marked “Motor Disconnect Switch”. (External)	Optional
IS	IS	Contact to close to indicate the transfer switch is isolated. (RTB only)	Optional
BSN	BSN	Contact to close to indicate the bypass switch is in the bypass-to-normal position. (RTB only)	Optional
BSE	BSE	Contact to close to indicate the bypass switch is in the bypass-to-emergency position. (RTB only)	Optional
CPUR	CPUR	Contact to close to indicate CPU is not running. (External)	Optional